

Foreword

Welcome to the growing family of new NISSAN owners. This vehicle has been delivered to you with confidence. It has been produced using the latest techniques and strict quality control.

This manual was prepared to help you understand the operation and maintenance of your vehicle so that you may enjoy many kilometers (miles) of driving pleasure. Please read through this manual before operating your vehicle.

A separate Warranty Information & Maintenance Booklet explains details about the warranties covering your vehicle.

Your NISSAN dealer knows your vehicle best. When you require any service or have any questions, we will be glad to assist you with the extensive resources available for you.

IMPORTANT SAFETY INFORMATION

Reminders for safety!

Follow these important driving rules to help ensure a safe and complete trip for you and your passengers!

- **NEVER drive under the influence of alcohol or drugs.**
- **ALWAYS observe posted speed limits and never drive too fast for conditions.**
- **ALWAYS use your seat belts and appropriate child restraint systems. Preteen children should be seated in the rear seat.**
- **ALWAYS provide information about the proper use of vehicle safety features to all occupants of the vehicle.**
- **ALWAYS review this Owner's Manual for important safety information.**

When reading the manual

This manual includes information for all options available on this model. Therefore, you may find some information that does not apply to your vehicle.

All information, specifications and illustrations in this manual are those in effect at the time of printing. NISSAN reserves the right to change specifications or designs without notice and without obligation.

MODIFICATION OF YOUR VEHICLE

This vehicle should not be modified. Modification could affect its performance, safety or durability, and may even violate governmental regulations. In addition, damage or performance problems resulting from modifications may not be covered under NISSAN warranties.

Read first — then drive safely

Before driving your vehicle, read this Owner's Manual carefully. This will ensure familiarity with controls and maintenance requirements, assisting you in the safe operation of your vehicle.

Throughout this manual we have used the symbol  followed by the word **WARNING**. This is used to indicate the presence of a hazard that could cause death or serious personal injury. To avoid or reduce the risk, the procedures must be followed precisely.

The symbol  followed by the word **CAUTION** is also used throughout this manual to indicate the presence of a hazard that could cause minor or moderate personal injury or damages to your vehicle. To avoid or reduce the risk, the procedures must be followed carefully.

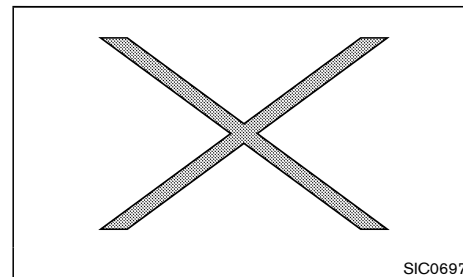

If you see this symbol, it means **“Do not do this”** or **“Do not let this happen”**.



If you see a symbol similar to these in an illustration, it means the arrow points to the front of the vehicle.

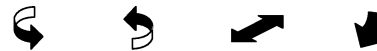

Arrows in an illustration that are similar to these indicate movement or action.



Arrows in an illustration that are similar to these call attention to an item in the illustration.



Bluetooth® is a trademark owned by Bluetooth SIG, Inc., and licensed to Visteon Corporation.

© 2014 NISSAN MOTOR CO., LTD.

Table of Contents

Illustrated table of contents	0
Safety — seats, seat belts and supplemental restraint system	1
Instruments and controls	2
Pre-driving checks and adjustments	3
Heater and air conditioner, and audio system	4
Starting and driving	5
In case of emergency	6
Appearance and care	7
Maintenance and do-it-yourself	8
Technical information	9
Index	10

0 Illustrated table of contents

Seats, seat belts and Supplemental Restraint System (SRS)	0-2	Instrument panel	0-8
Exterior front	0-3	Left-Hand Drive (LHD) models	0-8
Exterior rear	0-4	Right-Hand Drive (RHD) models	0-9
Passenger compartment	0-5	Meters and gauges	0-10
Cockpit	0-6	Engine compartment	0-11
Left-Hand Drive (LHD) models	0-6	MRA8DE engine model	0-11
Right-Hand Drive (RHD) models	0-7	MR16DDT engine model	0-12
		HR16DE engine model	0-13

SEATS, SEAT BELTS AND SUPPLEMENTAL RESTRAINT SYSTEM (SRS)

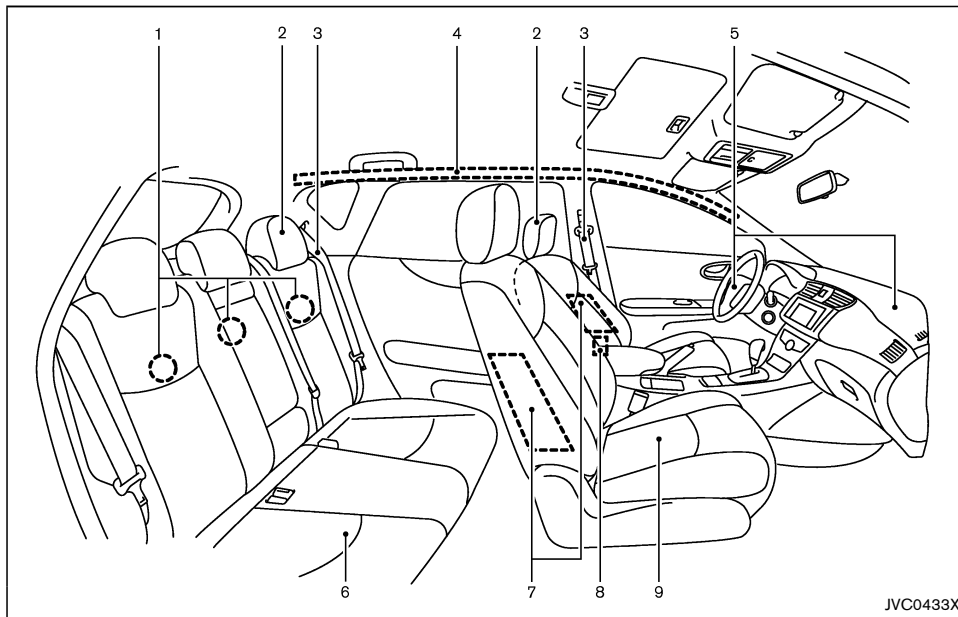

- | | |
|--|--|
| 1. Child restraint anchor points* (for top tether strap child restraint) (Page 1-12) | 7. Supplemental side-impact air bags* (P.1-18) |
| 2. Head restraints (P.1-5) | 8. Pre-tensioner seat belt system* (P.1-26) |
| 3. Seat belts (P.1-7) | 9. Front seats (P.1-2) |
| 4. Supplemental curtain side-impact air bags* (P.1-18) | *: if equipped |
| 5. Supplemental front-impact air bags (P.1-18) | |
| 6. Rear seats (P.1-3) | |
| — Child restraints (P.1-12) | |

EXTERIOR FRONT

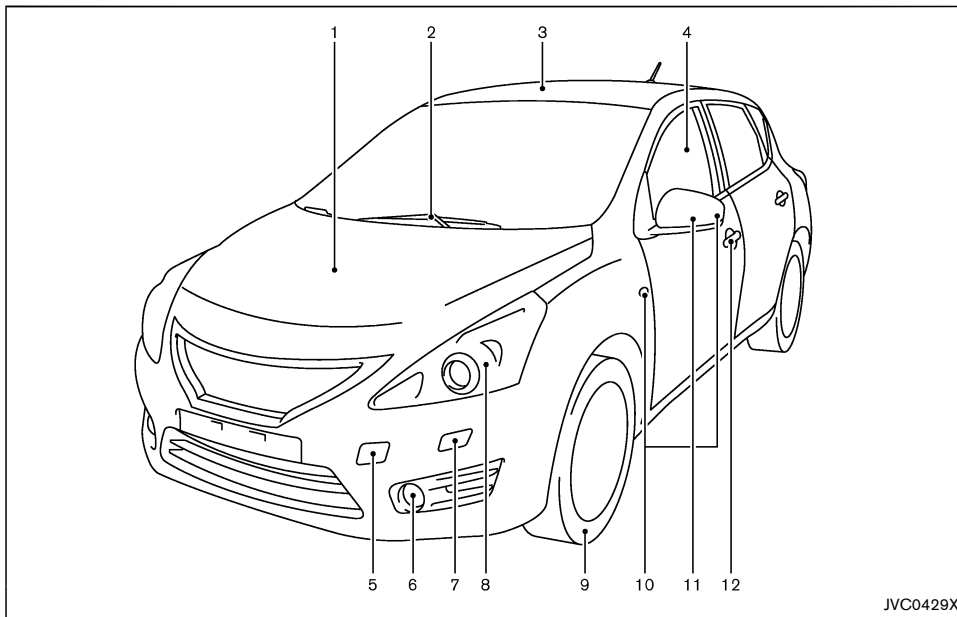

1. Engine hood (P.3-14)
2. Windshield wiper and washer
 - Switch operation (P.2-20)
 - Blade replacement (P.8-15)
 - Window washer fluid (P.8-17)
3. Sunroof* (P.2-24)
4. Power windows (P.2-22)
5. Recovery hook (P.6-9)
6. Fog lights*
 - Switch operation (P.2-19)
7. Headlight cleaners* (P.2-20)
8. Headlights and turn signal lights
 - Switch operation (P.2-17)
 - Bulb replacement (P.8-23)
9. Tires
 - Tires and wheels (P.8-31, P.9-7)
 - Flat tire (P.6-2)
 - Tire placard (P.9-9)

10. Side turn signal lights (on the front fender or the outside rearview mirror)
 - Switch operation (P.2-19)
 - Bulb replacement (P.8-24)
11. Outside mirrors (P.3-18)
12. Doors
 - Keys (P.3-2)
 - Door locks (P.3-3)
 - Intelligent Key system* (P.3-7)
 - Remote keyless entry system* (P.3-5)
 - Security system* (P.3-14)

*: if equipped

JVC0429X

EXTERIOR REAR

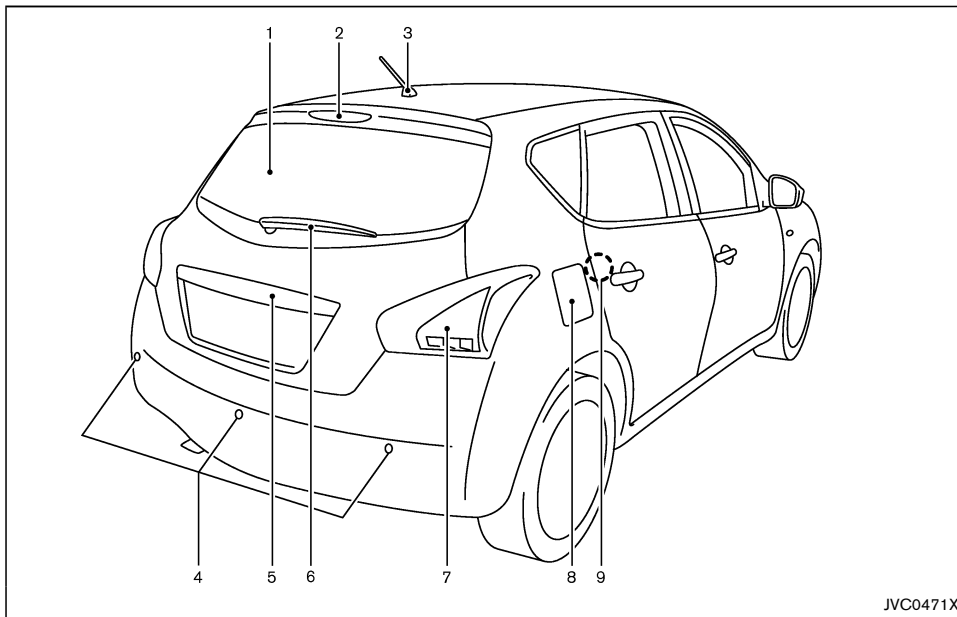

JVC0471X

- | | |
|--|--|
| 1. Rear window defogger (P.2-21) | — Window washer fluid (P.8-17) |
| 2. High-mounted stop light (P.8-24) | 7. Rear combination lights |
| 3. Antenna (P.4-18) | — Switch operation (P.2-17) |
| 4. Sonar (parking sensor) system* (P.5-19) | — Bulb replacement (P.8-24) |
| 5. Back door (P.3-15) | 8. Fuel filler lid |
| — Intelligent Key system* (P.3-7) | — Operation (P.3-17) |
| — Remote keyless entry system* (P.3-5) | — Fuel information (P.9-4) |
| — Rearview camera* (P.4-2) | 9. Child safety rear door lock (P.3-5) |
| 6. Rear window wiper and washer | *: if equipped |
| — Switch operation (P.2-20) | |

PASSENGER COMPARTMENT

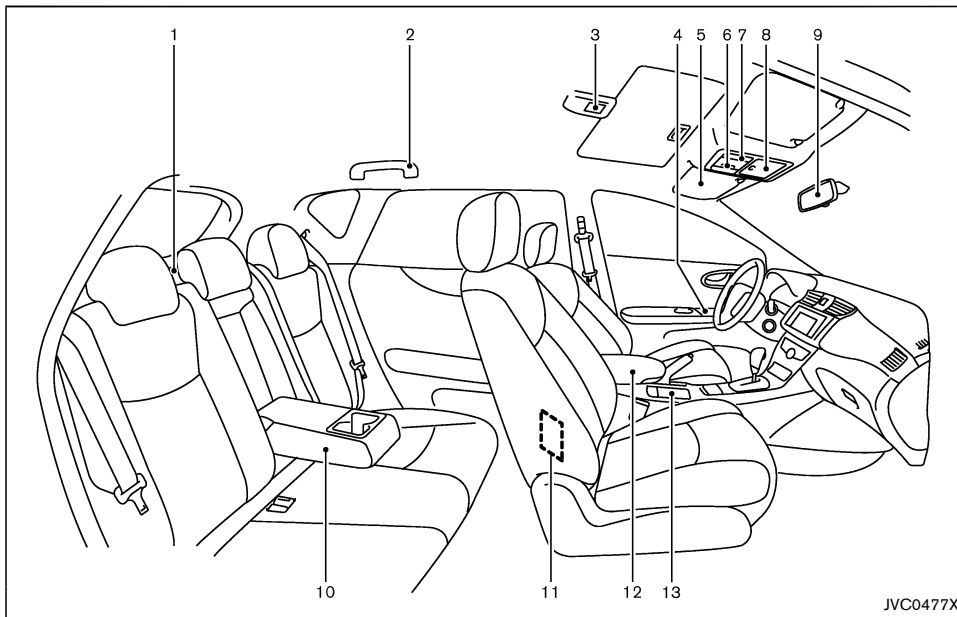

- | | |
|----------------------------------|------------------------------------|
| 1. Cargo cover (P.2-28) | 8. Sunglasses holder (P.2-27) |
| 2. Coat hook* (P.2-28) | 9. Inside rearview mirror (P.3-18) |
| 3. Room light (P.2-29) | 10. Rear armrest* (P.1-4) |
| 4. Door armrest | — Rear cup holders* (P.2-27) |
| — Power window switch (P.2-22) | 11. Ashtray* (P.2-25) |
| — Power door lock switch (P.3-4) | 12. Console box (P.2-26) |
| 5. Sun visors (P.2-29, P.3-19) | - Front armrest* (P.1-4) |
| 6. Sunroof switch* (P.2-24) | - USB memory operation* (P.4-25) |
| 7. Map lights (P.2-30) | - iPod player operation* (P.4-26) |
| | - USB/AUX connector* (P.4-28) |

13. Front cup holders (P.2-27)

*: if equipped

COCKPIT

LEFT-HAND DRIVE (LHD) MODELS

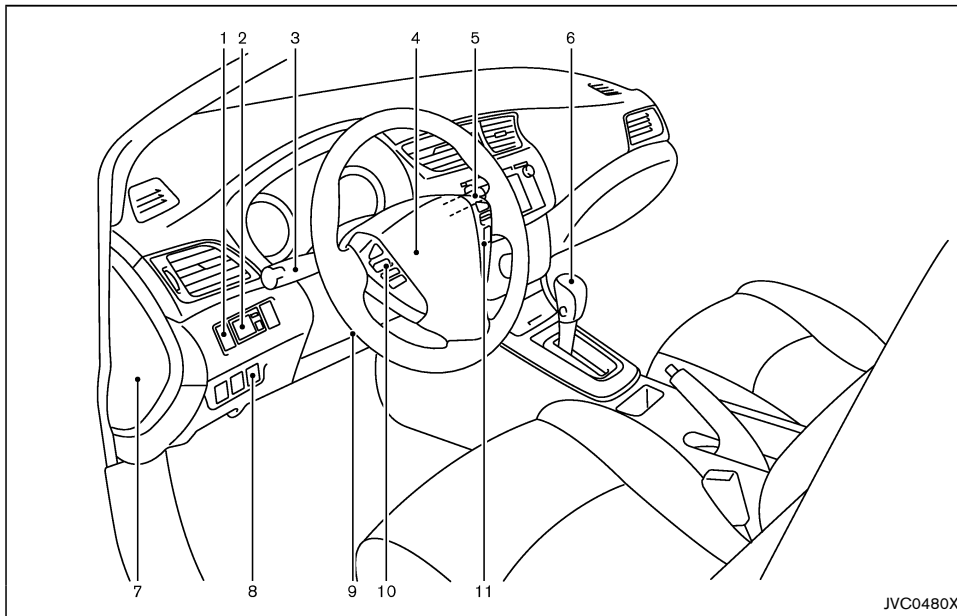

1. Instrument brightness control switch (P.2-7)
2. Outside rearview mirror control switch (P.3-18)
3. Headlight, fog light* and turn signal switch
 - Headlight (P.2-17)
 - Turn signal (P.2-19)
 - Fog light* (P.2-19)
4. Steering wheel
 - Electric power steering system (P.5-22)

- Horn (P.2-22)
- Driver's supplemental front-impact air bag (P.1-18)
- 5. Wiper and washer switch (P.2-20)
- 6. Shift lever
 - Continuously Variable Transmission (CVT) (P.5-9)
 - Manual Transmission (MT) (P.5-13)

7. Fuse box cover (P.8-22)
8. Vehicle Dynamic Control (VDC) OFF switch* (P.5-14)
9. Tilting/telescopic steering wheel lever (P.3-17)
10. Steering-wheel-mounted controls (left side)
 -  switch (odometer and trip computer) (P.2-10)
 - Audio system* (P.4-28)
 - Bluetooth® Hands-Free Phone System (without navigation system)* (P.4-29)
 - Bluetooth® Hands-Free Phone System (with navigation system)**
11. Steering-wheel-mounted controls (right side)
 - Cruise control switches* (P.5-16)

*: if equipped

** : Refer to the separate NISSAN Connect Owner's Manual (if equipped).

RIGHT-HAND DRIVE (RHD) MODELS

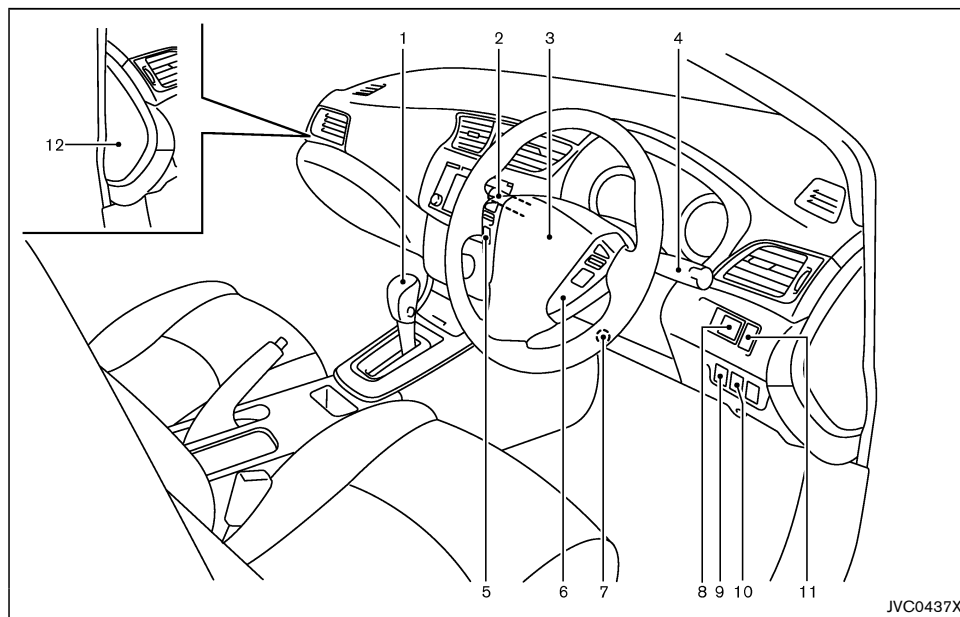

1. Shift lever
 - Continuously Variable Transmission (CVT) (P.5-9)
 - Manual Transmission (MT) (P.5-13)
2. Wiper and washer switch (P.2-20)
3. Steering wheel
 - Electric power steering system (P.5-22)
 - Horn (P.2-22)
4. Headlight, fog light* and turn signal switch
 - Headlight (P.2-17)
 - Turn signal (P.2-19)
 - Fog light* (P.2-19)
5. Steering-wheel-mounted controls (left side)
 -  switch (odometer and trip computer) (P.2-10)
 - Driver's supplemental front-impact air bag (P.1-18)

- Audio system* (P.4-28)
 - Bluetooth® Hands-Free Phone System (without navigation system)* (P.4-29)
 - Bluetooth® Hands-Free Phone System (with navigation system)**
6. Steering-wheel-mounted controls (right side)
 - Cruise control switches* (P.5-16)
 7. Tilting/telescopic steering wheel lever (P.3-17)
 8. Outside rearview mirror control switch (P.3-18)
 9. Vehicle Dynamic Control (VDC) OFF switch* (P.5-14)
 10. Headlight aiming control switch* (P.2-18)
 11. Instrument brightness control switch (P.2-7)
 12. Fuse box cover (P.8-22)
- *: if equipped
 **: Refer to the separate NISSAN Connect Owner's Manual (if equipped).

INSTRUMENT PANEL

LEFT-HAND DRIVE (LHD) MODELS

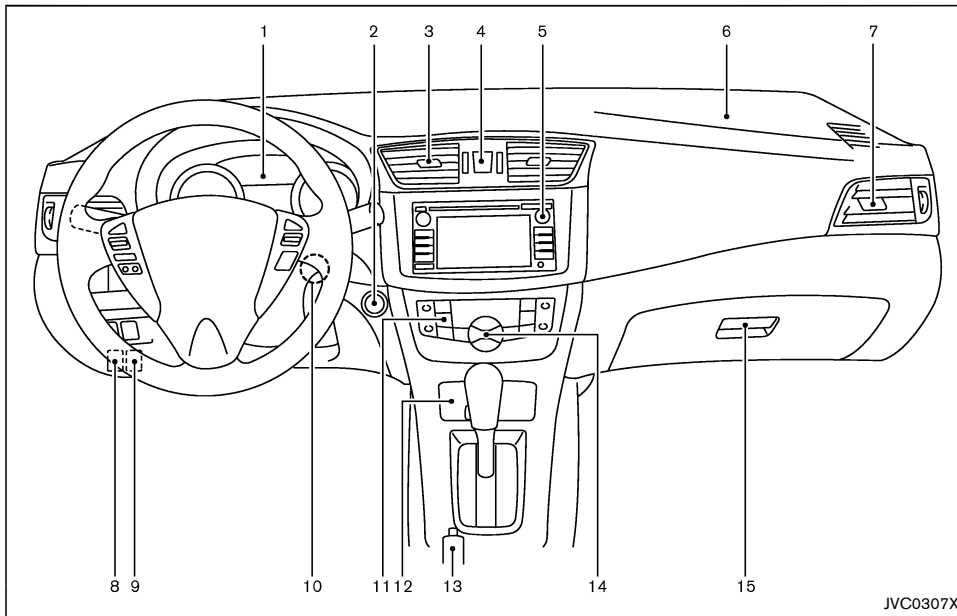

- | | |
|---|---|
| 1. Meters and gauges (P.2-6) | 8. Fuel filler lid release handle (P.3-17) |
| 2. Push-button ignition switch (models with Intelligent Key system) (P.5-5) | 9. Hood release handle (P.3-14) |
| 3. Center ventilator (P.4-5) | 10. Ignition switch (models without Intelligent Key system) (P.5-4) |
| 4. Hazard indicator flasher switch (P.6-2) | 11. Defogger switch (P.2-21) |
| 5. Audio system* (P.4-11) or Navigation system** | 12. Ashtray and cigarette lighter (P.2-25) |
| 6. Passenger's front-impact air bag (P.1-18) | 13. Parking brake (P.3-19, 8-12) |
| 7. Side ventilator (P.4-5) | 14. Heater and air conditioner control (P.4-6) |

15. Glove box (P.2-26)

*: if equipped

** : Refer to the separate NISSAN Connect Owner's Manual (if equipped).

RIGHT-HAND DRIVE (RHD) MODELS

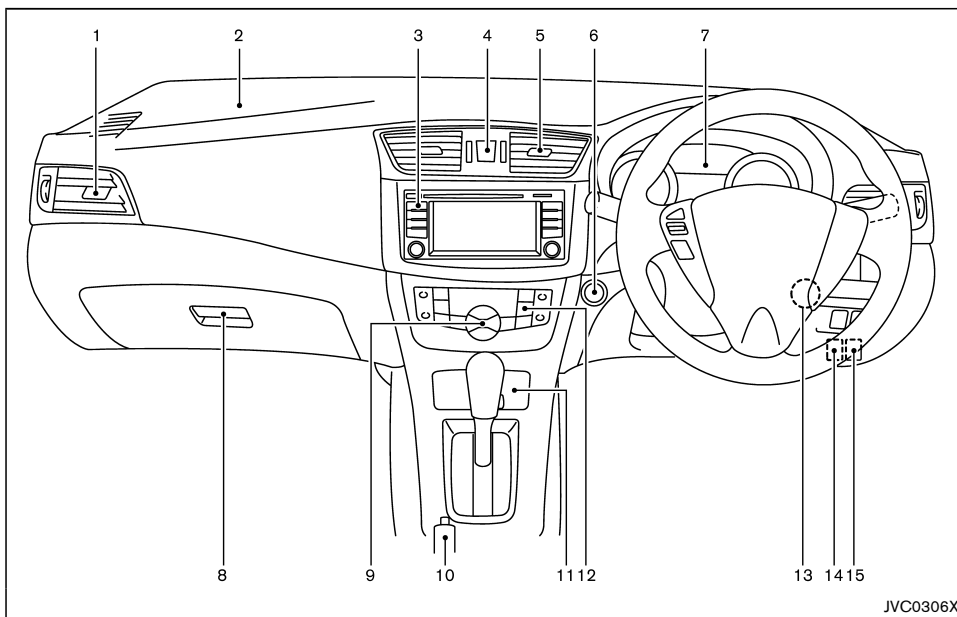

- | | |
|---|---|
| 1. Side ventilator (P.4-5) | 8. Glove box (P.2-26) |
| 2. Passenger's front-impact air bag (P.1-18) | 9. Heater and air conditioner control (P.4-6) |
| 3. Audio system* (P.4-11) or Navigation system** | 10. Parking brake (P.3-19, 8-12) |
| 4. Hazard indicator flasher switch (P.6-2) | 11. Power outlet* (P.2-25) or Ashtray and cigarette lighter* (P.2-25) |
| 5. Center ventilator (P.4-5) | 12. Defogger switch (P.2-21) |
| 6. Push-button ignition switch (models with Intelligent Key system) (P.5-5) | 13. Ignition switch (models without Intelligent Key system) (P.5-4) |
| 7. Meters and gauges (P.2-6) | |

14. Hood release handle (P.3-14)
15. Fuel filler lid release handle (P.3-17)

*: if equipped

** : Refer to the separate NISSAN Connect Owner's Manual (if equipped).

METERS AND GAUGES

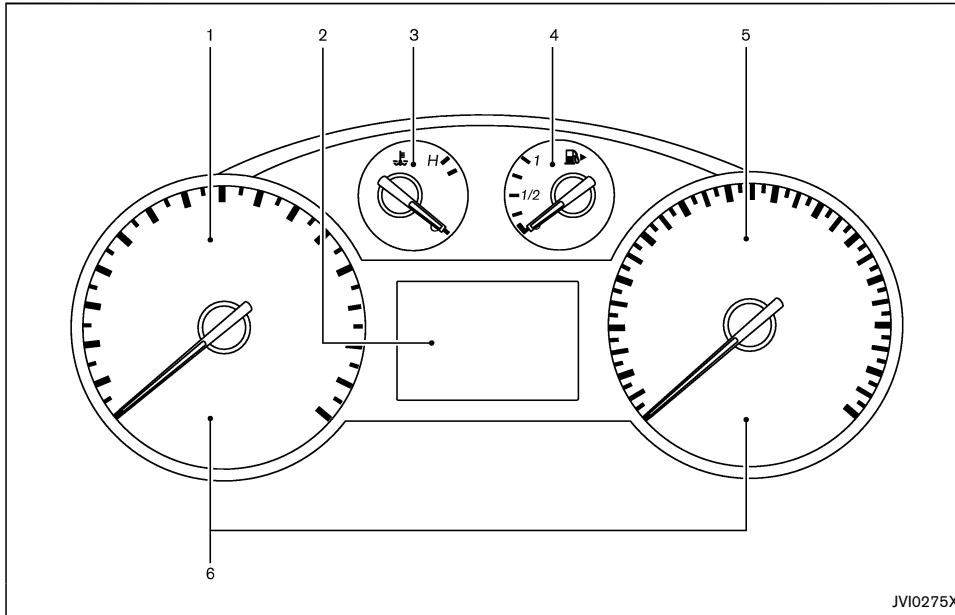

JVI0275X

- | | |
|---|--|
| 1. Tachometer (P.2-6) | 5. Speedometer (P.2-6) |
| 2. Vehicle information display (P.2-8)
— Odometer/twin trip odometer (P.2-10)
— Outside air temperature (P.2-8)
— Continuously Variable Transmission (CVT) position indicator* (P.2-8, P.5-9)
— Trip computer (P.2-8) | 6. Warning/indicator lights (P.2-11)
*: if equipped |
| 3. Engine coolant temperature gauge (P.2-7) | |
| 4. Fuel gauge (P.2-7) | |

ENGINE COMPARTMENT

MRA8DE ENGINE MODEL

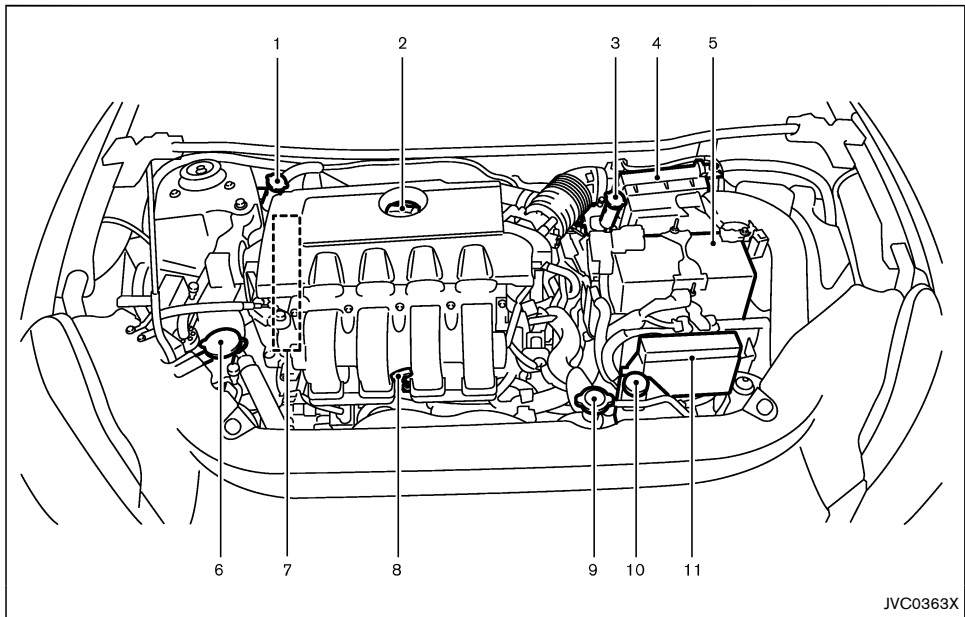

- | | |
|--|---|
| 1. Brake and clutch* fluid reservoir (P.8-13)
— Right-Hand Drive (RHD) models | 6. Window washer fluid reservoir (P.8-17) |
| 2. Engine oil filler cap (P.8-9) | 7. Engine drive belt location (P.8-11) |
| 3. Brake fluid reservoir (P.8-13)
— Left-Hand Drive (LHD) models | 8. Engine oil dipstick (P.8-9) |
| 4. Air cleaner (P.8-15) | 9. Radiator cap (P.8-7)
— Vehicle overheat (P.6-7) |
| 5. Battery (P.8-18)
— Jump starting (P.6-5) | 10. Engine coolant reservoir (P.8-7) |
| | 11. Fuse/fusible link holders (P.8-21) |

*: For Manual Transmission (MT) models

MR16DDT ENGINE MODEL

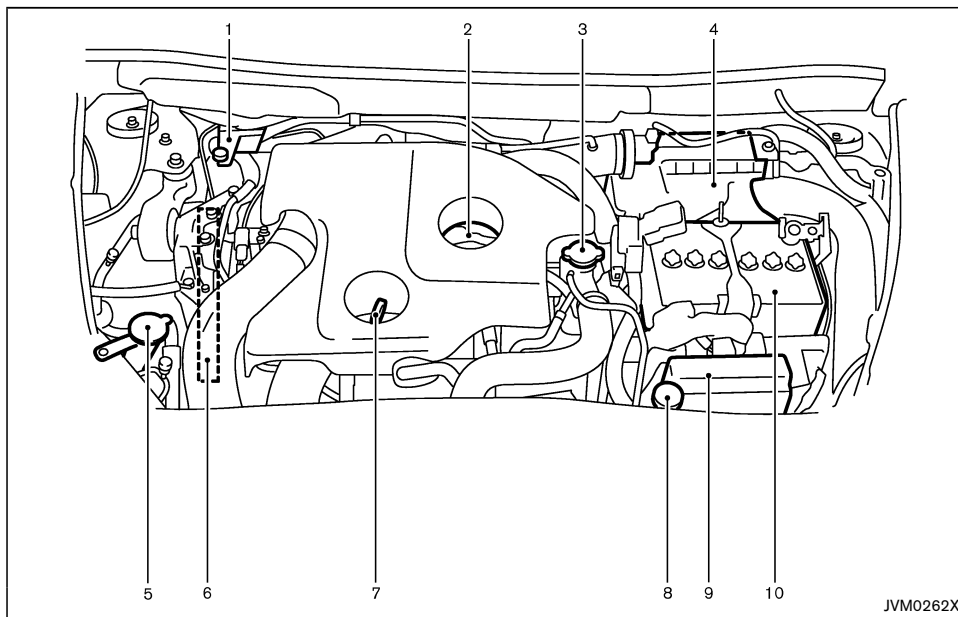

- | | |
|---|---------------------------------------|
| 1. Brake and clutch* fluid reservoir (P.8-13) | 8. Engine coolant reservoir (P.8-7) |
| 2. Engine oil filler cap (P.8-9) | 9. Fuse/fusible link holders (P.8-21) |
| 3. Radiator cap (P.8-7) | 10. Battery (P.8-18) |
| — Vehicle overheat (P.6-7) | — Jump starting (P.6-5) |
| 4. Air cleaner (P.8-15) | |
| 5. Window washer fluid reservoir (P.8-17) | |
| 6. Engine drive belt location (P.8-11) | |
| 7. Engine oil dipstick (P.8-9) | |

*: For Manual Transmission (MT) model

HR16DE ENGINE MODEL

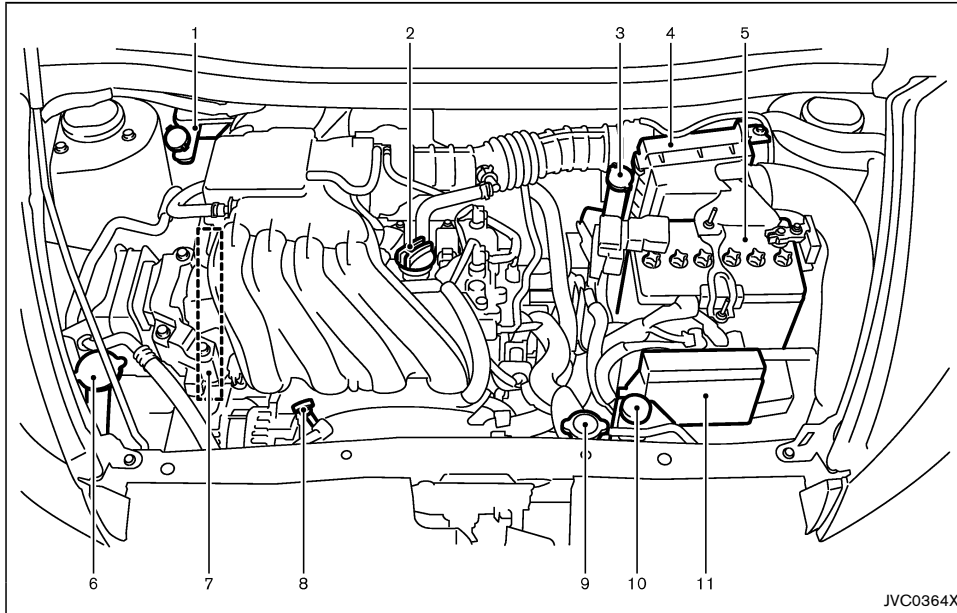

- | | |
|--|---|
| 1. Brake and clutch* fluid reservoir (P.8-13)
— Right-Hand Drive (RHD) models | 6. Window washer fluid reservoir (P.8-17) |
| 2. Engine oil filler cap (P.8-9) | 7. Engine drive belt location (P.8-11) |
| 3. Brake and clutch* fluid reservoir (P.8-13)
— Left-Hand Drive (LHD) models | 8. Engine oil dipstick (P.8-9) |
| 4. Air cleaner (P.8-15) | 9. Radiator cap (P.8-7)
— Vehicle overheat (P.6-7) |
| 5. Battery (P.8-18)
— Jump starting (P.6-5) | 10. Engine coolant reservoir (P.8-7) |
| | 11. Fuse/fusible link holders (P.8-21) |

*: For Manual Transmission (MT) models

MEMO

1 Safety — seats, seat belts and supplemental restraint system

Seats	1-2	Three-point type seat belts	1-9
Front seats	1-2	Two-point type seat belts (if equipped)	1-11
Rear seats	1-3	Seat belt maintenance	1-11
Armrest	1-4	Child restraints	1-12
Head restraints	1-5	Precautions on child restraint usage	1-12
Adjustable head restraint	1-5	Child restraint anchorage (if equipped)	1-12
Non-adjustable head restraint	1-5	Child restraint installation using 3-point type seat belt (if equipped)	1-13
Remove	1-5	Child restraint installation using 2-point type seat belt (if equipped)	1-16
Install	1-6	Supplemental Restraint System (SRS)	1-18
Adjust	1-6	Precautions on Supplemental Restraint System (SRS)	1-18
Seat belts	1-7	Supplemental air bag systems	1-22
Precautions on seat belt usage	1-7	SRS air bag deployment conditions	1-24
Child safety	1-8	Pre-tensioner seat belt system (if equipped)	1-26
Pregnant women	1-9	Repair and replacement procedure	1-26
Injured persons	1-9		
Center mark on seat belts	1-9		

SEATS

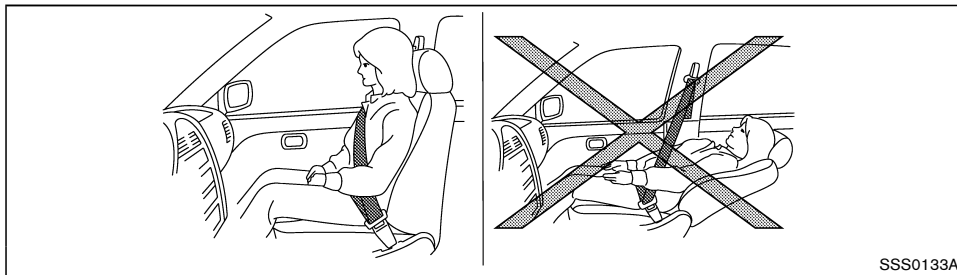

WARNING:

- Do not drive and/or ride in the vehicle with the seatback reclined. This can be dangerous. The shoulder belt will not be properly against the body. In an accident, you and your passengers could be thrown into the shoulder belt and receive neck or other serious injuries. You and your passengers could also slide under the lap belt and receive serious injuries.
- For the most effective protection while the vehicle is in motion, the seatback should be upright. Always sit well back in the seat and adjust the seat belt properly. (See "Seat belts" (P.1-7).)

CAUTION:

When adjusting the seat positions, be sure not to contact any moving parts to avoid possible injuries and/or damages.

FRONT SEATS

WARNING:

Do not adjust the driver's seat while driving so that full attention may be given to vehicle operation.

Manual seat adjustment

WARNING:

After adjusting a seat, gently shake the seat to confirm that the seat is locked securely. If the seat is not locked securely, it may move suddenly and could cause the loss of control of the vehicle.

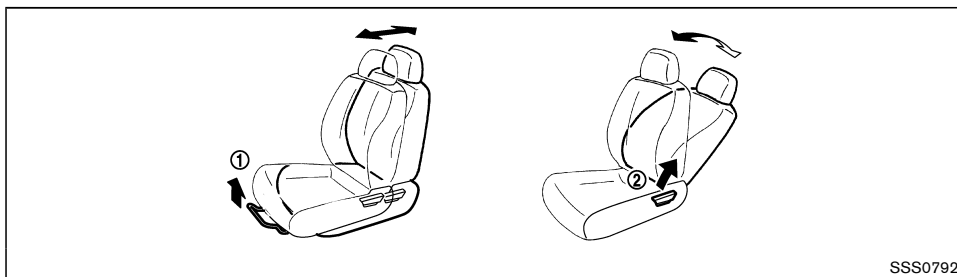

Forward and backward:

1. Pull up the adjusting lever ①.
2. Slide the seat to the desired position.
3. Release the adjusting lever to lock the seat in position.

Reclining:

1. Pull up the adjusting lever ②.
2. Tilt the seatback to the desired position.
3. Release the adjusting lever to lock the seatback in position.

The reclining feature allows the adjustment of the seatback for occupants of different sizes to help obtain the proper seat belt fit. (See “Seat belts” (P.1-7).)

The seatback may be reclined to allow occupants to rest when the vehicle is parked.

Seat lifter (if equipped):

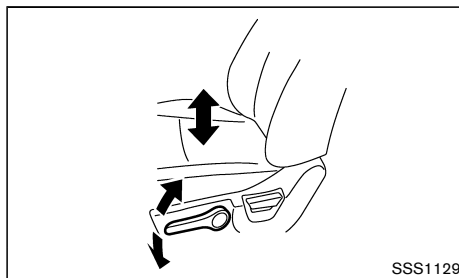

Pull up or push down the adjusting lever to adjust the seat height until the desired position is achieved.

REAR SEATS

Folding

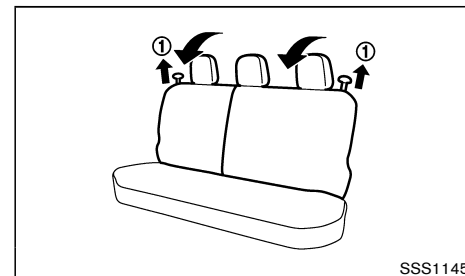

Before folding the rear seats:

Secure the seat belts on the seat belt hooks on the side wall. (See “Seat belt hooks” (P.1-10).)

To fold the seatback, pull the adjusting knob ①.

To return the seatback to the seating position, lift up each seatback and push it to the upright position until it is latched.



CAUTION:

When folding or returning the seatback(s) to the upright position, make sure that the seat path is clear before moving the seat to avoid injury to yourself and others.



WARNING:

- Never allow anyone to ride in the luggage area or on the rear seats when they are in the fold-down position. Use of these areas by passengers without proper restraints could result in serious injury in an accident

or sudden stop.

- Do not fold down the rear seats when occupants are in the rear seat area or any luggage is on the rear seats.
- Properly secure all luggage to help prevent it from sliding or shifting. Do not place luggage higher than the seatbacks.
- When returning the seatbacks to the upright position, be certain they are completely secured in the latched position. If they are not completely secured, passengers may be injured in an accident or sudden stop.
- Head restraints should be adjusted properly as they may provide significant protection against whiplash injury. Always replace and adjust them properly if they have been removed for any reason.

ARMREST

Front

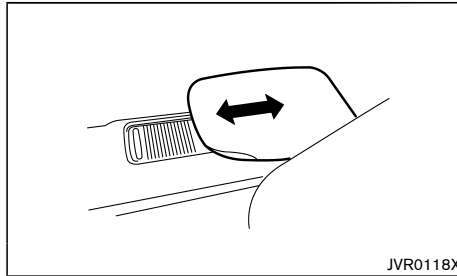

To use the front armrest, slide it forward.

Slide the armrest to the original position when using the front cup holders.

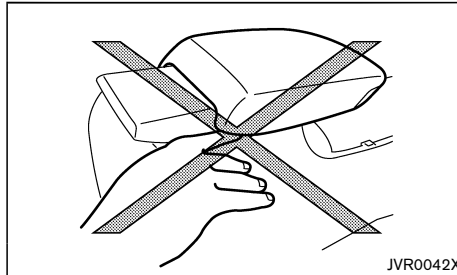

CAUTION:

When the front armrest is in the forward-most position, do not place your fingers on the bottom portion of the armrest to avoid possible injuries. Your fingers could be injured if the armrest slides to its original position.

Rear (if equipped)

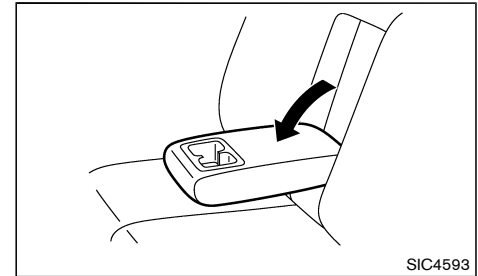

Pull the armrest forward until it is horizontal.

HEAD RESTRAINTS



WARNING:

Head restraints supplement the other vehicle safety systems. They may provide additional protection against injury in certain rear end collisions. Adjustable head restraints must be adjusted properly, as specified in this section. Check the adjustment after someone else uses the seat. Do not attach anything to the head restraint stalks or remove the head restraint. Do not use the seat if the head restraint has been removed. If the head restraint was removed, reinstall and properly adjust the head restraint before an occupant uses the seating position. Failure to follow these instructions can reduce the effectiveness of the head restraint. This may increase the risk of serious injury or death in a collision.

- Your vehicle is equipped with a head restraint that may be integrated, adjustable or non-adjustable.
- Adjustable head restraints have multiple notches along the stalk to lock them in a desired adjustment position.
- The non-adjustable head restraints have a single locking notch to secure them to the seat frame.
- Proper Adjustment:
 - For the adjustable type, align the head restraint so the center of your ear is approximately level with the center of the head restraint.
 - If your ear position is still higher than the recommended alignment, place the head restraint at the highest position.
- If the head restraint has been removed, ensure that it is reinstalled and locked in place before riding in that designated seating position.

ADJUSTABLE HEAD RESTRAINT

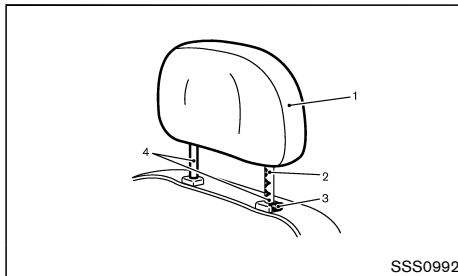

1. Removable head restraint
2. Multiple notches
3. Lock knob
4. Stalks

NON-ADJUSTABLE HEAD RESTRAINT

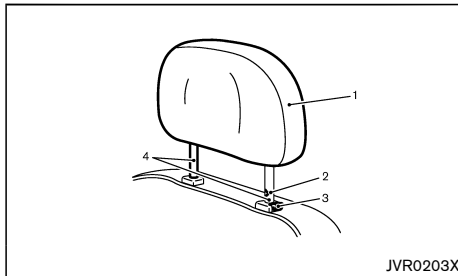

1. Removable head restraint
2. Single notch
3. Lock knob

4. Stalks

REMOVE

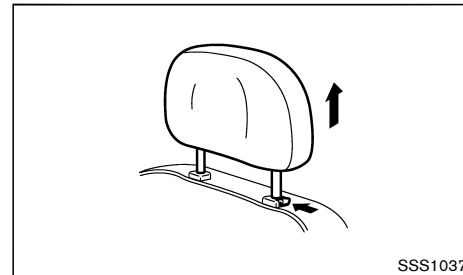

Use the following procedure to remove the head restraint.

1. Pull the head restraint up to the highest position.
2. Push and hold the lock knob.
3. Remove the head restraint from the seat.
4. Store the head restraint properly in a secure place so it is not loose in the vehicle.
5. Reinstall and properly adjust the head restraint before an occupant uses the seating position.

INSTALL

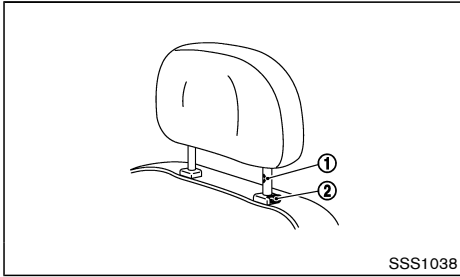

1. Align the head restraint stalks with the holes in the seat. Make sure that the head restraint is facing the correct direction. The stalk with the adjustment notch ① must be installed in the hole with the lock knob ②.
2. Push and hold the lock knob and push the head restraint down.
3. Properly adjust the head restraint before an occupant uses the seating position.

ADJUST

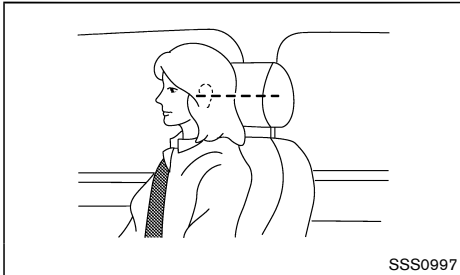

For adjustable head restraint

Adjust the head restraint so the center is level with the center of your ears. If your ear position is still higher than the recommended alignment, place the head restraint at the highest position.

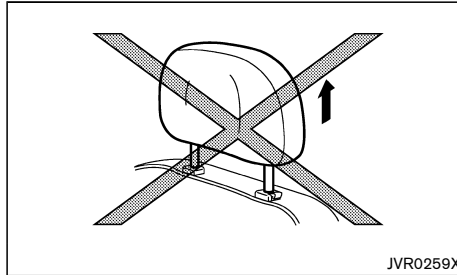

For non-adjustable head restraint

Make sure the head restraint is positioned from the stored position or any non-latch position so the lock knob is engaged in the notch before riding in that designated seating position.

Raise

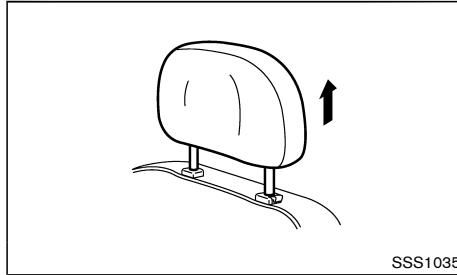

To raise the head restraint, pull it up.

Make sure the head restraint is positioned from the stored position or any non-latch position so the lock knob is engaged in the notch before riding in that designated seating position.

Lower

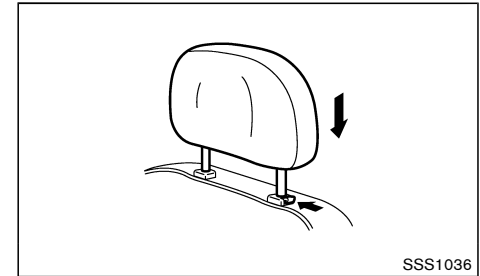

To lower, push and hold the lock knob and push the head restraint down.

Make sure the head restraint is positioned so the lock knob is engaged in the notch before riding in that designated seating position.

SEAT BELTS

PRECAUTIONS ON SEAT BELT USAGE

If you are wearing the seat belt properly adjusted and sitting upright and well back in the seat, chances of being injured or killed in an accident and/or the severity of injury may be greatly reduced. NISSAN strongly encourages you and all of your passengers to buckle up every time you drive, even if your seating position includes the supplemental air bag systems.

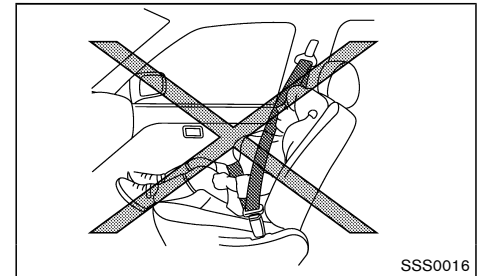
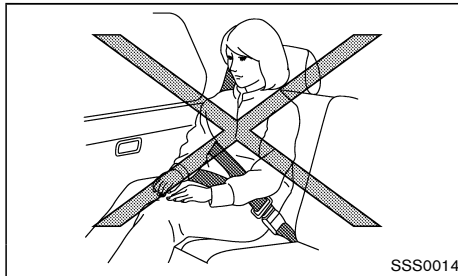
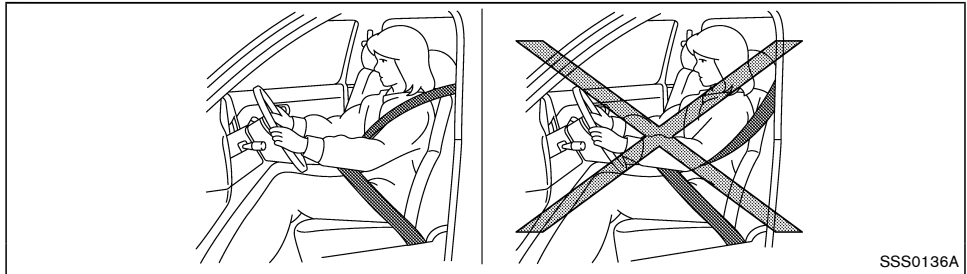
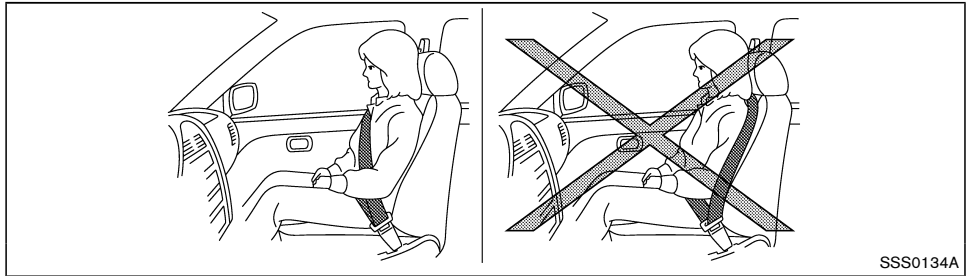



WARNING:

- Seatbelts are designed to bear upon the bony structure of the body, and should be worn low across the front of the pelvis or the pelvis, chest and shoulders, as applicable; wearing the lap section of the belt across the abdominal area must be avoided. Serious injury may occur if a seat belt is not worn properly.
- Position the lap belt as low and snug as possible around the hips, not the waist. A lap belt worn too high could increase the risk of internal injuries in an accident.
- Do not allow more than one person to use the same seat belt. Each belt assembly must only be used by one occupant; it is dangerous to put a belt around a child being carried on the occupant's lap.
- Never carry more people in the vehicle than there are seat belts.
- Never wear seat belts inside out. Belts should not be worn with straps twisted. Doing so may reduce their effectiveness.
- Seatbelts should be adjusted as firmly as possible, consistent with comfort, to provide the protection for which they have been designed. A slack belt will greatly reduce the protection afforded to the wearer.
- Every person who drives or rides in this vehicle should use a seat belt at all times. Children should be properly restrained in the rear seat and, if appropriate, in a child restraint system.

- Do not run the belt behind your back or under your arm. Always route the shoulder belt over your shoulder and across your chest. The belt should be away from your face and neck, but not falling off your shoulder. Serious injury may occur if a seat belt is not worn properly.
- No modifications or additions should be made by the user which will either prevent the seat belt adjusting devices from operating to remove slack, or prevent the seat belt assembly from being adjusted to remove slack.
- Care should be taken to avoid contamination of the webbing with polishes, oils and chemicals, and particularly battery acid. Cleaning may safely be carried out using mild soap and water. The belt should be replaced if webbing becomes frayed, contaminated or damaged.
- All seat belt assemblies including retractors and attaching hardware should be inspected after any collision by a NISSAN dealer. NISSAN recommends that all seat belt assemblies in use during a collision be replaced unless the collision was minor and the belts show no damage and continue to operate properly. Seat belt assemblies not in use during a collision should also be inspected and, when necessary, replaced if either damage or improper operation is noted.
- It is essential to replace the entire assembly after it has been worn in a severe impact even if damage to the assembly is not obvious.

- Once the pre-tensioner seat belt (if equipped) has activated, it cannot be reused. It must be replaced together with the retractor. Contact a NISSAN dealer.
- Removal and installation of the pre-tensioner seat belt system components (if equipped) should be done by a NISSAN dealer.

CHILD SAFETY



WARNING:

- Infants and children need special protection. The vehicle's seat belts may not fit them properly. The shoulder belt may come too close to the face or neck. The lap belt may not fit over their small hipbones. In an accident, an improperly fitted seat belt could cause serious or fatal injury.
- Always use an appropriate child restraint system.

Children need adults to help protect them. They need to be properly restrained. The proper restraint depends on the child's size.

Infants and small children

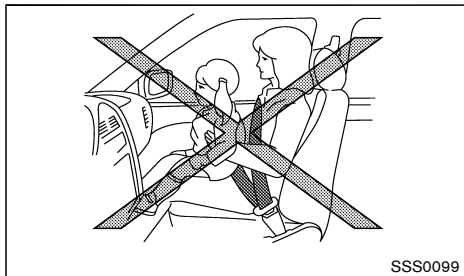

NISSAN recommends that infants and small children be seated in a child restraint system. You should choose a child restraint system that fits your vehicle and the child, and always follow the manufacturer's instructions for installation and use.

Large children



WARNING:

- **Never allow children to stand or kneel on any seats.**
- **Never allow children in the cargo areas while the vehicle is moving. A child could be seriously injured in an accident or sudden stop.**

Children who are too large for a child restraint system should be seated and restrained by the seat belts that are provided.

If the child's seating position has a shoulder belt that fits close to the face or neck, the use of a booster seat (commercially available) may help overcome this. The booster seat should raise the child so that the shoulder belt is properly positioned across the top, middle

portion of the shoulder and the lap belt is low on the hips. The booster seat should also fit the vehicle seat. Once the child has grown so that the shoulder belt is no longer on or near the face or neck of the child, use the shoulder belt without the booster seat. In addition, there are many types of child restraint systems available for larger children that should be used for maximum protection.

PREGNANT WOMEN

NISSAN recommends that pregnant women use seat belts. The seat belt should be worn snug, and always position the lap belt as low as possible around the hips, not the waist. Place the shoulder belt over your shoulder and across your chest. Never run the lap/shoulder belt over your abdominal area. Contact your doctor for specific recommendations.

INJURED PERSONS

NISSAN recommends that injured persons use seat belts. Contact your doctor for specific recommendations.

CENTER MARK ON SEAT BELTS

Selecting correct set of seat belts

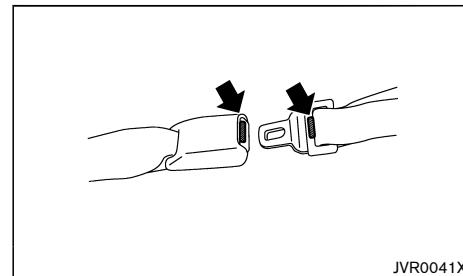

The center seat belt buckle and the tongue are identified by the CENTER mark. The center seat belt tongue can be fastened only into the center seat belt buckle.

THREE-POINT TYPE SEAT BELTS

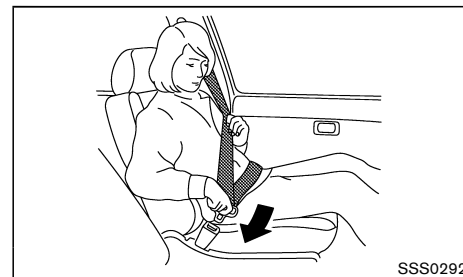

WARNING:

Every person who drives or rides in this vehicle should use a seat belt at all times.

Fastening seat belts



WARNING:

The seatback should not be in a reclined position any more than needed for comfort. Seat belts are most effective when the passenger sits well back and straight up in the seat.

1. Adjust the seat. (See “Seats” (P.1-2).)
2. Slowly pull the seat belt out of the retractor and insert the tongue into the buckle until you hear and feel the latch engage.
 - The retractor is designed to lock during a sudden stop or on impact. A slow pulling motion permits the seat belt to move, and allows you some freedom of movement in the seat.
 - If the seat belt cannot be pulled from its fully retracted position, firmly pull the belt and release it. Then smoothly pull the belt out of the retractor.

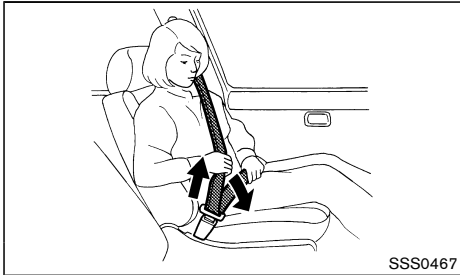

3. Position the lap belt portion low and snug on the hips as shown.

4. Pull the shoulder belt portion toward the retractor to take up extra slack. Be sure the shoulder belt is routed over your shoulder and is snug across your chest.

Shoulder belt height adjustment (front seats)

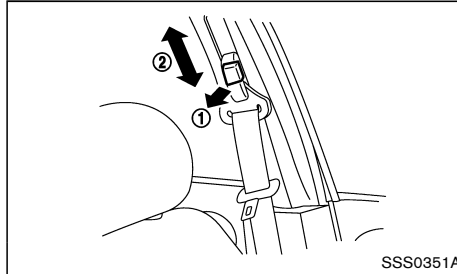

WARNING:

- The shoulder belt anchor height should be adjusted to the position best for you. Failure to do so may reduce the effectiveness of the entire restraint system and increase the chance or severity of injury in an accident.
- The shoulder belt should rest on the middle of the shoulder. It must not rest against the neck.
- Be sure that the seat belt is not twisted in any way.
- Be sure that the shoulder belt anchor is secured by trying to move the shoulder belt anchor up and down after adjustment.

The shoulder belt anchor height should be adjusted to the position best for you.

The belt should be away from your face and neck, but

not falling off your shoulder.

To adjust, pull the release button ① and move the shoulder belt anchor to the proper position ②, so that the belt passes over the center of the shoulder.

Release the button to lock the shoulder belt anchor into position.

Unfastening seat belts

Push the button on the buckle. The seat belt automatically retracts.

Seat belt hooks

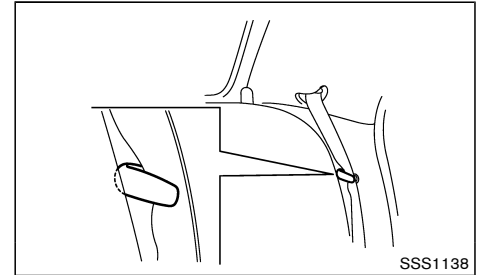

When the rear seat belts are not in use and when folding down the rear seats, hook the rear outer seat belts on the seat belt hooks.

Checking seat belt operation

Seat belt retractors are designed to lock seat belt movement:

- When the seat belt is pulled quickly from the retractor.
- When the vehicle slows down rapidly.

To increase your confidence in the seat belts, check the operation by grasping the shoulder belt and pulling forward quickly. The retractor should lock and restrict

further belt movement. If the retractor does not lock during this check, contact a NISSAN dealer immediately.

TWO-POINT TYPE SEAT BELTS (if equipped)

Fastening seat belts

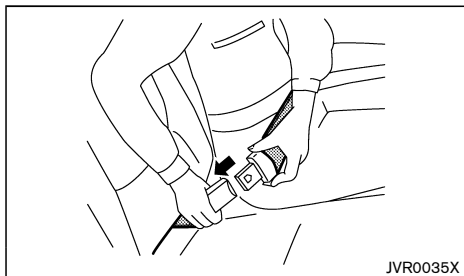

WARNING:

Seat belts are most effective when the passenger sits well back and straight up in the seat.

1. Insert the tongue into the buckle marked CENTER until you hear and feel the latch engage.

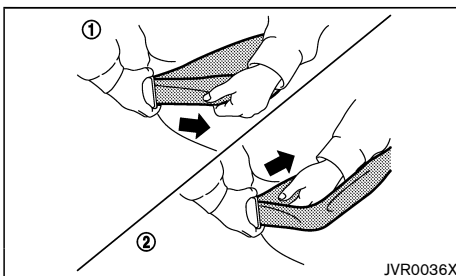

2. Adjust the seat belt length. To shorten, hold the tongue and pull the upper belt as illustrated ①. To lengthen, hold the tongue and pull the under belt as illustrated ②.

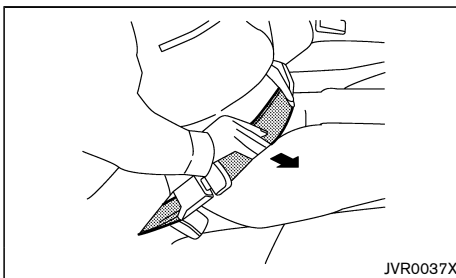

3. Position the lap belt portion low and snug on the hips as shown.

Unfastening seat belts

Push the button on the buckle.

SEAT BELT MAINTENANCE

Periodically check that the seat belt and all the metal components, such as buckles, tongues, retractors, flexible wires and anchors, work properly. If loose parts, deterioration, cuts or other damage on the seat belt webbing is found, the entire seat belt assembly should be replaced.

If dirt builds up in the shoulder belt guide of the seat belt anchors, the seat belts may retract slowly. Wipe the shoulder belt guide with a clean, dry cloth.

To clean the seat belt webbing, apply a mild soap solution or any solution recommended for cleaning upholstery or carpet. Then wipe with a cloth and allow the seat belts to dry in the shade. Do not allow the seat belts to retract until they are completely dry.

CHILD RESTRAINTS

PRECAUTIONS ON CHILD RESTRAINT USAGE

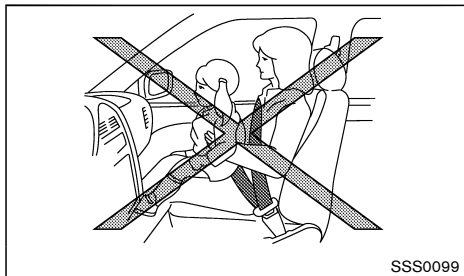

WARNING:

- Infants and small children should always be placed in an appropriate child restraint while riding in the vehicle. Failure to use a child restraint can result in serious injury or death.
- Infants and small children should never be carried on your lap. It is not possible for even the strongest adult to resist the forces of a severe accident. The child could be crushed between the adult and parts of the vehicle. Also, do not put the same seat belt around both your child and yourself.
- NISSAN recommends that the child restraints be installed in the rear seat. According to accident statistics, children are safer when properly restrained in the rear seat than in the front seat.
- Improper use or improper installation of a child restraint can increase the risk or severity of injury for both the child and other occupants of the vehicle and can lead to

serious injury or death in an accident.

- Follow all of the child restraint manufacturer's instructions for installation and use. When purchasing a child restraint, be sure to select one which will fit your child and vehicle. It may not be possible to properly install some types of child restraint in your vehicle.
- The direction of the child restraint, either front-facing or rear-facing, depends on the type of the child restraint and the size of the child. Refer to the child restraint manufacturer's instructions for details.
- Adjustable seatbacks should be positioned to fit the child restraint, but as upright as possible.
- After attaching a child restraint, test it before you place the child in it. Push it from side to side and tug it forward to make sure that it is held securely in place. The child restraint should not move more than 25 mm (1 in). If the restraint is not secure, tighten the belt as necessary, or install the restraint in another seat and test it again.
- When the child restraint is not in use, keep it secured with a seat belt to prevent it from being thrown around in case of a sudden stop or accident.
- Never install a rear-facing child restraint on the front passenger's seat when the front passenger's air bag is available. Supplemental front-impact air bags inflate with great force. A rear-facing child restraint could be struck by the supplemental front-impact air bags in an accident and could seriously injure or kill your child.

- If the seat belt in the position where a child restraint is installed requires a locking device and if it is not used, injuries could result from a child restraint tipping over during normal vehicle braking or cornering.



CAUTION:

Remember that a child restraint left in a closed vehicle can become very hot. Check the seating surface and buckles before placing your child in a child restraint.

NISSAN recommends that infants and small children be seated in a child restraint. You should choose a child restraint that fits your vehicle and always follow the manufacturer's instructions for installation and use. In addition, there are many types of child restraints available for larger children that should be used for maximum protection.

CHILD RESTRAINT ANCHORAGE (if equipped)

Your vehicle is designed to accommodate a child restraint system on the rear seat. When installing a child restraint system, carefully read and follow the instructions in this manual and those supplied with the child restraint system.



WARNING:

- Child restraint anchorages are designed to withstand only those loads imposed by correctly fitted child restraints. Under no circumstances are they to be used for adult seat belts, harnesses or for attaching other items or equipment to the vehicle. Doing so could damage the child restraint anchorages. The child restraint will not be

properly installed using the damaged anchorage, and a child could be seriously injured or killed in a collision.

- The child restraint top tether strap may be damaged by contact with the cargo cover or items in the luggage area. Remove the cargo cover from the vehicle or secure it and any luggage. Your child could be seriously injured or killed in a collision if the top tether strap is damaged.

Anchorage location

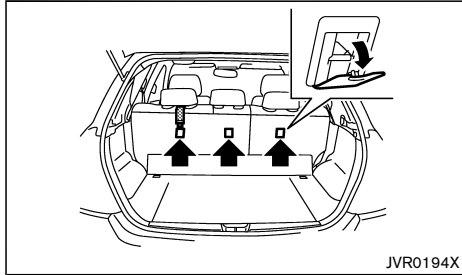

The anchor points are located on the back side of the rear seatbacks.

CHILD RESTRAINT INSTALLATION USING 3-POINT TYPE SEAT BELT (if equipped)

Installation on rear outer seats

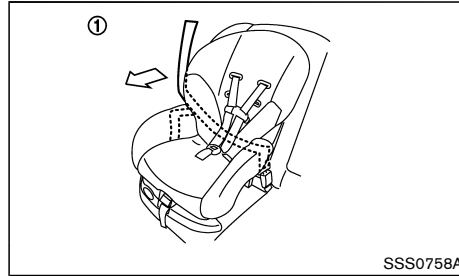

Step 1

Front-facing:

Be sure to follow the manufacturer's instructions for the proper use of your child restraint. Follow these steps to install a front-facing child restraint on the rear seats using 3-point type seat belt:

1. Position the child restraint on the seat ①.

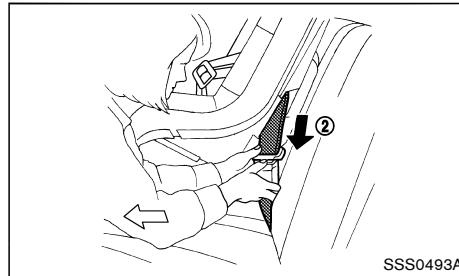

Step 2

2. Route the seat belt tongue through the child restraint and insert it into the buckle ② until you hear and feel the latch engage.
3. To prevent slack in the seat belt webbing, it is necessary to secure the seat belt in place with locking devices attached to the child restraint.

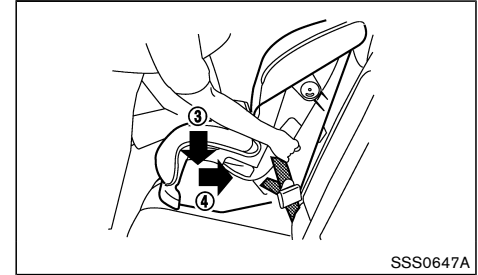

Step 4

4. Remove any additional slack from the seat belt; press downward ③ and rearward ④ firmly in the center of the child restraint with your knee to compress the vehicle seat cushion and seatback while pulling up on the seat belt.

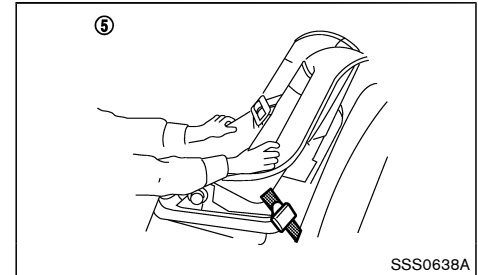

Step 5

5. Test the child restraint before you place the child in it (5). Push the child restraint from side to side and tug it forward to make sure that it is held securely in place.
6. Check to make sure that the child restraint is properly secured prior to each use. If the child restraint is loose, repeat steps 3 through 5.

Rear-facing:

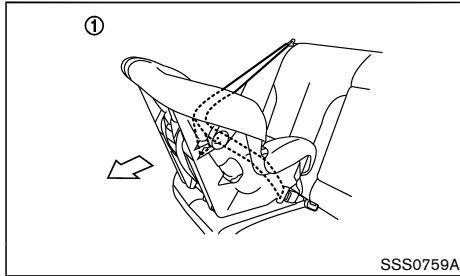

Step 1

Be sure to follow the manufacturer's instructions for the proper use of your child restraint. Follow these steps to install a rear-facing child restraint on the rear seats using 3-point type seat belt:

1. Position the child restraint on the seat (1).

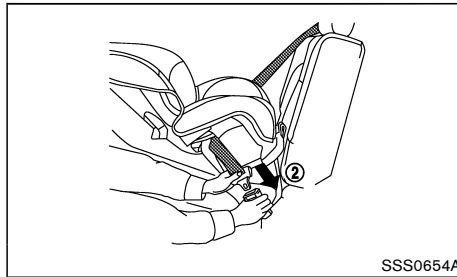

Step 2

2. Route the seat belt tongue through the child restraint and insert it into the buckle (2) until you hear and feel the latch engage.
3. To prevent slack in the seat belt webbing, it is necessary to secure the seat belt in place with locking devices attached to the child restraint.

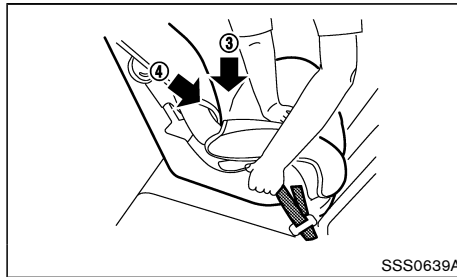

Step 4

4. Remove any additional slack from the seat belt; press downward (3) and rearward (4) firmly in the center of the child restraint with your hand to compress the vehicle seat cushion and seatback while pulling up on the seat belt.

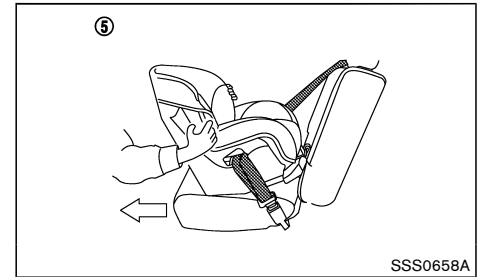

Step 5

5. Test the child restraint before you place the child in it (5). Push the child restraint from side to side and tug it forward to make sure that it is held securely in place.
6. Check to make sure that the child restraint is properly secured prior to each use. If the child restraint is loose, repeat steps 3 through 5.

Installation on front passenger's seat

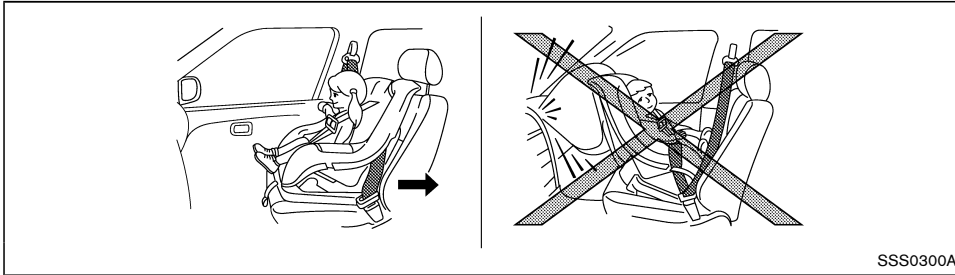

WARNING:

- **Never install a rear-facing child restraint on the front passenger's seat when the front passenger's air bag is available. Supplemental front-impact air bags inflate with great force. A rear-facing child restraint could be struck by the supplemental front-impact air bags in an accident and could seriously injure or kill your child.**
- **Never install a child restraint with a top tether strap on the front seat.**
- **NISSAN recommends that a child restraint be installed on the rear seat. However, if you must install a child restraint on the front passenger's seat, move the passenger's seat to the rearmost position.**
- **Child restraints for infants must be used in the rear-facing direction and therefore must not be used on the front passenger's seat when the front passenger's air bag is available.**

Front-facing:

Be sure to follow the manufacturer's instructions for the proper use of your child restraint. Follow these steps to install a front-facing child restraint on the front passenger's seat using 3-point type seat belt:

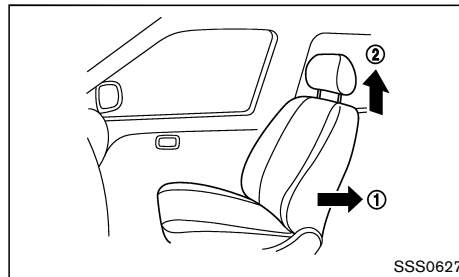

Steps 1 and 2

1. Move the seat to the rearmost position ①.
2. Adjust the head restraint to its highest position ②.
3. Position the child restraint in the seat.

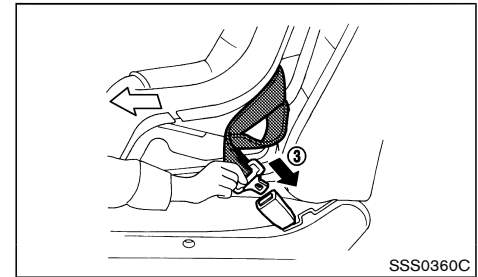

Step 4

4. Route the seat belt tongue through the child restraint and insert it into the buckle ③ until you hear and feel the latch engage.
5. To prevent slack in the seat belt webbing, it is necessary to secure the seat belt in place with locking devices attached to the child restraint.

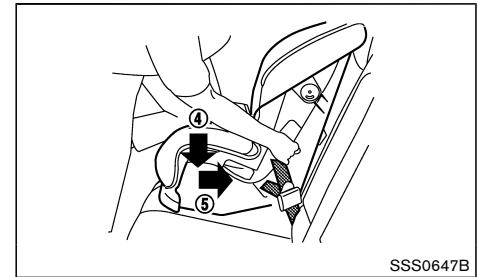

Step 6

6. Remove any additional slack from the seat belt; press downward ④ and rearward ⑤ firmly in the center of the child restraint with your knee to compress the vehicle seat cushion and seatback while pulling up on the seat belt.

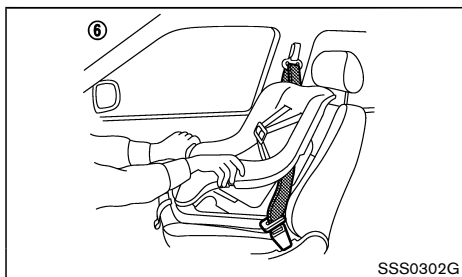

Step 7

7. Test the child restraint before you place the child in it ⑥. Push the child restraint from side to side and tug it forward to make sure that it is held securely in place.
8. Check to make sure that the child restraint is properly secured prior to each use. If the child restraint is loose, repeat steps 4 through 7.

CHILD RESTRAINT INSTALLATION USING 2-POINT TYPE SEAT BELT (if equipped)

Installation on rear center seat



WARNING:

The direction of the child restraint system depends on the type of the child restraint system and the size of the child.

Front-facing:

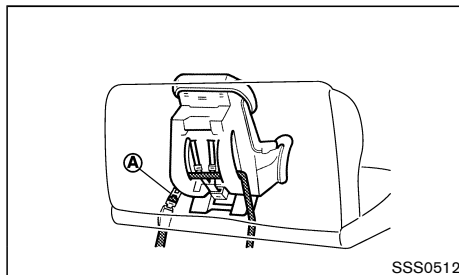

If you must install a front-facing child restraint system on the rear center seat, follow these steps:

1. Position the front-facing child restraint system on the rear center seat.
Always follow the child restraint system manufacturer's instructions for installation and use.
2. Route the seat belt tongue through the child restraint system and insert it into the buckle until you hear and feel the latch engage.

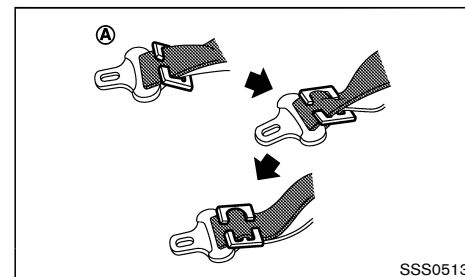

3. To prevent slack in the lap belt, it is necessary to secure the lap belt in place with a locking clip ①. Use the locking clip attached to the child restraint system, or one which is equivalent in dimensions and strength.
Be sure to follow the child restraint system manufacturer's instructions for belt routing.
4. Test the child restraint system before you place the child in it. Tilt it from side to side. Try to tug it forward and check if it is held securely in place.
5. Make sure that the child restraint system is properly secured prior to each use.

Rear-facing:

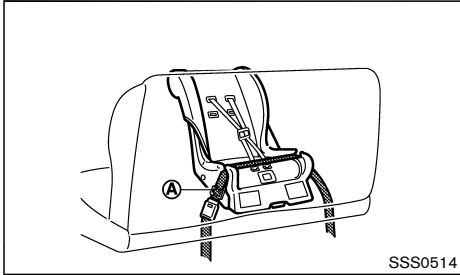

If you must install a rear-facing child restraint system on the rear center seat, follow these steps:

1. Position the rear-facing child restraint system on the rear center seat.

Always follow the child restraint system manufacturer's instructions for installation and use.

2. Route the seat belt tongue through the child restraint system and insert it into the buckle until you hear and feel the latch engage.

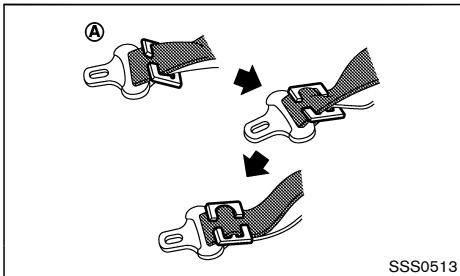

3. To prevent slack in the lap belt, it is necessary to secure the lap belt in place with a locking clip (A).

Use the locking clip attached to the child restraint system, or one which is equivalent in dimensions and strength.

Be sure to follow the child restraint system manufacturer's instructions for belt routing.

4. Test the child restraint system before you place the child in it. Tilt it from side to side. Try to tug it forward and check if it is held securely in place.
5. Make sure that the child restraint system is properly secured prior to each use.

SUPPLEMENTAL RESTRAINT SYSTEM (SRS)

PRECAUTIONS ON SUPPLEMENTAL RESTRAINT SYSTEM (SRS)

This Supplemental Restraint System (SRS) section contains important information concerning the driver's and passenger's supplemental front-impact air bags, supplemental side-impact air bags, supplemental curtain side-impact air bags and pre-tensioner seat belts.

Supplemental front-impact air bag system

This system can help cushion the impact force to the head and chest area of the driver and/or front passenger in certain frontal collisions. The supplemental front-impact air bag is designed to inflate on the front where the vehicle is impacted.

Supplemental side-impact air bag system (if equipped)

This system can help cushion the impact force to the chest and pelvis areas of the driver and front passenger in certain side-impact collisions. The supplemental side-impact air bag is designed to inflate on the side where the vehicle is impacted.

Supplemental curtain side-impact air bag system (if equipped)

This system can help cushion the impact force to the head of the driver and passengers in front and rear outboard seating positions in certain side-impact collisions. The supplemental curtain side-impact air bag is designed to inflate on the side where the vehicle is impacted.

The SRS is designed to **supplement** the accident protection provided by the driver's and passenger's seat belts and **is not** designed to **substitute** for them. The SRS can help save lives and reduce serious injuries. However, inflating air bags may cause abra-

sions or other injuries. Air bags do not provide protection to the lower body. Seat belts should always be correctly worn and the occupants should always be seated a suitable distance away from the steering wheel and instrument panel. (See "Seat belts" (P.1-7).) The air bags inflate quickly in order to help protect the occupants. The force of the air bags inflating can increase the risk of injury if the occupants are too close to, or are against, the air bag modules during inflation. The air bags will deflate quickly after deployment.

The SRS operates only when the ignition switch is in the "ON" position.

When the ignition switch is in the "ON" position, the SRS air bag warning light illuminates for about 7 seconds and then turns off. This indicates that the SRS air bag system is operational. (See "SRS air bag warning light" (P.1-21).)

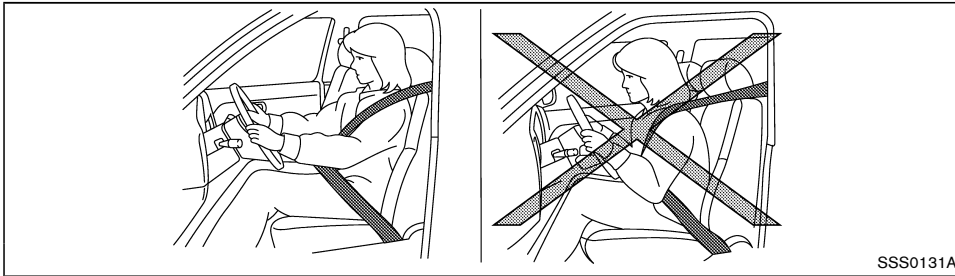

SSS0131A

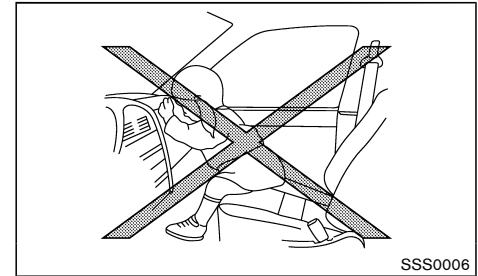

SSS0006

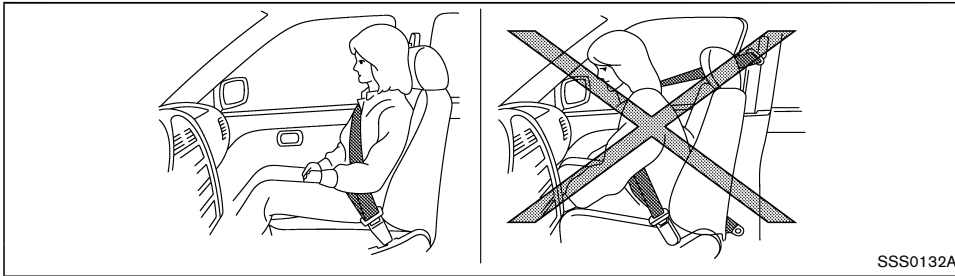

SSS0132A

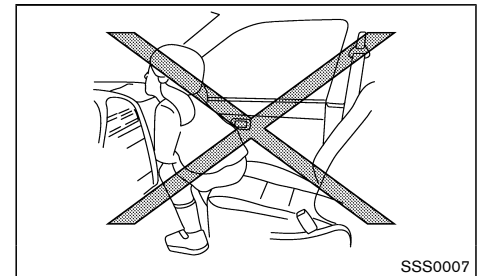

SSS0007

WARNING:

- The supplemental front-impact air bags ordinarily will not inflate in the event of a side impact, rear impact, rollover, or lower severity frontal collision. Always wear the seat belts to help reduce the risk or severity of injury in accidents.
- The seat belts and the supplemental front-impact air bags are most effective when you are sitting well back and upright in the seat. The front-impact air bags inflate with great force. If you and your passengers are unrestrained,

leaving the seat, leaning forward, sitting sideways, or out of position in any way, you and your passengers are at greater risk of injury or death in an accident. You and your passengers may also receive serious or fatal injuries from the supplemental front-impact air bag if you are up against it when it inflates. Always sit back against the seat-back and as far away as practical from the steering wheel or instrument panel. Always use the seat belts.

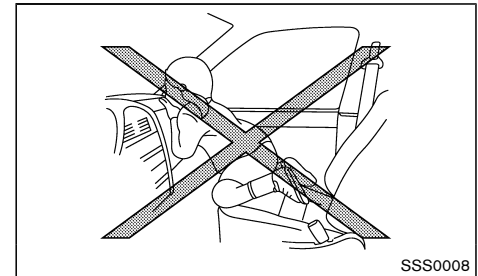

SSS0008

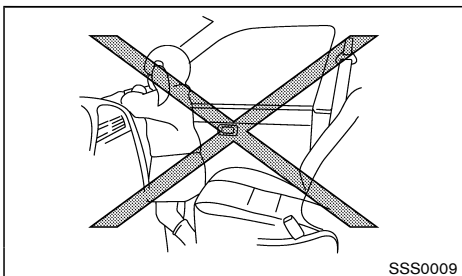

⚠ WARNING:

- Never let children ride unrestrained or extend their hands or face out of the window. Do not attempt to hold them in your lap or arms. Some examples of dangerous riding positions are shown in the illustrations.
- Children may be severely injured or killed if they are not properly restrained when the air bags inflate.
- Never install a rear-facing child restraint system on the front seat. An inflating supplemental front-impact air bag could seriously injure or kill your child. (See "Child restraints" (P.1-12).)

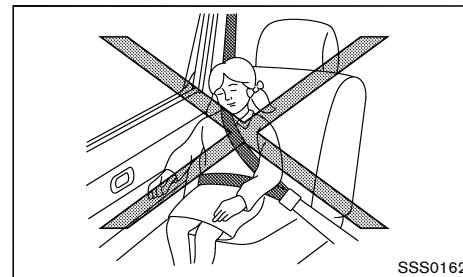
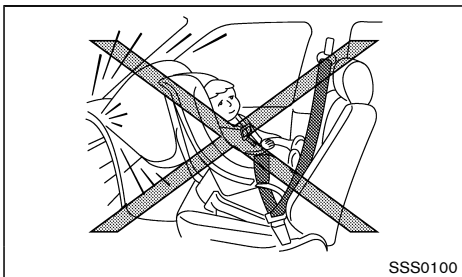
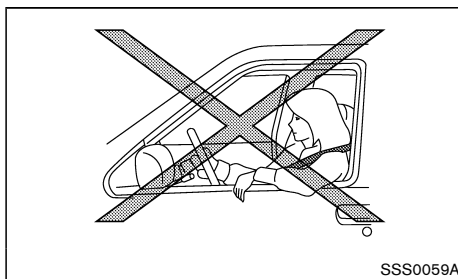
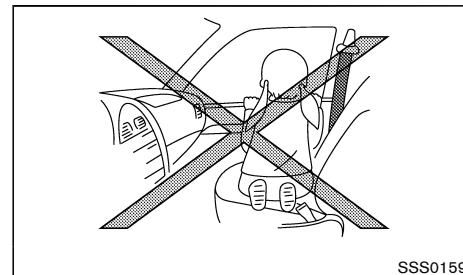
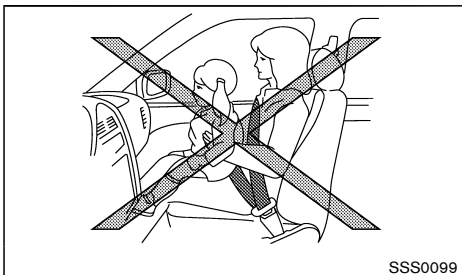
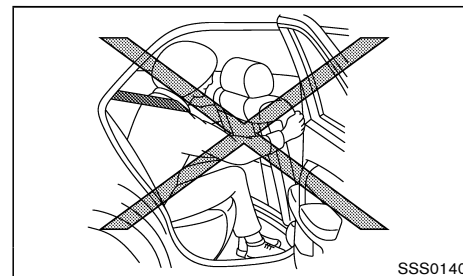



WARNING:

- The supplemental side-impact air bags and supplemental curtain side-impact air bags ordinarily will not inflate in the event of a front impact, rear impact, rollover, or lower severity side collision. Always wear the seat belts to help reduce the risk or severity of injury in accidents.
- The seat belts and the supplemental side-impact air bags and supplemental curtain side-impact air bags are most effective when you are sitting well back and upright in the seat. The supplemental side-impact air bags and supplemental curtain side-impact air bags inflate with great force. If you and your passengers are unrestrained, leaning forward, sitting sideways, or out of position in any way, you and your passengers are at greater risk of injury or death in an accident.
- Do not allow anyone to place their hands, legs, or face near the supplemental side-impact air bags and supplemental curtain side-impact air bags on the sides of the seatback of the front seats or near the side roof rails. Do not allow anyone sitting in the front seats or rear outboard seats to extend their hands out of the windows or lean against the doors. Some examples of dangerous riding positions are shown in the illustrations.
- When sitting in the rear seats, do not hold onto the seatback of the front seats. If the supplemental side-impact air bags and supplemental curtain side-impact air bags inflate, you may be seriously injured. Be especially careful with children, who should

always be properly restrained.

- Do not use seat covers on the front seatbacks. They may interfere with the supplemental side-impact air bag inflations.

Pre-tensioner seat belt system (if equipped)

The pre-tensioner system may activate with the supplemental air bag system in certain types of collisions. Working with the seat belt retractor and anchor, it helps tighten the seat belt the instant the vehicle becomes involved in certain types of collisions, helping to restrain front seat occupants. (See "Pre-tensioner seat belt system" (P.1-26).)

Air bag warning label

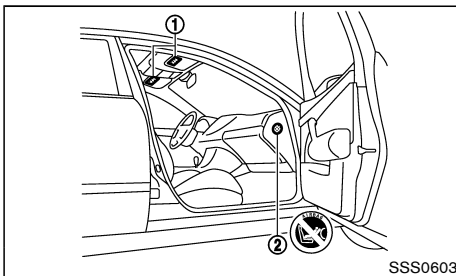

Warning labels about the supplemental air bag system are placed in the vehicle as shown in the illustration.

SRS air bag:

The warning label ① is located on the surface of the driver's and/or passenger's sun visor.

SRS front-impact passenger air bag :

The warning label ② (if equipped) is located on the side of the passenger's side instrument panel.

This label warns you not to fit a rear-facing child restraint system on the front passenger seat as such a restraint system used in this position could cause serious injury to the infant in case of air bag deployment during a collision.

In vehicles equipped with a front-impact passenger air bag system, use a rear-facing child restraint system only on the rear seats. "Extreme Hazard! Do not use a rearward facing child restraint on a seat protected by an airbag in front of it!"

When installing a child restraint system in your vehicle, always follow the child restraint system manufacturer's instructions for installation.

For additional information, see "Child restraints" (P.1-12).

SRS air bag warning light

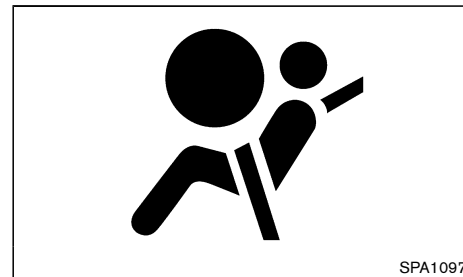

The SRS air bag warning light, displaying  in the instrument panel, monitors the circuits for the air bag systems, pre-tensioners and all related wiring.

When the ignition switch is in the "ON", the SRS air

bag warning light illuminates for about 7 seconds and then turns off. This indicates that the SRS air bag systems are operational.

If any of the following conditions occur, the air bags and/or pre-tensioner seat belt systems need servicing:

- The SRS air bag warning light remains on after approximately 7 seconds.
- The SRS air bag warning light flashes intermittently.
- The SRS air bag warning light does not illuminate at all.

Under these conditions, the air bags and/or pre-tensioner seat belt systems may not operate properly. They must be checked and repaired. Contact a NISSAN dealer immediately.

SUPPLEMENTAL AIR BAG SYSTEMS

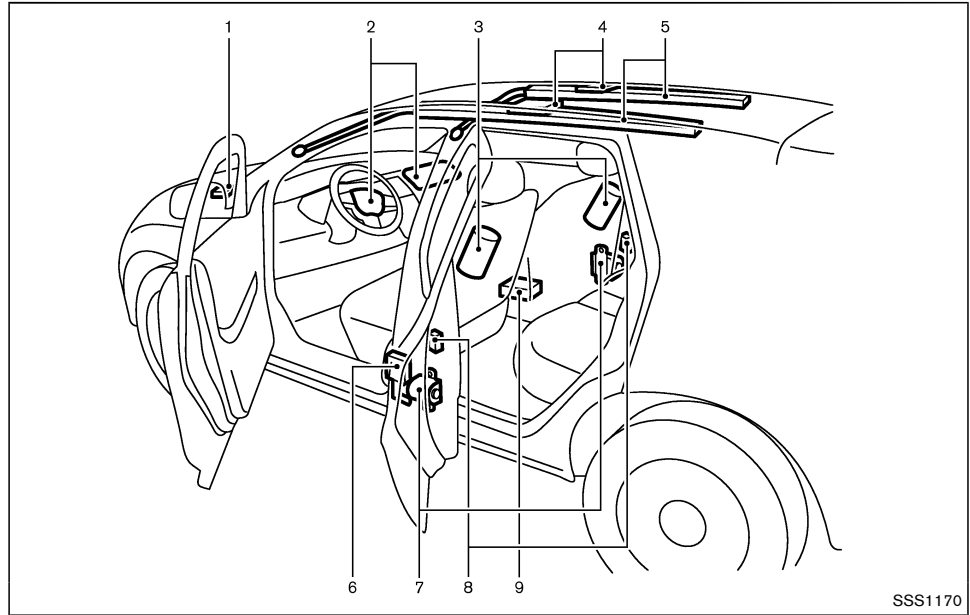

- | | |
|---|---|
| 1. Crash zone sensor | 6. Lap outer pre-tensioners (driver's side) (if equipped) |
| 2. Supplemental front-impact air bag modules | 7. Pre-tensioner seat belt retractors (if equipped) |
| 3. Supplemental side-impact air bag modules (if equipped) | 8. Satellite sensors (if equipped) |
| 4. Supplemental curtain side-impact air bag inflators (if equipped) | 9. Supplemental air bag diagnosis sensor unit |
| 5. Supplemental curtain side-impact air bags (if equipped) | |



WARNING:

- Do not place any objects on the steering wheel pad, on the instrument panel, and near the front door finishers and the front seats. Do not place any objects between any occupants and the steering wheel pad, on the instrument panel, and near the front door finishers and the front seats. Such objects may become dangerous projectiles and cause injury if a supplemental air bag inflates.
- Immediately after inflation, several supplemental air bag system components will be hot. Do not touch them: you may severely burn yourself.
- No unauthorized changes should be made to any components or wiring of the supplemental air bag systems. This is to prevent accidental inflation of the supplemental air bags or damage to the supplemental air bag systems.
- Do not make unauthorized changes to your vehicle's electrical system, suspension system, front end structure, and side panels. This could affect proper operation of the supplemental air bag systems.
- Tampering with the supplemental air bag systems may result in serious personal injury. Tampering includes changes to the steering wheel and the instrument panel by placing materials over the steering wheel pad and above, around or on the instrument panel or by installing additional trim materials around the supplemental air bag systems.

- Work around and on the supplemental air bag systems should be done by a NISSAN dealer. The SRS wiring should not be modified or disconnected. Unauthorized electrical test equipment and probing devices should not be used on the supplemental air bag systems.
- The SRS wiring harness connectors are yellow and/or orange for easy identification.

When the air bags inflate, a fairly loud noise may be heard, followed by the release of smoke. This smoke is not harmful and does not indicate a fire. Care should be taken not to inhale it, as it may cause irritation and choking. Those with a history of a breathing condition should get fresh air promptly.

Supplemental front-impact air bag system

The driver's supplemental front-impact air bag is located at the center of the steering wheel. The passenger's supplemental front-impact air bag is located at the instrument panel above the glove box.

The supplemental front-impact air bag system is designed to inflate in higher severity frontal collisions, although it may inflate if the forces in another type of collision are similar to those of a higher severity frontal impact. It may not inflate in certain frontal collisions. Vehicle damage (or lack of it) is not always an indication of proper supplemental front-impact air bag system operation.

Supplemental side-impact air bag system (if equipped)

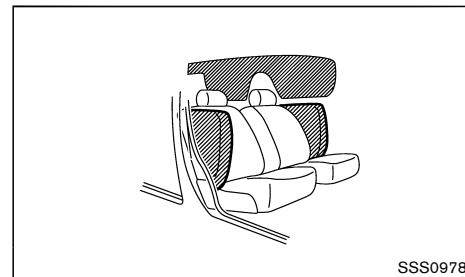

The supplemental side-impact air bag is located at the outside of the front seats' seatbacks.

The supplemental side-impact air bag system is designed to inflate in higher severity side collisions, although it may inflate if the forces in another type of collision are similar to those of a higher severity side impact. It may not inflate in certain side collisions. Vehicle damage (or lack of it) is not always an indication of proper supplemental side-impact air bag system operation.

Supplemental curtain side-impact air bag system (if equipped)

The supplemental curtain side-impact air bag is located at the roof rails.

The supplemental curtain side-impact air bag system is designed to inflate in higher severity side collisions, although it may inflate if the forces in another type of collision are similar to those of a higher severity side impact. It may not inflate in certain side collisions. Vehicle damage (or lack of it) is not always an indication of proper supplemental curtain side-impact air bag system operation.

SRS AIR BAG DEPLOYMENT CONDITIONS

The SRS air bags activate in the event of a front or side impact in which the vehicle occupants may be severely injured even if they are wearing the seat belts properly.

They may not activate when the crash energy is absorbed and/or distributed by the vehicle body. Vehicle damage (or lack of it) is not always an indication of proper SRS air bag system operation.

When the SRS air bag will deploy

Supplemental front-impact air bags:

The supplemental front-impact air bag system is designed to inflate in higher severity frontal collisions. Some examples are shown in the following illustrations.

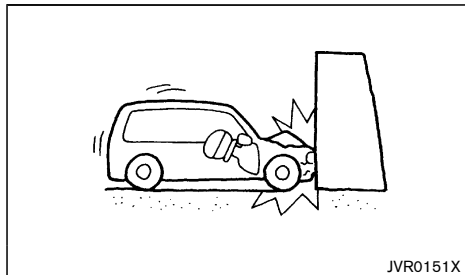

The supplemental front-impact air bag system will deploy in the event of an impact which exceeds a 25 km/h frontal collision with a solid wall that does not move or deform.

The supplemental front-impact air bag system may also deploy when the vehicle receives severe damage to the undercarriage.

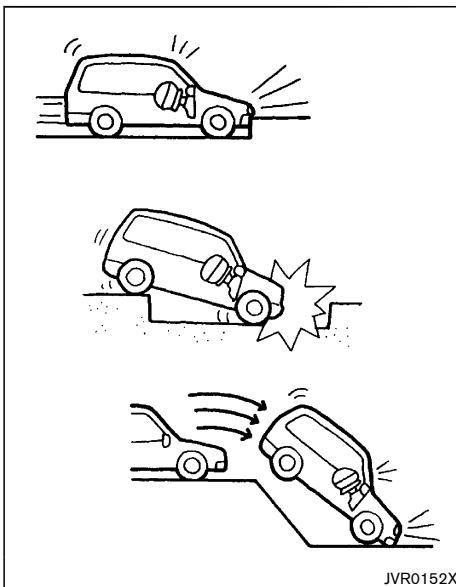

- Hitting a curb, pavement edge or hard surface at high speed
- Falling into a deep hole or ditch
- Landing hard on the ground after jumping

Supplemental side-impact and curtain side-impact air bags (if equipped):

The supplemental side-impact and curtain side-impact air bag systems are designed to inflate in higher severity side collisions. Some examples are shown in the following illustrations.

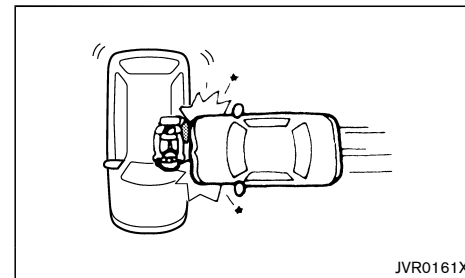

(supplemental side-impact air bag system)

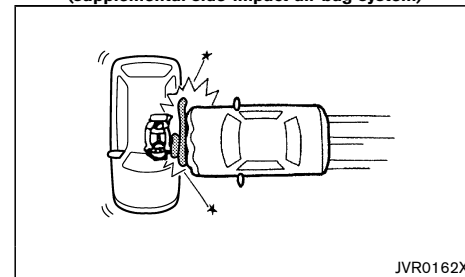

(supplemental curtain side-impact air bag system)

- The supplemental side-impact and curtain side-impact air bags will deploy in the event of a side impact with a normal passenger vehicle that exceeds at a speed of 25 km/h.

When the SRS air bag is unlikely to deploy

The SRS air bags may not deploy in cases where the impact is not forceful enough to inflate the SRS air bags.

For example, if the vehicle strikes an object, such as a parked vehicle or sign pole, which can move or deform on impact, the SRS air bags are unlikely to deploy.

Supplemental front-impact air bags:

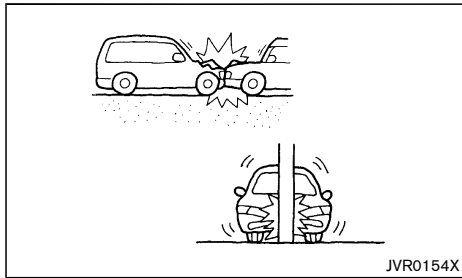

- Striking a vehicle of the same class that is parked
- Crashing into a solid utility pole

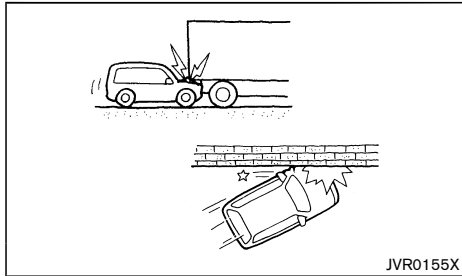

- Running under the tail gate of a truck
- A frontal offset impact to the guard rails

Supplemental side-impact and curtain side-impact air bags (if equipped):

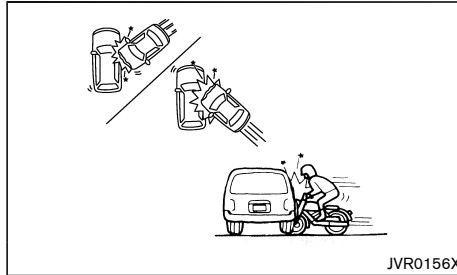

- A collision from the side at an angle
- A side impact with a two-wheeled vehicle

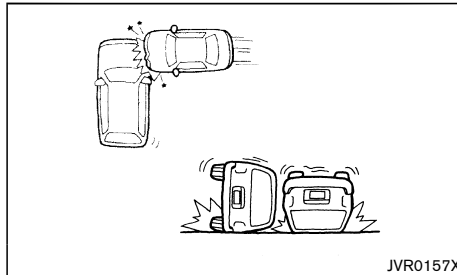

- A collision from the side impacting the vehicle engine room (luggage room)
- Vehicle rollover

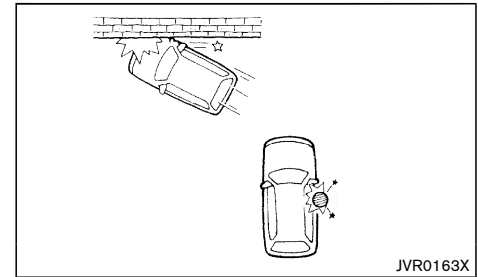

- A frontal offset impact to the guard rails
- A collision with a pole

When the SRS air bag will not deploy

Once the SRS air bag has inflated, the air bag module will not function again if your vehicle collides with another vehicle or an object.

Other examples where the SRS air bag will not deploy are shown in the following illustrations.

Supplemental front-impact air bags:

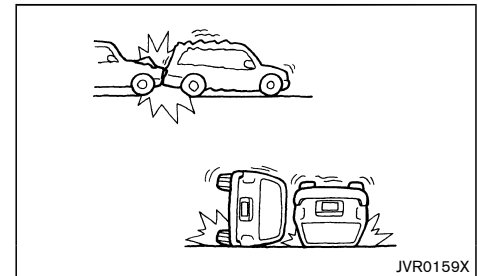

- A collision from the side or rear

- Vehicle rollover

Supplemental side-impact and curtain side-impact air bags (if equipped):

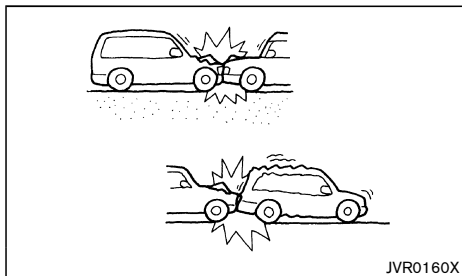

- A frontal collision with a parked or moving vehicle
- A rear collision

PRE-TENSIONER SEAT BELT SYSTEM (if equipped)



WARNING:

- **The pre-tensioner seat belt cannot be reused after activation. It must be replaced together with the retractor and buckle as a unit.**
- **If the vehicle becomes involved in a collision but the pre-tensioner is not activated, be sure to have the pre-tensioner system checked and, if necessary, replaced by a NISSAN dealer.**
- **No unauthorized changes should be made to any components or wiring of the pre-tensioner seat belt system. This is to prevent accidental activation of the pre-tensioner seat belt or damage to the pre-tensioner**

seat belt system.

- **Work around or on the pre-tensioner seat belt system should be done by a NISSAN dealer. The SRS wiring should not be modified or disconnected. Unauthorized electrical test equipment and probing devices should not be used on the pre-tensioner seat belt system.**
- **If you need to dispose of the pre-tensioner seat belt system, or scrap the vehicle, contact a NISSAN dealer. Correct pre-tensioner disposal procedures are set forth in the appropriate NISSAN Service Manual. Incorrect disposal procedures could cause personal injury.**

The pre-tensioner system may activate with the supplemental air bag system in certain types of collisions. Working with the seat belt retractor, it helps tighten the seat belt when the vehicle becomes involved in certain types of collisions, helping to restrain front seat occupants.

The pre-tensioner is encased with the front seat belt's retractor and anchor. These seat belts are used the same as conventional seat belts.

When the pre-tensioner seat belt activates, a fairly loud noise may be heard, followed by the release of smoke. This smoke is not harmful and does not indicate a fire. Care should be taken not to inhale it, as it may cause irritation and choking. Those with a history of a breathing condition should get fresh air promptly.

REPAIR AND REPLACEMENT PROCEDURE



WARNING:

- **Once the air bags have been inflated, the air bag modules will not function and must be replaced. The air bag modules must be replaced by a NISSAN dealer. The inflated air bag modules cannot be repaired.**
- **The air bag systems should be inspected by a NISSAN dealer if there is any damage to the front end portion of the vehicle.**
- **If you need to dispose of the SRS or scrap the vehicle, contact a NISSAN dealer. Correct disposal procedures are set forth in the appropriate NISSAN Service Manual. Incorrect disposal procedures could cause personal injury.**

The air bags and pre-tensioner seat belts are designed to activate on a one-time-only basis. As a reminder, unless the SRS air bag warning light is damaged, the SRS air bag warning light remains illuminated after inflation has occurred. The repair and replacement of the SRS should be done only by a NISSAN dealer.

When maintenance work is required on the vehicle, information about the air bags, pre-tensioner seat belts and related parts should be pointed out to the person performing the maintenance. The ignition switch should always be in the "LOCK" position when working under the hood or inside the vehicle.

2 Instruments and controls

Cockpit	2-2	Defogger switch	2-21
Left-Hand Drive (LHD) models	2-2	Horn	2-22
Right-Hand Drive (RHD) models	2-3	Windows	2-22
Instrument panel	2-4	Power windows	2-22
Left-Hand Drive (LHD) models	2-4	Sunroof (if equipped)	2-24
Right-Hand Drive (RHD) models	2-5	Automatic sunroof	2-24
Meters and gauges	2-6	Power outlet (if equipped)	2-25
Speedometer	2-6	Ashtray and cigarette lighter (if equipped)	2-25
Tachometer	2-6	Front	2-25
Engine coolant temperature gauge	2-7	Rear	2-26
Fuel gauge	2-7	Storages	2-26
Instrument brightness control	2-7	Glove box	2-26
Vehicle information display	2-8	Console box	2-26
Odometer	2-10	Cup holders	2-27
Warning/indicator lights and audible reminders	2-11	Sunglasses holder	2-27
Checking bulbs	2-12	Coat hook (if equipped)	2-28
Warning lights	2-12	Card holders (if equipped)	2-28
Indicator lights	2-14	Cargo cover	2-28
Audible reminders	2-16	Luggage hooks (if equipped)	2-29
Headlight and turn signal switch	2-17	Sun visors	2-29
Xenon headlights (if equipped)	2-17	Interior lights	2-29
Headlight switch	2-17	Room light	2-29
Headlight aiming control (if equipped)	2-18	Map lights	2-30
Turn signal switch	2-19	Vanity mirror lights (if equipped)	2-30
Fog light switch (if equipped)	2-19	Cargo room light	2-30
Front fog lights	2-19		
Wiper and washer switch	2-20		
Windshield wiper and washer switch	2-20		
Rear window wiper and washer switch	2-21		

COCKPIT

LEFT-HAND DRIVE (LHD) MODELS

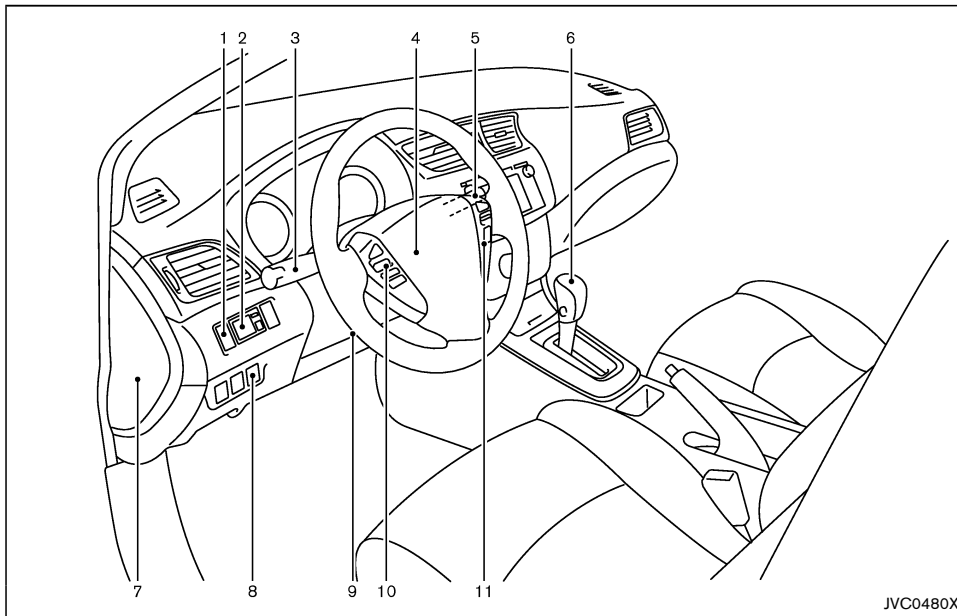

- | | |
|---|--|
| 1. Instrument brightness control switch | — Horn |
| 2. Outside rearview mirror control switch | — Driver's supplemental front-impact air bag |
| 3. Headlight, fog light* and turn signal switch | 5. Wiper and washer switch |
| — Headlight | 6. Shift lever |
| — Turn signal | — Continuously Variable Transmission (CVT) |
| — Fog light* | — Manual Transmission (MT) |
| 4. Steering wheel | 7. Fuse box cover |
| — Electric power steering system | |

8. Vehicle Dynamic Control (VDC) OFF switch*
9. Tilting/telescopic steering wheel lever
10. Steering-wheel-mounted controls (left side)
-  switch (odometer and trip computer)
 - Audio system*
 - Bluetooth® Hands-Free Phone System (without navigation system)*
 - Bluetooth® Hands-Free Phone System (with navigation system)**
11. Steering-wheel-mounted controls (right side)
- Cruise control switches*

*: if equipped

** : Refer to the separate NISSAN Connect Owner's Manual (if equipped).

RIGHT-HAND DRIVE (RHD) MODELS

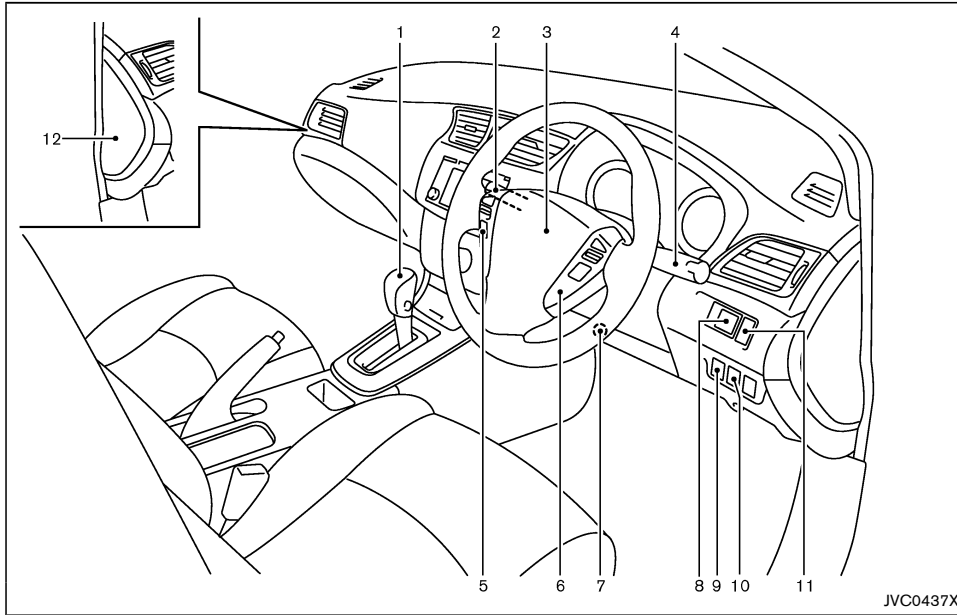

- | | |
|---|--|
| <ol style="list-style-type: none"> 1. Shift lever <ul style="list-style-type: none"> — Continuously Variable Transmission (CVT) — Manual Transmission (MT) 2. Wiper and washer switch 3. Steering wheel <ul style="list-style-type: none"> — Electric power steering system — Horn — Driver's supplemental front-impact air bag | <ol style="list-style-type: none"> 4. Headlight, fog light and turn signal switch <ul style="list-style-type: none"> — Headlight — Turn signal — Fog light* 5. Steering-wheel-mounted controls (left side) <ul style="list-style-type: none"> —  switch (odometer and trip computer) — Audio system* — Bluetooth® Hands-Free Phone System (with navigation system)* |
|---|--|

- Bluetooth® Hands-Free Phone System (with navigation system)**
 - 6. Steering-wheel-mounted controls (right side)
 - Cruise control switches*
 - 7. Tilting/telescopic steering wheel lever
 - 8. Outside rearview mirror control switch
 - 9. Vehicle Dynamic Control (VDC) OFF switch*
 - 10. Headlight aiming control switch*
 - 11. Instrument brightness control switch
 - 12. Fuse box cover
- *: if equipped
 **: Refer to the separate NISSAN Connect Owner's Manual (if equipped).

INSTRUMENT PANEL

LEFT-HAND DRIVE (LHD) MODELS

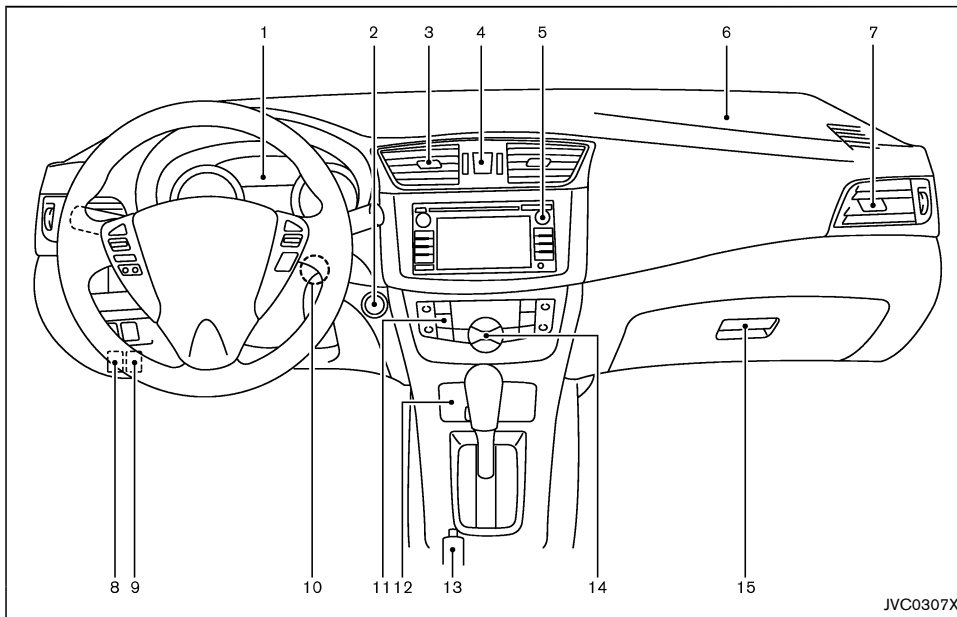

- | | |
|---|---|
| 1. Meters and gauges | 8. Fuel filler lid release handle |
| 2. Push-button ignition switch (models with Intelligent Key system) | 9. Hood release handle |
| 3. Center ventilator | 10. Ignition switch (models without Intelligent Key system) |
| 4. Hazard indicator flasher switch | 11. Defogger switch |
| 5. Audio system* or Navigation system** | 12. Ashtray and cigarette lighter |
| 6. Passenger's front-impact air bag | 13. Parking brake |
| 7. Side ventilator | 14. Heater and air conditioner control |

15. Glove box

*: if equipped

** : Refer to the separate NISSAN Connect Owner's Manual (if equipped).

RIGHT-HAND DRIVE (RHD) MODELS

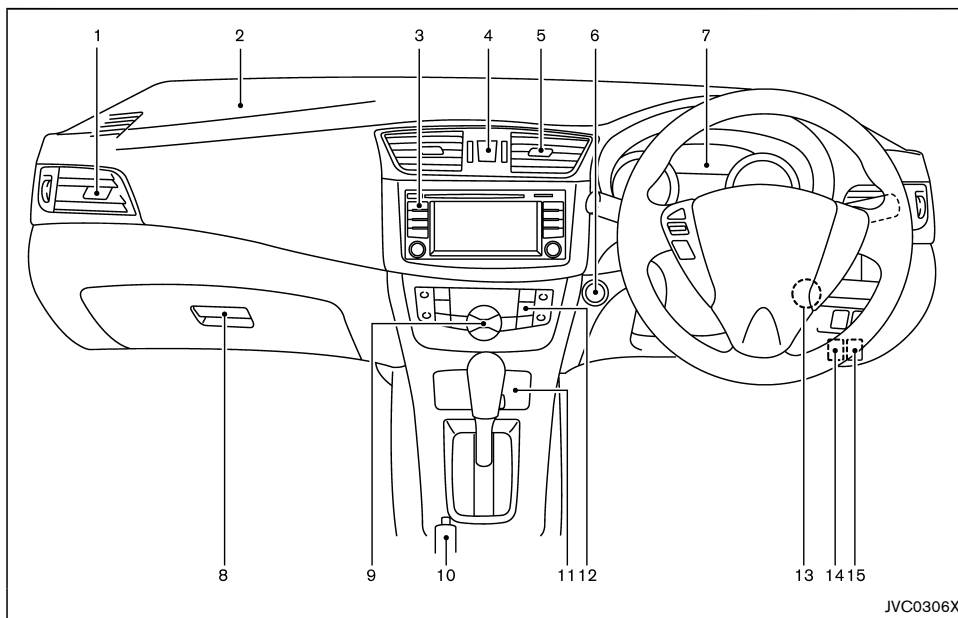

- | | |
|---|---|
| 1. Side ventilator | 8. Glove box |
| 2. Passenger's front-impact air bag | 9. Heater and air conditioner control |
| 3. Audio system* or Navigation system** | 10. Parking brake |
| 4. Hazard indicator flasher switch | 11. Power outlet* or Ashtray and cigarette lighter* |
| 5. Center ventilator | 12. Defogger switch |
| 6. Push-button ignition switch (models with Intelligent Key system) | 13. Ignition switch (models without Intelligent Key system) |
| 7. Meters and gauges | 14. Hood release handle |

15. Fuel filler lid release handle

*: if equipped

** : Refer to the separate NISSAN Connect Owner's Manual (if equipped).

METERS AND GAUGES

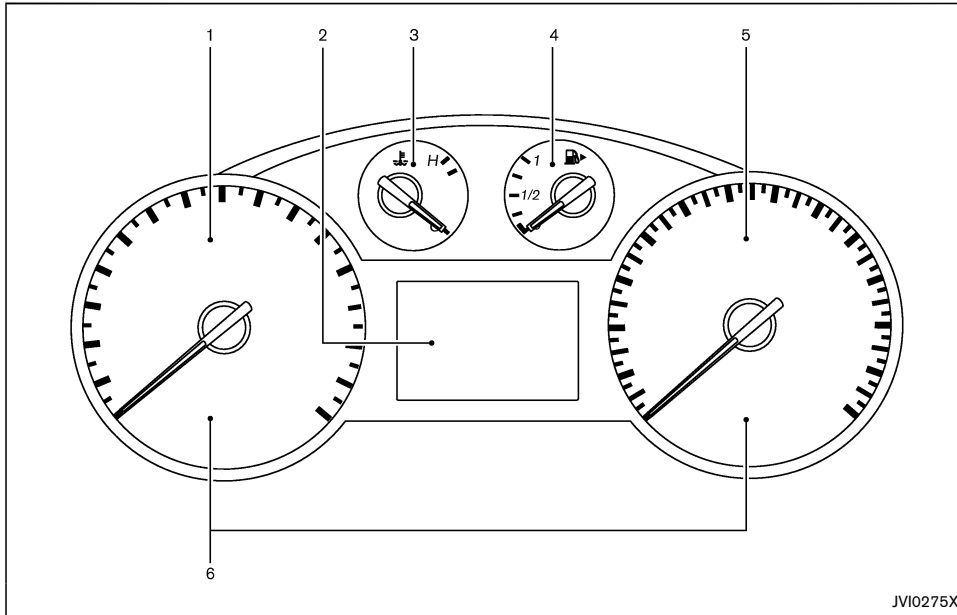

1. Tachometer
2. Vehicle information display
 - Odometer/twin trip odometer
 - Outside air temperature
 - Continuously Variable Transmission (CVT) position indicator*
 - Trip computer
3. Engine coolant temperature gauge
4. Fuel gauge

5. Speedometer
6. Warning/indicator lights
 - *: if equipped

The needle indicators may move slightly after the ignition switch is placed in the "OFF" or "LOCK" position. This is not a malfunction.

SPEEDOMETER

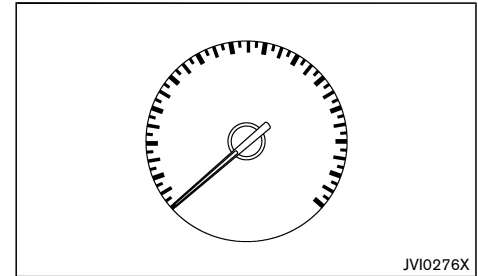

The speedometer indicates the vehicle speed.

TACHOMETER

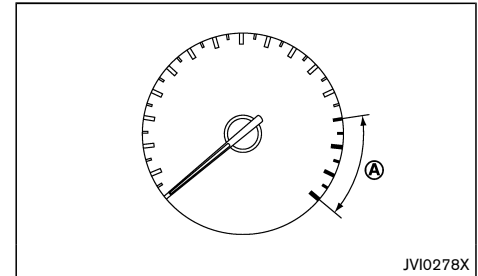

The tachometer indicates the engine speed in revolutions per minute (rpm). **Do not rev the engine into the red zone (A).**

ENGINE COOLANT TEMPERATURE GAUGE

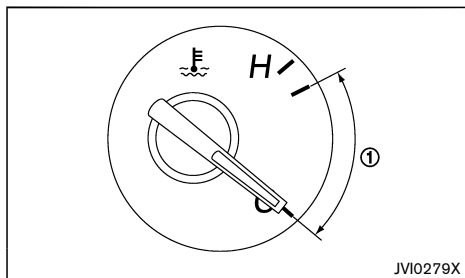

Type A

JVI0279X

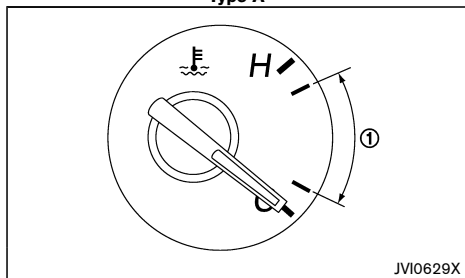

Type B

JVI0629X

The engine coolant temperature gauge indicates the engine coolant temperature.

The engine coolant temperature is normal when the gauge needle points within the zone ① shown in the illustration.

The engine coolant temperature will vary with the outside air temperature and driving conditions.



CAUTION:

- If the gauge indicates engine coolant temperature near the hot (H) end of the normal range, reduce vehicle speed to decrease temperature.
- If the gauge is over the normal range, stop the vehicle as soon as safely possible.
- If the engine is overheated, continued operation of the vehicle may seriously damage the engine. (See “If your vehicle overheats” (P.6-7) for immediate action required.)

FUEL GAUGE

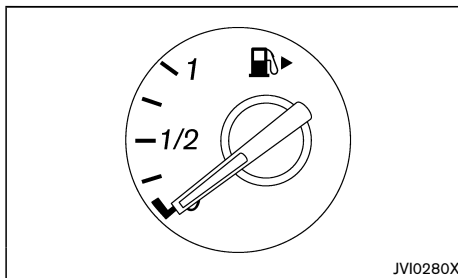

JVI0280X

The fuel gauge indicates the approximate fuel level in the tank when the ignition switch is in the “ON” position.

The gauge may move slightly during braking, turning, accelerating, or going up and down hills due to movement of fuel in the tank.

The low fuel warning light  illuminates when the fuel level in the tank is getting low. Refuel as soon as it is convenient, preferably before the gauge reads 0.

The arrow, , indicates that the fuel filler lid is

located on the right side of the vehicle.



CAUTION:

Refuel before the gauge reads 0 (empty).

There is a small reserve of fuel in the tank when the fuel gauge reads 0 (empty).

INSTRUMENT BRIGHTNESS CONTROL

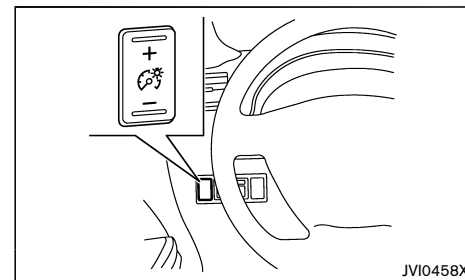

JVI0458X

The instrument brightness control operates when the ignition switch is in the “ON” position.

Push the + side of the switch to increase the brightness of the meter panel. Push the - side of the switch to decrease the brightness of the meter panel.

When the brightness level reaches the maximum or minimum, a beep will sound.

VEHICLE INFORMATION DISPLAY

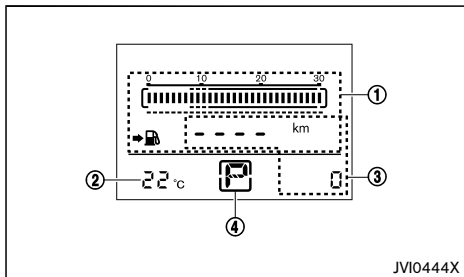

When the ignition switch is placed in the “ON” position, the vehicle information display shows the following information:

- ① Trip computer
—“Trip computer” (P.2-8)
- ② Outside air temperature
—“Outside air temperature” (P.2-8)
- ③ Odometer/Twin trip odometer
—“Odometer/Twin trip odometer” (P.2-10)
- ④ Continuously Variable Transmission (CVT) position indicator (if equipped)
—“Continuously Variable Transmission (CVT) position indicator” (P.2-8)

Outside air temperature

The outside air temperature is displayed in °C.

When the outside air temperature becomes 3°C (37°F) or lower, the outside air temperature display blinks to give a warning.

The display will stop blinking after 1 minute or when the outside air temperature becomes 4°C (39°F) or above.

Continuously Variable Transmission (CVT) position indicator (if equipped)

The Continuously Variable Transmission (CVT) position indicator indicates the shift lever position when the ignition switch is in the “ON” position.

Trip computer

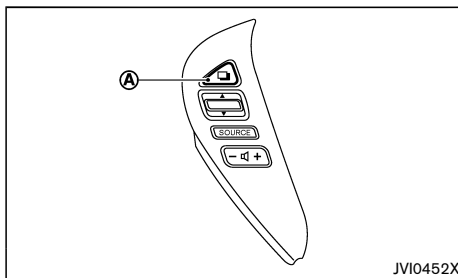

The switch for the trip computer is located on the left side of the steering wheel.

When the ignition switch is placed in the “ON” position, modes of the trip computer can be selected by pushing the switch (A).

Each time the switch (A) is pushed, the display will change as follows:

Eco Pedal guide (if equipped) → Average fuel consumption (graph and digit) → Average fuel consumption (digit) → Average vehicle speed → Distance to empty (dte) → (TRIP A → TRIP B) → Eco Pedal guide (if equipped)

Eco Pedal guide (if equipped):

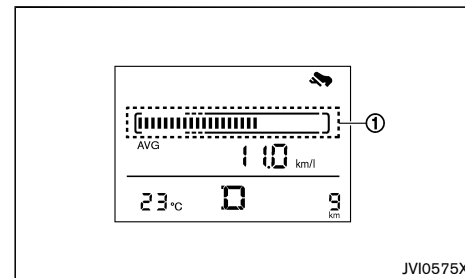

Type A

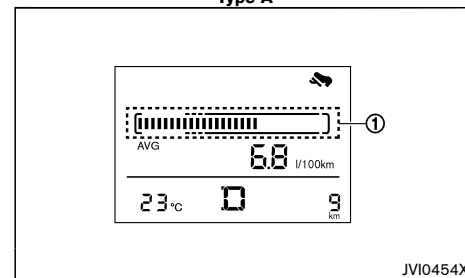

Type B

Use the Eco Pedal guide for improving fuel economy.

When the Eco Pedal guide bar is in the green range, it indicates that the vehicle is driven within range of economy drive.

If the Eco Pedal guide bar is out of green range, it indicates that the accelerator pedal is depressed over the range of economy drive.

The Eco Pedal guide bar is not displayed when the cruise control system (if equipped) is operating.

Average fuel consumption (km/l or l/100km):

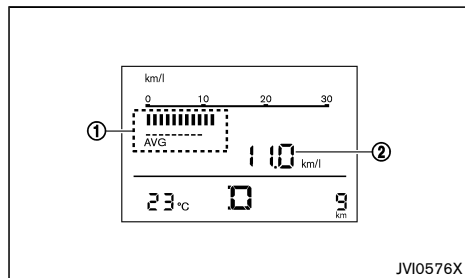

Type A

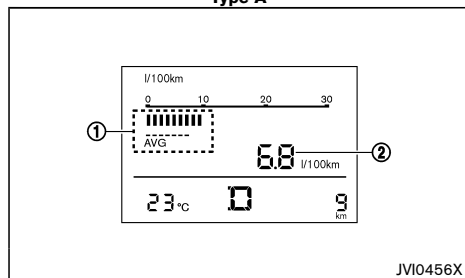

Type B

The average fuel consumption mode provides the current and average fuel consumption graphically (1). The location (2) also shows the average consumption.

The average fuel consumption mode shows the average fuel consumption since the last reset. Resetting is done by pushing the switch (A) for longer than 1 second.

The display is updated every 30 seconds. At about the first 500 m (1/3 miles) after a reset, the display shows "----" and the digit (2) is not displayed.

Average vehicle speed (km/h):

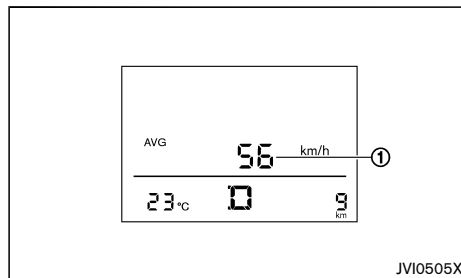

The average vehicle speed mode shows the average vehicle speed (1) since the last reset. Resetting is done by pushing the switch (A) for longer than 1 second. The display is updated every 30 seconds. The first 30 seconds after a reset, the display shows "----".

Distance to empty (dte — km):

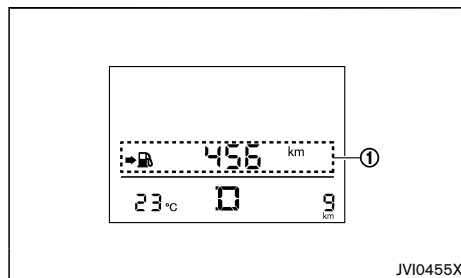

The distance to empty (dte) mode provides you with an estimation of the distance (1) that can be driven before refueling. The dte is constantly being calculated, based on the amount of fuel in the fuel tank and the actual fuel consumption.

The display is updated every 30 seconds.

The dte mode includes a low range warning feature: when the fuel level is low, the dte mode is automatically selected and the digits blink in order to draw the driver's attention. Push the switch (A) to return to the mode that was selected before the warning occurred.

When the fuel level drops even lower, the dte display will change to "----".

- If the amount of fuel added is small, the display just before the ignition switch is turned off may continue to be displayed.
- When driving uphill or rounding curves, the fuel in the tank shifts, which may momentarily change the display.

Resetting displays:

Push the switch (A) for longer than 3 seconds. The display of average fuel consumption, average vehicle speed and trip odometer (TRIP B only) will be reset at the same time.

ODOMETER

Odometer/Twin trip odometer

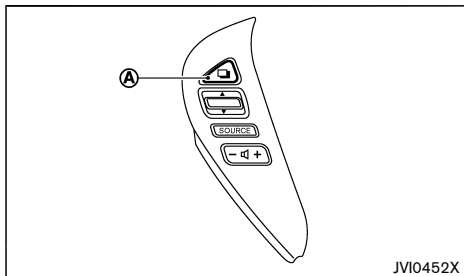
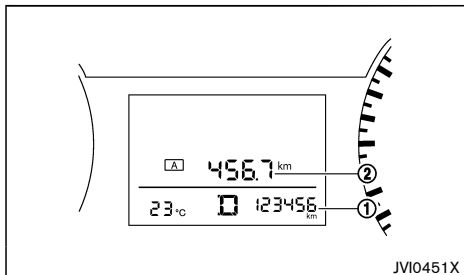

The odometer/twin trip odometer is displayed on the vehicle information display when the ignition switch is in the "ON" position.

The odometer ① displays the total distance the vehicle has been driven.

The twin trip odometer ② displays the distance of individual trips.

Changing trip odometer display:

Push the  switch (A) on the left side of steering wheel to change the display as follows:

























TRIP A → TRIP B → Trip computer mode → TRIP A

For trip computer information, see "Trip computer" (P.2-8).





Resetting trip odometer:







Push the  switch (A) for approximately 1 second to reset the trip odometer to zero.

WARNING/INDICATOR LIGHTS AND AUDIBLE REMINDERS

	Anti-lock Braking System (ABS) warning light*		P position selecting warning light*		Malfunction Indicator Light (MIL)
	Brake warning light		Seat belt warning light		Security indicator light*
	Charge warning light		Speed [120 km/h (75 MPH)] warning light*		Small light indicator light
	Door open warning light		Supplemental Restraint System (SRS) air bag warning light		Sport mode indicator light*
	Electric power steering warning light		Vehicle Dynamic Control (VDC) warning light*		Trailer direction indicator light*
	Engine oil pressure warning light		Cruise indicator light*		Turn signals/hazard indicator lights
	Intelligent Key system warning light*		Engine start operation indicator light*		Vehicle Dynamic Control (VDC) off indicator light*
	Low fuel warning light		Front fog lights indicator light*	*: if equipped	
	Low washer fluid warning light*		High beam indicator light		

CHECKING BULBS

With all doors closed, apply the parking brake, fasten the seat belts and place the ignition switch in the "ON" position without starting the engine. If equipped, the following lights will illuminate: , , , , **PS**.

If equipped, the following lights will illuminate briefly and then turn off: , , , , , , **SPORT**.

If any lights fail to illuminate, it may indicate a burned-out bulb or an open circuit in the electrical system. Have the system checked, and if necessary repaired, by a NISSAN dealer promptly.

WARNING LIGHTS

Anti-lock Braking System (ABS) warning light (if equipped)

When the ignition switch is in the "ON" position, the Anti-lock Braking System (ABS) warning light illuminates and then turns off. This indicates the ABS is operational.

If the ABS warning light illuminates while the engine is running, or while driving, it may indicate the ABS is not functioning properly. Have the system checked by a NISSAN dealer promptly.

If an ABS malfunction occurs, the anti-lock function is turned off. The brake system then operates normally, but without anti-lock assistance. (See "Brake system" (P.5-22).)

Brake warning light

WARNING:

- **If the brake fluid level is below the minimum mark on the brake fluid reservoir, do not drive the vehicle until the brake system has been checked by a NISSAN dealer.**
- **Even if you judge it to be safe, have your vehicle towed because driving it could be dangerous.**
- **Depressing the brake pedal without the engine running and/or with a low brake fluid level could increase the stopping distance and require greater pedal travel distance and effort.**

The brake warning light indicates the parking brake system operation, a low brake fluid level of the brake system and an Anti-lock Braking System (ABS) malfunction.

Parking brake warning indicator:

When the ignition switch is placed in the "ON" position, the brake warning light illuminates. When the engine is started and the parking brake is released, the brake warning light turns off.

If the parking brake is not fully released, the brake warning light remains on. Be sure that the brake warning light has turned off before driving. (See "Parking brake" (P.3-19).)

Low brake fluid warning indicator:

If the brake warning light illuminates while the engine is running, or while driving, and the parking brake is released, it may indicate the brake fluid level is low.

When the brake warning light illuminates while driving,

stop the vehicle safely as soon as possible. Stop the engine and check the brake fluid level. If the brake fluid level is at the minimum mark, add brake fluid as necessary. (See "Brake fluid" (P.8-13).)

If the brake fluid level is sufficient, have the brake system checked by a NISSAN dealer promptly.

Anti-lock Braking System (ABS) warning indicator (if equipped):

When the parking brake is released and the brake fluid level is sufficient, if both the brake warning light and the Anti-lock Braking System (ABS) warning light illuminate, it may indicate the ABS is not functioning properly. Have the brake system checked, and if necessary repaired, by a NISSAN dealer promptly. (See "Anti-lock Braking System (ABS) warning light" (P.2-12).)

Charge warning light

When the ignition switch is in the "ON" position, the charge warning light illuminates. After starting the engine, the charge warning light turns off. This indicates the charging system is operational.

If the charge warning light illuminates while the engine is running, or while driving, it may indicate the charging system is not functioning properly and may need servicing.

When the charge warning light illuminates while driving, stop the vehicle safely as soon as possible. Stop the engine and check the alternator belt. If the alternator belt is loose, broken or missing, the charging system needs repair. (See "Drive belt" (P.8-11).)

If the alternator belt appears to be functioning correctly but the charge warning light remains illuminated, have the charging system checked by a NISSAN dealer promptly.



CAUTION:

Do not continue driving if the alternator belt is loose, broken or missing.



Door open warning light

When the ignition switch is in the “ON” position, the door open warning light illuminates if any of the doors are open or not closed securely.



Electric power steering warning light

When the ignition switch is in the “ON” position, the electric power steering warning light illuminates. After starting the engine, the electric power steering warning light turns off. This indicates the electric power steering system is operational.

If the electric power steering warning light illuminates while the engine is running, it may indicate the electric power steering system is not functioning properly and may need servicing. Have the electric power steering system checked by a NISSAN dealer.

When the electric power steering warning light illuminates with the engine running, the power assist to the steering will cease operation but you will still have control of the vehicle. At this time, greater steering efforts are required to operate the steering wheel, especially in sharp turns and at low speeds.

(See “Electric power steering system” (P.5-22).)



Engine oil pressure warning light

When the ignition switch is in the “ON” position, the engine oil pressure warning light illuminates. After starting the engine, the engine oil pressure warning light turns off. This indicates that the oil pressure sensors in the engine are operational.

If the engine oil pressure warning light illuminates while the engine is running, it may indicate that the engine oil pressure is low.

Stop the vehicle safely as soon as possible. Stop the engine immediately and call a NISSAN dealer.



CAUTION:

- **Running the engine with the engine oil pressure warning light illuminated could cause serious damage to the engine.**
- **The engine oil pressure warning light is not designed to indicate a low oil level. The oil level should be checked using the dipstick. (See “Engine oil” (P.8-9).)**



Intelligent Key system warning light (if equipped)

After the ignition switch is placed in the “ON” position, this light comes on for about 2 seconds and then turns off.

This light illuminates or blinks as follows:

- The light blinks in yellow when the door is closed with the Intelligent Key left outside the vehicle and the ignition switch in the “ACC” or “ON” position. Make sure that the Intelligent Key is inside the vehicle.

- The light blinks in green when the Intelligent Key battery is running out of power. Replace the battery with a new one. (See “Battery” (P.8-18).)
- The light illuminates in yellow when it warns of a malfunction with the electrical steering lock system or the Intelligent Key system.

If the warning light illuminates in yellow while the engine is stopped, it may be impossible to free the steering lock or to start the engine. If the light comes on while the engine is running, you can drive the vehicle. However in these cases, contact a NISSAN dealer for repair as soon as possible.



Low fuel warning light

The low fuel warning light illuminates when the fuel level in the tank is getting low. Refuel as soon as it is convenient, preferably before the fuel gauge reaches 0 (empty).

There will be a small reserve of fuel remaining in the tank when the fuel gauge reaches 0 (empty).



Low washer fluid warning light (if equipped)

This light comes on when the washer tank fluid is at a low level. Add washer fluid as necessary. (See “Window washer fluid” (P.8-17).)



P position selecting warning light (if equipped)

The warning light blinks in red when the ignition switch is pushed to stop the engine with the shift lever in any position except the “P” (Park) position.

If this warning appears, move the shift lever to the “P” (Park) position or push the ignition switch to the “ON”

position.

An inside warning chime will also sound.

See “Intelligent Key system” (P.3-7).



Seat belt warning light and chime

Type A:

When the ignition switch is in the “ON” position, the seat belt warning light illuminates. The light will continue to illuminate until the front seat belts are fastened. (See “Seat belts” (P.1-7).)

When the vehicle speed exceeds 15 km/h (10 MPH), the light will blink and the chime will sound unless the front seat belts are securely fastened. The chime will continue to sound for about 90 seconds until the seat belt is fastened.

Type B:

When the ignition switch is in the “ON” position, the seat belt warning light illuminates. The light will continue to illuminate until the driver’s seat belt is fastened. (See “Seat belts” (P.1-7).)



Speed [120 km/h (75 MPH)] warning light (if equipped)

This light blinks when the vehicle speed goes over approximately 120 km/h (75 MPH). Be sure to observe the speed limit in the area where you are driving.



Supplemental Restraint System (SRS) air bag warning light

When the ignition switch is in the “ON” position, the Supplemental Restraint System (SRS) air bag warning light illuminates for about 7 seconds and then turns off. This indicates the SRS air bag system is operational.

If any of the following conditions occur, the SRS air bag system and/or pre-tensioner seat belt need servicing. Have the system checked, and if necessary repaired, by a NISSAN dealer promptly.

- The SRS air bag warning light remains illuminated after about 7 seconds.
- The SRS air bag warning light flashes intermittently.
- The SRS air bag warning light does not come on at all.

Unless checked and repaired, the SRS air bag system and/or pre-tensioner seat belt may not function properly. (See “Supplemental Restraint System (SRS)” (P.1-18).)



Vehicle Dynamic Control (VDC) warning light (if equipped)

When the ignition switch is in the “ON” position, the Vehicle Dynamic Control (VDC) warning light illuminates and then turns off. This indicates the VDC system is operational.

The VDC warning light blinks when the VDC system is operating.

When the warning light blinks while driving, the driving condition is slippery and the vehicle’s traction limit is about to be exceeded.

If the VDC warning light illuminates while the engine is running or while driving, it may indicate the VDC

system is not functioning properly and may need servicing. Have the system checked, and if necessary repaired, by a NISSAN dealer promptly.

If a malfunction occurs in the system, the VDC system function will be canceled but the vehicle is still driveable.

(See “Vehicle Dynamic Control (VDC) system” (P.5-14).)

INDICATOR LIGHTS



Cruise indicator light (if equipped)

The cruise indicator light indicates the activation of the cruise control system.

Cruise main switch indicator:

When the cruise control main switch is turned on, the indicator light will illuminate, indicating the cruise control system is in the standby mode.

Cruise malfunction:

If the cruise indicator light blinks while the engine is running, it may indicate the cruise control system is not functioning properly. Have the system checked by a NISSAN dealer. (See “Cruise control” (P.5-16).)



Engine start operation indicator light (if equipped)

This light appears when the shift lever is in the “P” (Park) position (Continuously Variable Transmission models) or “N” (Neutral) position (Manual Transmission models). This light means that the engine will start by pushing the ignition switch with the brake pedal (Continuously Variable Transmission models) or clutch pedal (Manual Transmission models) depressed. You can start the engine directly in any position.

 Front fog lights indicator light (if equipped)

The front fog lights indicator light illuminates when the front fog lights are on. (See “Fog light switch” (P.2-19).)

 High beam indicator light

The high beam indicator light illuminates when the headlight high beam is on. The indicator turns off when the low beam is selected. (See “Headlight and turn signal switch” (P.2-17).)

 Malfunction Indicator Light (MIL)



CAUTION:

- **Continuing vehicle operation without proper servicing of the engine control system could lead to poor drivability, reduced fuel economy, and damage to the engine control system, which may affect the vehicle’s warranty coverage.**
- **Incorrect setting of the engine control system may lead to non-compliance of local and national emission laws and regulations.**

When the ignition switch is in the “ON” position, the Malfunction Indicator Light (MIL) illuminates. After starting the engine, the MIL turns off. This indicates that the engine control system is operational.

MRA8DE (for Australia, New Zealand, Thailand and Singapore) and HR16DE engine model (for Thailand):

If the MIL illuminates while the engine is running, it may indicate that the engine control system is not functioning properly and may need servicing. Have the vehicle checked, and if necessary repaired, by a NISSAN dealer promptly.

If the MIL blinks while the engine is running, it may indicate a potential malfunction in the emission control system. In this case, the emission control system may not function properly and may need servicing. Have the vehicle checked, and if necessary repaired, by a NISSAN dealer promptly.

Precautions:

To reduce or avoid possible damage to the engine control system when the MIL blinks:

- Avoid driving at speeds above 70 km/h (43 MPH).
- Avoid sudden acceleration or deceleration.
- Avoid going up steep uphill grades.
- Avoid carrying or towing unnecessary loads.

MR16DDT, MRA8DE (except for Australia, New Zealand, Thailand and Singapore) and HR16DE engine model (except for Thailand):

If the MIL illuminates while the engine is running, it may indicate that the engine control system is not functioning properly and may need servicing. Have the vehicle checked, and if necessary repaired, by a NISSAN dealer promptly.



Security indicator light (if equipped)

The security indicator light blinks when the ignition switch is in the “LOCK”, “OFF” or “ACC” position. This function indicates the NATS (NISSAN Anti-Theft System)* equipped on the vehicle is operational.

(* immobilizer)

If NATS is malfunctioning, this light will remain on while the ignition switch is in the “ON” position. (See “Security system” (P.3-14).)



Small light indicator light

The small light indicator light illuminates when the front clearance lights, instrument panel lights, rear combination lights and license plate lights are on. The indicator light turns off when the ⏏ is turned off.



SPORT Sport mode indicator light (if equipped)

The SPORT mode indicator light illuminates when the SPORT mode is turned “ON”. (For the use of the SPORT mode switch, see “Driving with Continuously Variable Transmission (CVT)” (P.5-9).)



Trailer direction indicator light (if equipped)

The light will illuminate whenever an additional electrical load is detected by the direction indicator system.

For additional information, see “Trailer towing (for Australia and New Zealand)” (P.5-20).



Turn signals/hazard indicator lights

The turn signals/hazard indicator lights blink when the turn signal switch or hazard indicator flasher switch is turned on. (See “Headlight and turn signal switch” (P.2-17) or “Hazard indicator flasher switch” (P.6-2).)



Vehicle Dynamic Control (VDC) off indicator light (if equipped)

The Vehicle Dynamic Control (VDC) off indicator light illuminates when the VDC off switch is pushed to the “OFF” position.

When the VDC off switch is pushed to the “OFF” position, the VDC system is turned off.

(See “Vehicle Dynamic Control (VDC) system” (P.5-14).)

AUDIBLE REMINDERS

Brake pad wear warning

The disc brake pads have audible wear warnings. When a brake pad requires replacement, it will make a high pitched scraping sound when the vehicle is in motion. This scraping sound will first occur only when the brake pedal is depressed. After more wear of the brake pad, the sound will always be heard even if the brake pedal is not depressed. Have the brakes checked as soon as possible if the wear warning sound is heard.

Have the system checked, and if necessary repaired, by a NISSAN dealer promptly. (See “Brakes” (P.8-12).)

Intelligent Key buzzer (if equipped)

The Intelligent Key buzzer sounds if any one of the following improper operations is found.

- The ignition switch is not returned to the “LOCK” position when locking the doors.
- The Intelligent Key is left inside the vehicle when locking the doors.
- Any doors are not closed securely when locking the doors.

When the buzzer sounds, be sure to check both the vehicle and the Intelligent Key. (See “Intelligent Key system” (P.3-7).)

Key reminder chime

The key reminder chime will sound if any of the following operations are detected:

Model with Intelligent Key system:



- The driver’s door is opened while the ignition switch is in the “ACC” position.

Model without Intelligent Key system:

- The driver’s door is locked with the power door lock switch with the door open while the key is left in the ignition switch and the ignition switch is in the “ACC”, “OFF” or “LOCK” position.

Light reminder chime

The light reminder chime will sound if the driver’s side door is opened and the following operations are detected:

- The headlight switch is in either the  or  position, and the ignition switch is in the “ACC”, “OFF” or “LOCK” position.
- The chime will also sound for 2 seconds when the ignition switch is pushed to the “ACC”, “OFF” or “LOCK” position while the fog lights (if equipped)

are on with the headlight switch in the “AUTO” position.

Be sure to turn the headlight switch to the “OFF” or “AUTO” (if equipped) position and the fog light switch (if equipped) to the “OFF” position when you leave the vehicle.

Parking brake reminder

The chime will sound if the vehicle is driven at more than 7 km/h (4 MPH) with the parking brake applied. Stop the vehicle and release the parking brake.

HEADLIGHT AND TURN SIGNAL SWITCH

XENON HEADLIGHTS (if equipped)



WARNING:

HIGH VOLTAGE

- When xenon headlights are on, they produce a high voltage. To prevent an electric shock, never attempt to modify or disassemble. Always have your xenon headlights checked and/or replaced at a NISSAN dealer.
- Xenon headlights provide considerably more light than conventional headlights. If they are not correctly aimed, they might temporarily blind an oncoming driver or a driver ahead of you and could cause a serious accident. Immediately take your vehicle to a NISSAN dealer and have the headlights adjusted correctly.

When the xenon headlights are initially turned on, their brightness and color vary slightly. However, the color and brightness will soon stabilize.

The life of xenon headlights will be shortened by frequent on-off operation. It is generally desirable not to turn off the headlights for short intervals.

If the xenon headlight bulb is close to burning out, the brightness will drastically decrease, the headlight will start blinking, or the color of the headlight will become reddish. If one or more of the above conditions appear, contact a NISSAN dealer.

HEADLIGHT SWITCH

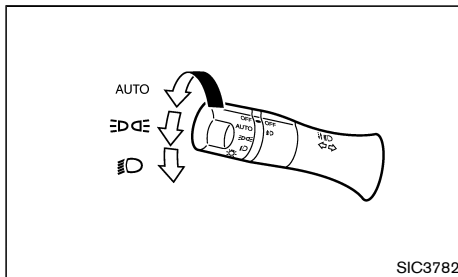

Type A

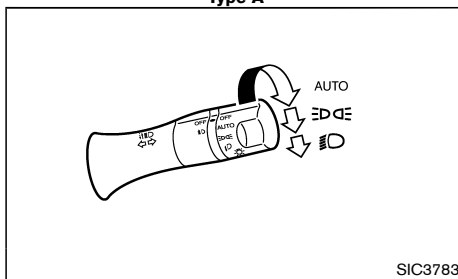

Type B

NISSAN recommends that you consult the local regulations concerning the use of lights.

AUTO position (if equipped)

When the ignition switch is in the "ON" position and the headlight switch is in the "AUTO" position, the headlights, front clearance lights, instrument panel lights, rear combination lights and other lights turn on automatically depending on the brightness of the surroundings.

The headlights will turn on automatically at twilight or in rainy weather (when the windshield wiper is operated

continuously).

When the ignition switch is placed in the "OFF" position, the lights will turn off automatically.

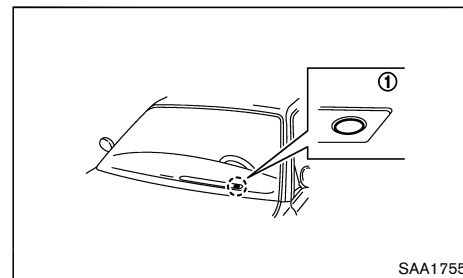



CAUTION:

Do not place any objects on top of the sensor ①. The sensor senses the brightness level and controls the autolight function. If the sensor is covered, it reacts as if it is dark, and the headlights will illuminate.

 position

The  position turns on the front clearance, instrument panel, tail and license plate lights.

 position

The  position turns on the headlights in addition to the other lights.

Headlight beam

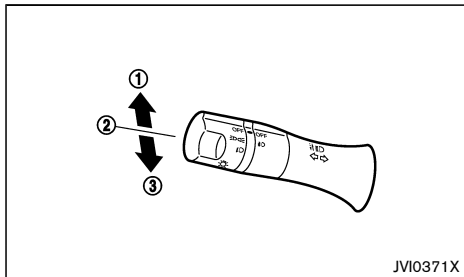

Type A

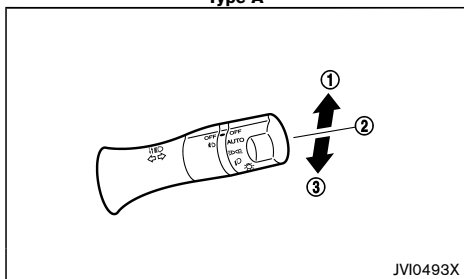

Type B

To turn on the high beam, push the lever towards the front position ①.

To turn off the high beam, return the lever to the neutral position ②.

To flash the headlights, pull the lever towards the rearmost position ③. The headlights can be flashed even when the headlights are not on.

Battery saver system

The light reminder chime will sound if the driver's door is opened while the following operations occur:

- The headlight switch is in either the ① or ② position, and the ignition switch in the "ACC", "OFF" or "LOCK" position.

Be sure to turn the headlight switch to the "OFF" position when you leave the vehicle.

If the doors are closed and locked with the remote keyless entry or Intelligent Key system while the headlight switch is in either the ① or ② position, the battery saver function will turn off the lights to prevent the battery from being discharged. The lights will turn on when the doors are being opened.



CAUTION:

Do not leave the lights on when the engine is not running for extended periods of time to prevent the battery from being discharged.

HEADLIGHT AIMING CONTROL (if equipped)

Manual type

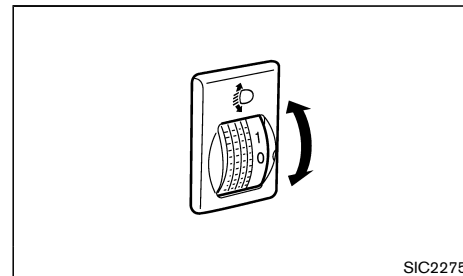

The headlight aiming control operates when the ignition switch is in the "ON" position and the headlight is on to allow the headlight axis to be adjusted according to the driving condition.

When driving with no heavy load/luggage or driving on a flat road, select the normal position "0".

If the number of occupants and load/luggage in the vehicle changes, the headlight axis may become higher than normal.

If the vehicle is traveling on a hilly road, the headlights may directly shine on the rearview and outside mirrors of a vehicle ahead or the windshield of an oncoming vehicle, which may obscure other drivers' vision.

To adjust to the proper aiming height, turn the switch accordingly. The higher the number, designated on the switch, the lower the headlight axis.

Automatic type

For the vehicle equipped with the automatic leveling system, the headlight axis is controlled automatically.

TURN SIGNAL SWITCH

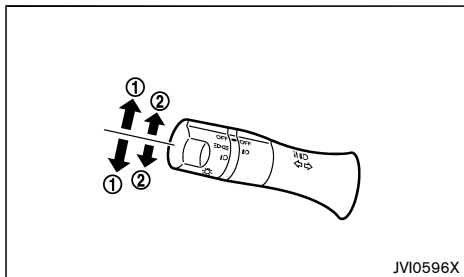

Type A

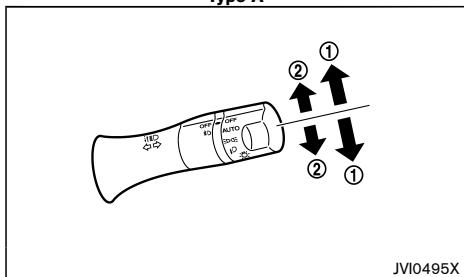

Type B



CAUTION:

The turn signal switch will not be cancelled automatically if the steering wheel turning angle does not exceed the preset amount. After a turn or lane change, make sure that the turn signal switch is returned to its original position.

Turn signal

To turn on the turn signals, move the lever up or down ① to the point where the lever latches. When the turn is completed, the turn signal cancels automatically.

Lane change signal

To turn on the lane change signals, move the lever up or down ② to the point where the light begins to flash.

If the lever is moved back to its original position right after moving up or down, the light will flash 3 times.

To cancel the flashing, move the lever to the opposite direction.

FOG LIGHT SWITCH (if equipped)

FRONT FOG LIGHTS

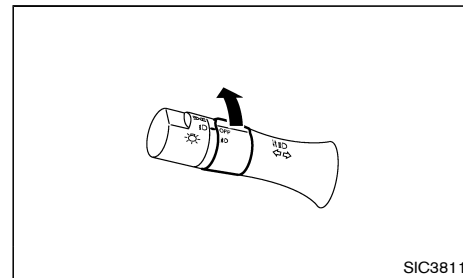

Type A

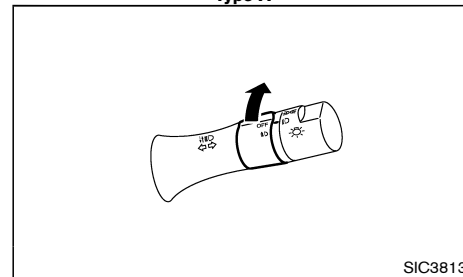

Type B

To turn on the front fog lights, turn the fog light switch to the ☞ position with the headlight switch in the ☞ or ☝ position.

To turn off the fog lights, turn the fog light switch to the "OFF" position.

When the headlight switch is in the "AUTO" position (if equipped), turning the fog light switch to the ☞ position will turn on the headlights, fog lights and the other lights.

WIPER AND WASHER SWITCH

WARNING:

In freezing temperatures, the washer fluid may freeze on the windshield and obscure your vision. Warm the windshield with the defogger before you wash the windshield.

CAUTION:

- Do not operate the washer continuously for longer than 30 seconds.
- Do not operate the washer if the window washer fluid reservoir is empty.
- If the wiper operation is interrupted by snow or ice, the wiper may stop moving to protect its motor. If this occurs, turn the wiper switch to the “OFF” position and remove the snow or ice on and around the wiper arms. In approximately 1 minute, turn the switch on again to operate the wiper.

WINDSHIELD WIPER AND WASHER SWITCH

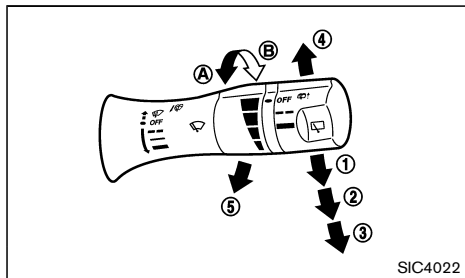

Type A

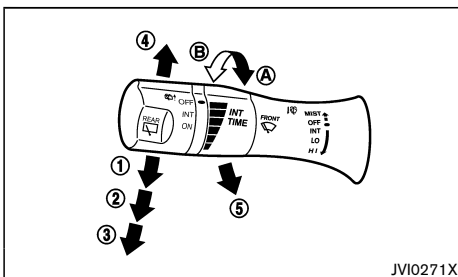

Type B

The windshield wiper and washer operate when the ignition switch is in the “ON” position.

Wiper operation

The lever position “INT” or “” ① operates the wiper intermittently.

- The intermittent operation can be adjusted by turning the adjustment control knob, (longer) **A** or (shorter) **B** .
- The intermittent operation speed varies in accordance with the vehicle speed. (For example, when the vehicle speed is high, the intermittent operation speed will be faster.)

The lever position “LO” or “” ② operates the wiper at low speed.

The lever position “HI” or “” ③ operates the wiper at high speed.

To stop the wiper operation, move the lever up to the “OFF” position.

The lever position “MIST” or “” ④ operates the wiper one sweep. The lever automatically returns to its original position.

Pulling up the wiper arm:

The wiper arm should be in the up position when replacing the wiper.

To pull up the wiper arm, pull the lever **5** when the ignition switch is in the “OFF” position within 1 minute. The wiper operation stops in mid-operation and the wiper arm can be pulled up.

To replace the wiper arm, place the wiper arm in the down position and then push the lever **4** up once when the ignition switch is in the “ON” position.

Washer operation

To operate the washer, pull the lever toward the back of the vehicle **5** until the desired amount of washer fluid is spread on the windshield. The wiper will automatically operate several times.

Wiper drip wipe system:

The wiper will also operate once about 3 seconds after the washer and wiper are operated. This operation is to wipe washer fluid that has dripped on the windshield.

Headlight cleaner (if equipped)

Pull the lever toward the rear of the vehicle **5** .

The headlight cleaner will operate with operation of the windshield washer.

- The headlight cleaner operates with the windshield washer operation. This operation activates once each time either the ignition switch or the headlight switch is turned off and on.
- After the first operation, the headlight cleaner operates once for every few operations of the windshield washer.

CAUTION:

Do not operate the headlight cleaner if the window washer fluid reservoir is empty.

REAR WINDOW WIPER AND WASHER SWITCH

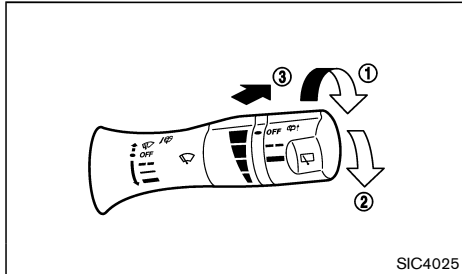

SIC4025

Type A

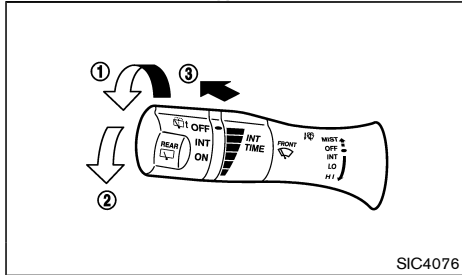

SIC4076

Type B

The rear window wiper and washer operate when the ignition switch is in the "ON" position.

Wiper operation

Turn the switch from the "OFF" position to operate the wiper.

- ① "INT" or "■" (intermittent) — intermittent operation (not adjustable)
- ② "ON" or "■" (low) — continuous low speed operation

Reverse synchronization function (if equipped):

When the windshield wiper switch is on, moving the shift lever to the "R" (Reverse) position will operate the rear window wiper.

Washer operation

Push the switch forward ③ to operate the washer. Then the wiper will also operate several times.

DEFOGGER SWITCH

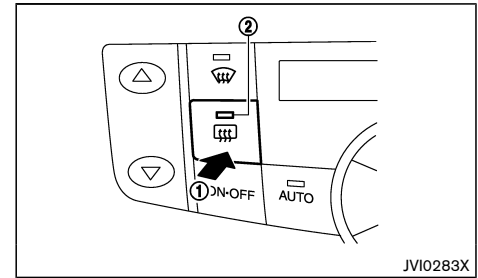

JV10283X

Type A*

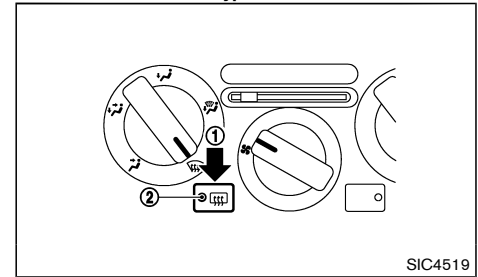

SIC4519

Type B

*: The illustration is for the Left-Hand Drive (LHD) model. For the Right-Hand Drive (RHD) model, the layout will be the opposite.

The defogger switch operates when the ignition switch is in the "ON" position.

The defogger is used to reduce the moisture, fog or frost on the rear window surface to improve the rear view.

When the defogger switch ① is pushed, the indicator light ② illuminates and the rear window defogger operates for approximately 15 minutes. After the preset time has passed, the defogger will turn off automati-

cally.

To turn off manually, push the defogger switch again.



CAUTION:

- **When operating the defogger continuously, be sure to start the engine. Otherwise, it may cause the battery to discharge.**
- **When cleaning the inner side of the window, be careful not to scratch or damage the electrical conductors on the surface of the window.**

HORN

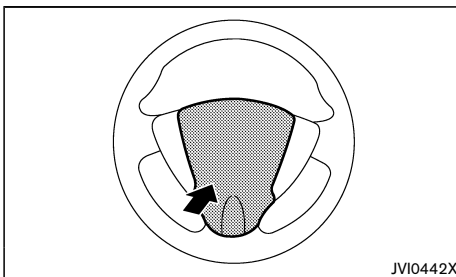

The horn switch operates regardless of the ignition switch position except when the battery is discharged.

When the horn switch is pushed and held, the horn will sound. Releasing the horn switch will cease the horn sound.

WINDOWS

POWER WINDOWS



WARNING:

- **Make sure that all passengers have their hands, etc. inside the vehicle before operating the power windows.**
- **Never leave children or adults who would normally require the support of others alone in the vehicle. They could unknowingly activate switches or controls and inadvertently become involved in an accident.**

The power windows operate when the ignition switch is in the "ON" position.

To open a window, push down the power window switch.

To close a window, pull up the power window switch.

Driver's window switch

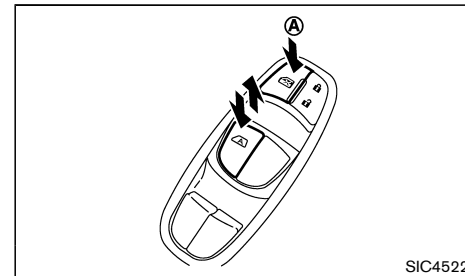

The driver's switch, the main switch, can control all windows.

Locking passengers' windows:

When the lock button **(A)** is pushed in, the passengers' windows cannot be operated.

To cancel the passengers' windows lock, push the lock button **(A)** again to release the passengers' window lock.

Passenger's window switch

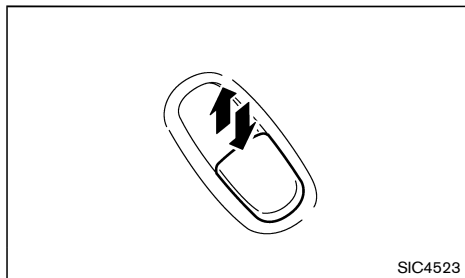

The passenger's switch can control its corresponding window.

When the passengers' windows lock button on the driver's switch is pushed in, the passenger's switch cannot be operated.

Automatic function

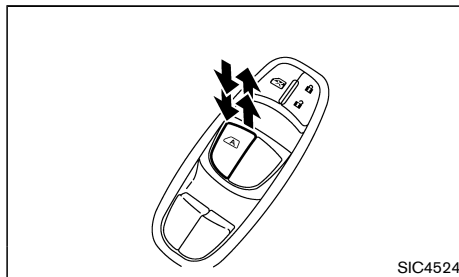

The automatic function is available for the switch that has an **(A)** mark on its surface.

The automatic function enables a window to fully open or close without holding the switch down or up.

To fully open the window, push the power window switch down to the second detent and release the switch. To fully close the window, pull the power window switch up to the second detent and release the switch. The switch does not have to be held during window operation.

To stop the window open/close operation during the automatic function, push down or pull up the switch in opposite directions.

Auto-reverse function:



WARNING:

There is a small distance just before the closed position which cannot be detected. Make sure that all passengers have their hands, etc. inside the vehicle before closing the windows.

The auto-reverse function enables a window to automatically reverse when something is caught in

the window as it is closing by the automatic function. When the control unit detects an obstacle, the window will be lowered immediately.

Depending on the environment or driving conditions, the auto-reverse function may activate if an impact or load similar to something being caught in the window occurs.

If the window does not close automatically

If the power window automatic function (closing only) does not operate properly, perform the following procedure to initialize the power window system.

1. Place the ignition switch in the "ON" position.
2. Close the door.
3. Open the window completely by operating the power window switch.
4. Pull the power window switch and hold it to close the window, and then hold the switch more than 3 seconds after the window is closed completely.
5. Release the power window switch. Operate the window by the automatic function to confirm the initialization is complete.

If the power window automatic function does not operate properly after performing the procedure above, have your vehicle checked by a NISSAN dealer.

SUNROOF (if equipped)

WARNING:

- In an accident you could be thrown from the vehicle through an open sunroof. Adults should always use seat belts and children should always use seat belts or child restraint systems.
- Never allow anyone to stand up or extend any portion of their body out of the opening while the vehicle is in motion or while the sunroof is closing.

CAUTION:

- Remove water drops, snow, ice or sand from the sunroof before opening.
- Do not place any heavy objects on the sunroof or surrounding area.

AUTOMATIC SUNROOF

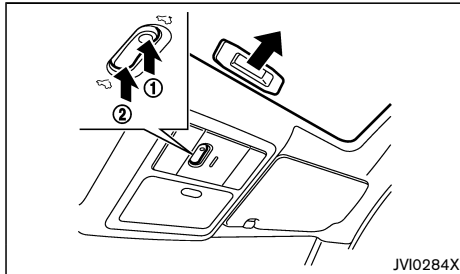

The sunroof operates when the ignition switch is in the "ON" position.



Sunshade

To open or close the sunshade, slide the sunshade manually.



The sunshade will open automatically when the sunroof is opened. The sunshade needs to be closed manually by sliding it.

Sunroof

Tilting:

To tilt up, first close the sunroof, then push the UP side  of the sunroof switch and release it; it need not be held. To tilt down the sunroof, push the DOWN side .

Sliding:

To fully open or close the sunroof, push the OPEN  or CLOSE  side of the sunroof switch and release it; it need not be held. The roof will automatically open or close all the way. To stop the sunroof, push the switch once more while it is opening or closing.

Auto-reverse function

WARNING:

There is a small distance just before the closed position which cannot be detected. Make sure that all passengers have their hands, etc. inside the vehicle before closing the sunroof.



The auto-reverse function enables the sunroof to automatically reverse when something is caught in the sunroof as it is closing. When the control unit detects an obstacle, the sunroof will open immediately.

If the sunroof cannot be closed automatically when the auto reverse function activates due to a malfunction, push and hold the CLOSE side  of the sunroof switch.

Depending on the environment or driving conditions, the auto-reverse function may activate if an impact or load similar to something being caught in the sunroof occurs.

If sunroof does not operate

If the sunroof does not operate properly, perform the following procedure to initialize the sunroof operation system.

1. If the sunroof is open, close it fully by repeatedly pushing the CLOSE side  of the sunroof switch.
2. Push and hold the CLOSE side  of the sunroof switch to tilt the sunroof up.
3. Release the sunroof switch after the sunroof moves slightly up and down.
4. Push and hold the OPEN side  of the sunroof switch to fully tilt the sunroof down.
5. Check if the sunroof switch operates normally.

If the sunroof does not operate properly after performing the procedure above, have your vehicle checked by a NISSAN dealer.

POWER OUTLET (if equipped)

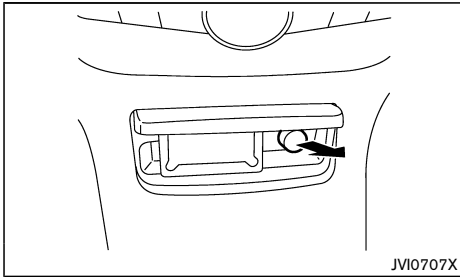

The power outlet is for powering electrical accessories.

CAUTION:

- The outlet and plug may be hot during or immediately after use.
- This power outlet is not designed for use with a cigarette lighter unit.
- Do not use with accessories that exceed a 12 volt, 120W (10A) power draw. Do not use double adapters or more than one electrical accessory.
- Use power outlet with the engine running to avoid discharging the vehicle battery.
- Avoid using power outlet when the air conditioner, headlights or rear window defogger is on.
- Before inserting or disconnecting a plug, be sure to turn off the power switch of the electrical accessory being used and the ignition switch.
- Push the plug in as far as it will go. If good contact is not made, the plug may overheat or the internal temperature fuse may blow.

- Do not allow water to contact the outlet.
- When not in use, be sure to close the cap.

ASHTRAY AND CIGARETTE LIGHTER (if equipped)

FRONT

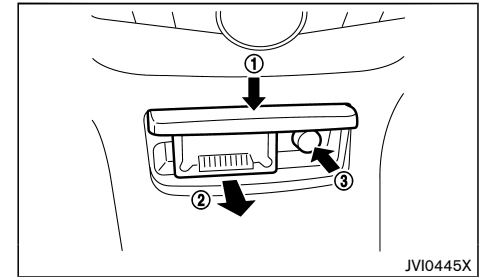

Ashtray

To open the ashtray, push the lid ① .

To take out the ashtray, pull out ② .

Cigarette lighter

WARNING:

The cigarette lighter should not be used while driving so that full attention may be given to vehicle operation.

CAUTION:

- The cigarette lighter socket is a power source for the cigarette lighter element only. The use of the cigarette lighter socket as a power source for any other accessory is not recommended.
- Do not use any other power outlet for an accessory lighter.

The cigarette lighter operates when the ignition switch is in the "ACC" or "ON" position. To heat the cigarette

lighter, push in ③ until it latches. When the lighter is heated, it will spring out automatically.

Return the cigarette lighter to its original position after use.

REAR

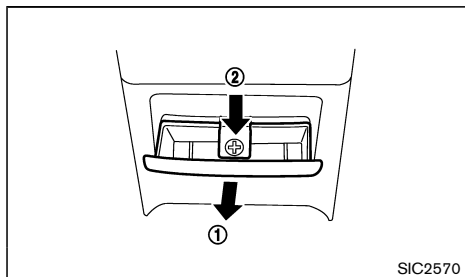

To open the ashtray, pull ①.

To take out the ashtray, push down ②, and pull out.

STORAGES

WARNING:

- **The storages should not be used while driving so that the full attention may be given to vehicle operation.**
- **Keep the storage lids closed while driving to help prevent injury in an accident or sudden stop.**

GLOVE BOX

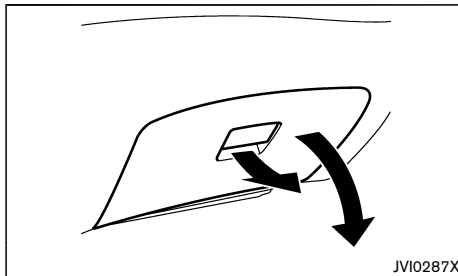

Type A

To open the glove box, pull the handle.

To close, push the lid in until the lock latches.

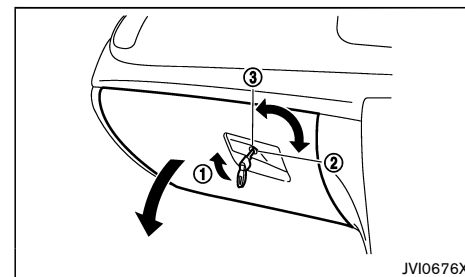

Type B

To open the glove box, pull the handle ①.

To close, push the lid in until the lock latches.

To lock ② /unlock ③ the glove box, use the key.

CONSOLE BOX

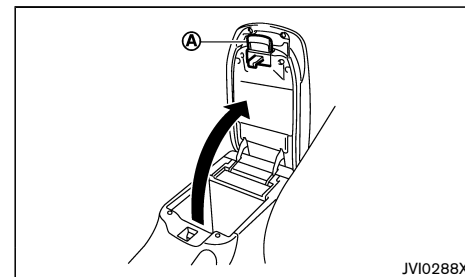

To open the console box lid, push the knob (A) and pull up the lid.

To close, push the lid down until the lock latches.

CUP HOLDERS

WARNING:

The driver must not remove or insert cups into the cup holder while driving so that full attention may be given to vehicle operation.

CAUTION:

Avoid abrupt starting and braking especially when the cup holder is being used to prevent spilling the contents. If the contents are hot, they could scald you or your passengers.

Front

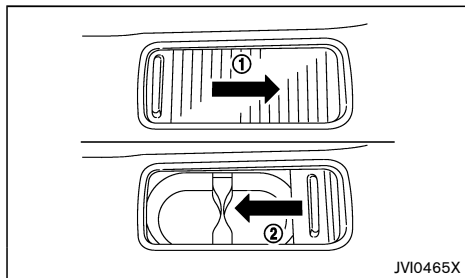

JVI0465X

To open the cup holder, slide the lid ①.

To close the cup holder, slide the lid ②.

Rear (if equipped)

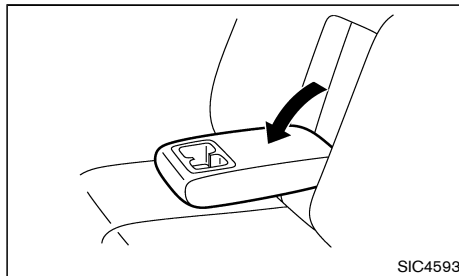

SIC4593

Soft bottle holders

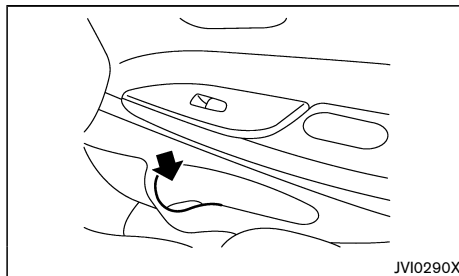

JVI0290X

Soft bottle holders are located on the front and rear doors.

CAUTION:

- Do not use bottle holder for any other objects that could be thrown about in the vehicle and possibly injure people during sudden braking or an accident.

- Do not use bottle holder for open liquid containers.

SUNGLASSES HOLDER

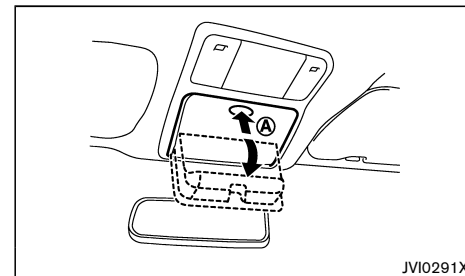

JVI0291X

CAUTION:

- Do not use for anything other than sunglasses.
- Do not leave sunglasses in the sunglasses holder while parking in direct sunlight. The heat may damage the sunglasses.

To open the sunglasses holder, push the button  .
To close, push the holder up until the lock latches.

COAT HOOK (if equipped)

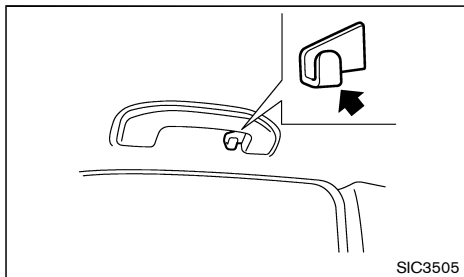

The coat hook is located above the rear side window (on the driver's side).



CAUTION:

Do not apply a total load of more than 2 kg (4 lb) to the hook.

CARD HOLDERS (if equipped)

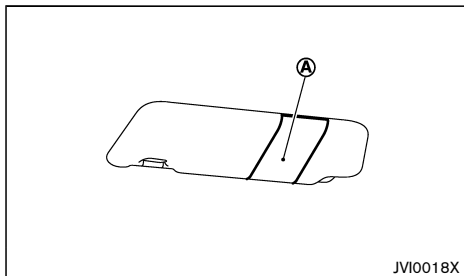

Slide a card in the card holder **A**.

CARGO COVER



WARNING:

- **Never put anything on the cargo cover, no matter how small. Any object on it could cause an injury in an accident or sudden stop.**
- **Do not leave the cargo cover in the vehicle with it disengaged from the holder.**
- **The child restraint top tether strap (if equipped) may be damaged by contact with the cargo cover or items in the luggage area. Remove the cargo cover from the vehicle or secure it and any luggage. Your child could be seriously injured or killed in a collision if the top tether strap is damaged.**
 - **If the cargo cover contacts the top tether strap when it is attached to the top tether anchor, remove the cargo cover from the vehicle or secure it on the cargo floor below its attachment location. If the cargo cover is not removed, it may damage the top tether strap during a collision.**
 - **Do not allow cargo to contact the top tether strap when it is attached to the top tether anchor. Properly secure the cargo so it does not contact the top tether strap. Cargo that is not properly secured or that contacts the top tether strap may damage the top tether strap during a collision.**

The cargo cover keeps the luggage compartment contents hidden from the outside.

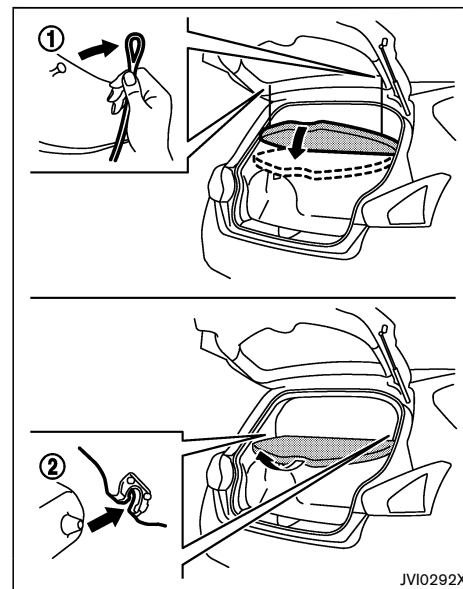

To remove the cargo cover:

1. Remove the straps **1** from the back door.
2. Remove the cargo cover holders **2**.

SUN VISORS

LUGGAGE HOOKS (if equipped)

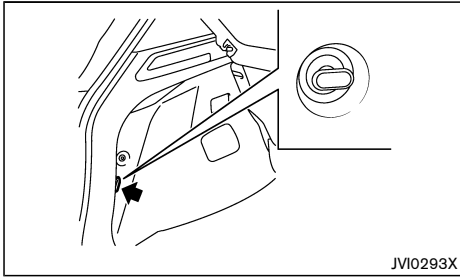

The hooks are located in the luggage area.



CAUTION:

Do not apply a total load of more than 3 kg (7 lb) to a single hook.

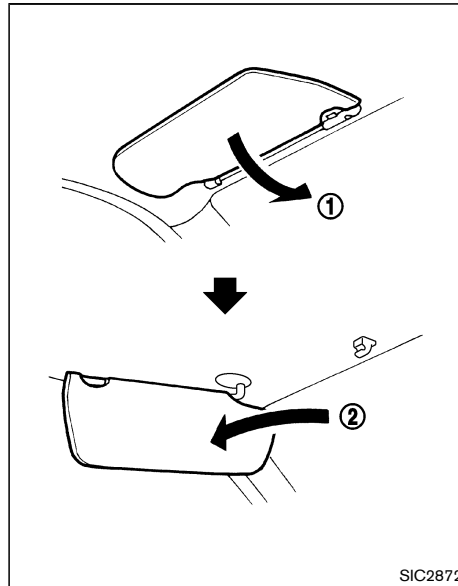

1. To block out glare from the front, swing down ① the sun visor.
2. To block glare from the side, remove the sun visor from the center mount and swing it to the side ②.

INTERIOR LIGHTS



CAUTION:

- Do not leave the light switch on when the engine is not running for extended periods of time to prevent the battery from being discharged.
- Turn off the lights when you leave the vehicle.

ROOM LIGHT

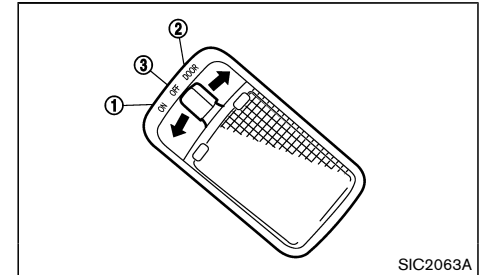

The room light has a three-position switch.

When the switch is in the "ON" position ①, the room light illuminates.

When the switch is in the "DOOR" position ②, the room light illuminates when a door is opened.

The interior light timer will keep the room light on for approximately 15 seconds when:

- The key is removed from the ignition switch with the driver's door closed. (model without Intelligent Key system)
- The ignition switch is placed in the "OFF" position. (model with Intelligent Key system)

- The doors are unlocked by pushing the “UN-LOCK”  button (on the remote controller or Intelligent Key) or the request switch (Intelligent Key system equipped models), with the ignition switch in the “LOCK” position.
- Any door is opened and then closed with the ignition switch in the “LOCK” position.

The interior light timer will be cancelled when:

- The driver’s door is locked.
- The ignition switch is placed in the “ON” position.

When the switch is in the “OFF” position , the room light does not illuminate, regardless of any condition.

Battery saver system

If any door is left open for a period of time with the room light switch in the “DOOR” position, the room light will automatically turn off.

MAP LIGHTS

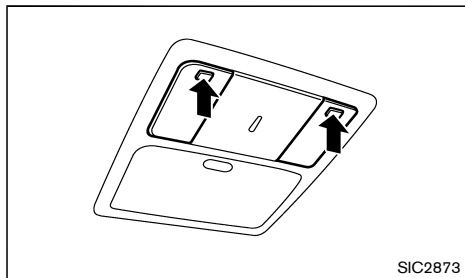

To turn the map lights on, press the lenses. To turn them off, press the lenses of the lights again.

VANITY MIRROR LIGHTS (if equipped)

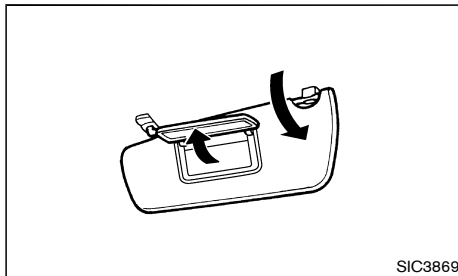

To access the vanity mirror, pull the sun visor down and flip open the mirror cover.

The vanity mirror light illuminates when the vanity mirror cover is opened. When the cover is closed, the light will turn off.

CARGO ROOM LIGHT

The cargo room light illuminates when the back door is opened. When the back door is closed, the lights will turn off.

3 Pre-driving checks and adjustments

Keys	3-2	Using remote keyless entry function	3-12
Key (if equipped)	3-2	Hazard indicator and outside chime operation	3-13
NISSAN Anti-Theft System (NATS) key (if equipped)	3-2	Security system (if equipped)	3-14
Intelligent Key (if equipped)	3-2	NISSAN Anti-Theft System (NATS)	3-14
Door locks	3-3	Hood	3-14
Locking with key	3-3	Opening hood	3-15
Locking with inside lock knob	3-4	Closing hood	3-15
Locking with power door lock switch	3-4	Back door	3-15
Vehicle speed sensing door lock mechanism (if equipped)	3-4	Opening back door	3-16
Auto door lock releasing mechanism (if equipped)	3-4	Closing back door	3-16
Impact sensing door lock releasing mechanism		Back door release lever	3-16
(if equipped)	3-5	Fuel filler lid	3-17
Child safety rear door lock	3-5	Opening fuel filler lid	3-17
Remote keyless entry system (if equipped)	3-5	Fuel filler cap	3-17
Using remote keyless entry system	3-6	Steering wheel	3-17
Intelligent Key system (if equipped)	3-7	Tilt or telescopic operation	3-17
Operating range	3-8	Mirrors	3-18
Using Intelligent Key system	3-8	Inside rearview mirror	3-18
Battery saver system	3-10	Outside rearview mirrors	3-18
Warning and audible reminders	3-10	Vanity mirror (if equipped)	3-19
Troubleshooting guide	3-11	Parking brake	3-19

KEYS

Your vehicle can only be driven with the keys specific to your vehicle. A key number plate is supplied with your key. Record the key number and keep the key number plate in a safe place, except in the vehicle, in case of the need to duplicate the keys.

The key can only be duplicated using an original key or the original key number. The key number is required when you have lost all of the keys and do not have the original key to duplicate from. If the key is lost, or you need extra keys, provide an original key or the key number to a NISSAN dealer.



CAUTION:

Do not leave the keys inside the vehicle when leaving the vehicle.

KEY (if equipped)

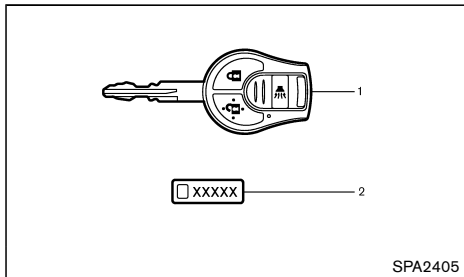

1. Master key (2)
2. Key number plate

As many as 5 master keys with remote controller can be registered and used with one vehicle.

NISSAN ANTI-THEFT SYSTEM (NATS*) KEY (if equipped)

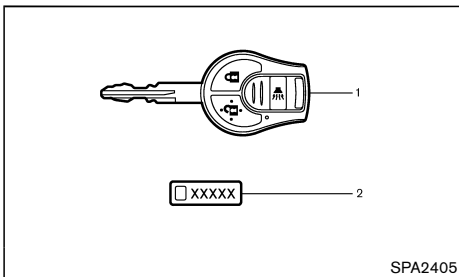

1. NATS key (2)
2. Key number plate

Your vehicle can only be driven with the NATS keys, which are registered to your vehicle's NATS components. As many as 5 NATS keys can be registered and used with one vehicle. The new keys must be registered by a NISSAN dealer prior to use with the NATS of your vehicle. Since the registration process requires erasing all memory in the NATS components when registering new keys, be sure to take all NATS keys that you have to the NISSAN dealer.

*: Immobilizer



CAUTION:

Do not allow the NATS key, which contains an electrical transponder, to come into contact with water or salt water. This could affect the system function.

INTELLIGENT KEY (if equipped)

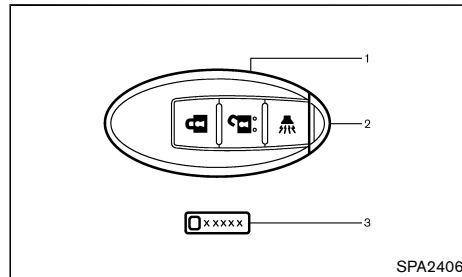

1. Intelligent Key (2)
2. Mechanical key (inside the Intelligent Key) (2)
3. Key number plate

Your vehicle can only be driven with the Intelligent Keys, which are registered to your vehicle's Intelligent Key system components and NISSAN Anti-Theft System (NATS*) components. As many as 4 Intelligent Keys can be registered and used with one vehicle. The new keys must be registered by a NISSAN dealer prior to use with the Intelligent Key system and NATS of your vehicle. Since the registration process requires erasing all memory in the Intelligent Key components when registering new keys, be sure to take all Intelligent Keys that you have to the NISSAN dealer.

*: Immobilizer



CAUTION:

- **Be sure to carry the Intelligent Key with you. Do not leave the vehicle with the Intelligent Key inside.**
- **Be sure to carry the Intelligent Key with you when driving. The Intelligent Key is a precision device with a built-in transmitter. To**

avoid damaging it, please note the following.

- The Intelligent Key is water resistant; however, wetting may damage the Intelligent Key. If the Intelligent Key gets wet, immediately wipe until it is completely dry.
- Do not bend, drop or strike it against another object.
- If the outside temperature is below -10°C (14°F), the battery of the Intelligent Key may not function properly.
- Do not place the Intelligent Key for an extended period in a place where temperatures exceed 60°C (140°F).
- Do not change or modify the Intelligent Key.
- Do not use a magnet key holder.
- Do not place the Intelligent Key near equipment that produces a magnetic field such as a TV, audio equipment and personal computers.
- Do not allow the Intelligent Key to come into contact with water or salt water, and do not wash it in a washing machine. This could affect the system function.
- If an Intelligent Key is lost or stolen, NISSAN recommends erasing the ID code of that Intelligent Key. This will prevent the Intelligent Key from unauthorized use to unlock the vehicle. For information regarding the erasing procedure, please contact a NISSAN

dealer.

Mechanical key

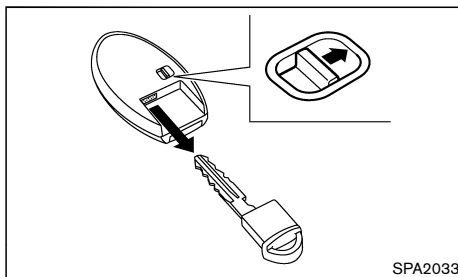

To remove the mechanical key, release the lock knob at the back of the Intelligent Key.

To install the mechanical key, firmly insert it into the Intelligent Key until the lock knob returns to the lock position.

Use the mechanical key to lock or unlock the doors and glove box, if equipped with a key cylinder. (See “Door locks” (P.3-3) and “Storages” (P.2-26).)

DOOR LOCKS



WARNING:

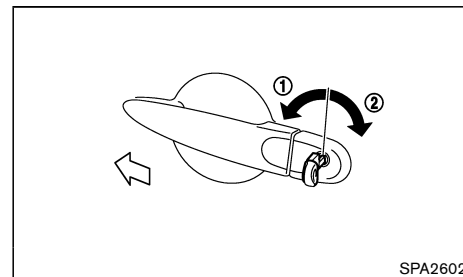

- Always look before opening any doors, to avoid an accident with oncoming traffic.
- Never leave children or adults who would normally require the support of others alone in the vehicle. They could unknowingly activate switches or controls and inadvertently become involved in a serious accident.

LOCKING WITH KEY



To lock the door, insert the key to the door key cylinder and turn the key to the front side of the vehicle ①. The driver's side door will lock.

To unlock the door, turn the key to the rear of the vehicle ②. The driver's side door will unlock.

To lock or unlock the other doors, use the power door lock switch, the “LOCK”  button or “UNLOCK”  button on the remote controller, Intelligent Key or any request switch.

LOCKING WITH INSIDE LOCK KNOB

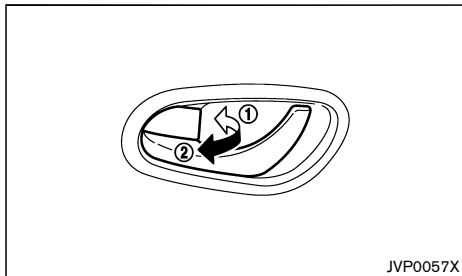

CAUTION:

When locking the doors using the inside lock knob, be sure not to leave the key in the vehicle.

To lock the front doors, push the inside lock knob to the lock position ①, and then close the door while pulling the door handle.

To lock the rear doors, push the inside lock knob to the lock position ① and then close the door.

To unlock, pull the inside lock knob to the unlock position ②.

LOCKING WITH POWER DOOR LOCK SWITCH

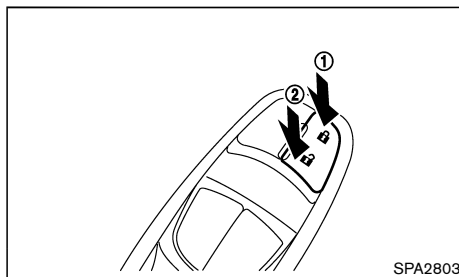

CAUTION:

When locking the doors using the power door lock switch, be sure not to leave the key in the vehicle.

To lock the doors, push the power door lock switch to the lock position ① with the driver's door open, then close the door while pulling the door handle. All doors including the back door will lock.

To unlock, push the power door lock switch to the unlock position ②.

Lockout protection

The power door lock switch will not lock the doors under the following conditions:

Model without Intelligent Key system:

- When the key is in the ignition switch and the driver's door is open.
- When any door except for the driver's door is open.

Model with Intelligent Key system:

- When the Intelligent Key is left inside of the vehicle and driver's door is open.

VEHICLE SPEED SENSING DOOR LOCK MECHANISM (if equipped)

All doors will be locked automatically when the vehicle speed reaches 10 km/h (6 MPH). Once the lock has been unlocked, while driving, the vehicle speed sensing door lock mechanism will not lock the door again unless one of the following is performed.

- Opening any doors.
- Placing the ignition switch in the "LOCK" position.

To activate or deactivate vehicle speed sensing door lock mechanism

To activate or deactivate the door lock mechanism, perform the following procedures.

1. Place the ignition switch in the "ON" position.
2. Within 20 seconds, push and hold the power door lock switch to the "LOCK" position for 5 seconds.
3. The hazard indicator light will flash as follows if the switching operation is successful:

- Twice — activated
- Once — deactivated

AUTO DOOR LOCK RELEASING MECHANISM (if equipped)

All doors will be unlocked automatically when the following conditions:

- When the ignition switch is moved from "ON" to "OFF" position (Model with Intelligent Key system).
- When the key is removed from the ignition switch (Model without Intelligent Key system).

To activate or deactivate auto door lock releasing mechanism

To activate or deactivate the auto door lock releasing mechanism, perform the following procedures.

1. Place the ignition switch in the "ON" position.
2. Within 20 seconds, push and hold the power door lock switch to the "UNLOCK" position for 5 seconds.
3. The hazard indicator light will flash as follows if the switching operation is successful:
 - Twice — activated
 - Once — deactivated

IMPACT SENSING DOOR LOCK RELEASING MECHANISM (if equipped)

All doors will be unlocked automatically when the impact sensors sense an impact while the ignition switch is in the "ON" position.

CHILD SAFETY REAR DOOR LOCK

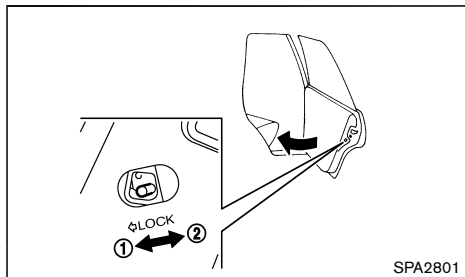

The child safety rear door locks help prevent rear doors from being opened accidentally, especially when small children are in the vehicle.

When the levers are in the lock position ①, the child

safety rear door locks engage and the rear doors can only be opened by the outside door handles.

To disengage, move the levers to the unlock position ②.

REMOTE KEYLESS ENTRY SYSTEM (if equipped)

The remote keyless entry system can operate all door locks (including the back door) using the remote controller. The remote controller can operate at a distance of approximately 1 m (3.3 ft) away from the vehicle. The operating distance depends upon the conditions around the vehicle.

As many as 5 remote controllers can be used with one vehicle. For information about the purchase and use of additional remote controllers, contact a NISSAN dealer.

The remote controller will not function under the following conditions:

- When the distance between the remote controller and vehicle is more than approximately 1 m (3.3 ft).
- When the remote controller battery is discharged.
- When the key is in the ignition switch.



CAUTION:

- **When locking the doors using the remote controller, be sure not to leave the key in the vehicle.**
- **Do not allow the remote controller, which contains electrical components, to come into contact with water or salt water. This could affect the system function.**
- **Do not drop the remote controller.**
- **Do not strike the remote controller sharply against another object.**
- **If the outside temperature is below -10°C (14°F), the battery of the remote controller may not function properly.**
- **Do not place the remote controller for an extended period in an area where tempera-**

tures exceed 60°C (140°F).

If a remote controller is lost or stolen, NISSAN recommends erasing the ID code of that remote controller from the vehicle. This may prevent the unauthorized use of the remote controller to unlock the vehicle. For information regarding the erasing procedure, contact a NISSAN dealer.

For information regarding the replacement of a battery, see "Battery" (P.8-18).

USING REMOTE KEYLESS ENTRY SYSTEM

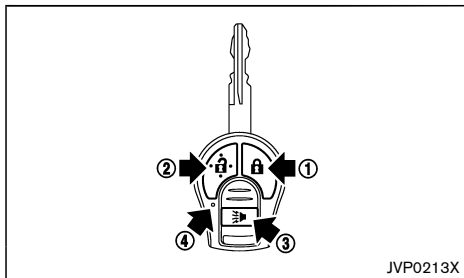

- ① LOCK button
- ② UNLOCK button
- ③ PANIC button
- ④ Battery indicator light

Locking doors

1. Remove the ignition key.
2. Close all doors.
3. Push the "LOCK" button ① on the remote controller.
4. All doors will be locked.
5. Operate door handles to confirm that the doors have been securely locked.



CAUTION:

After locking the doors using the remote controller, be sure that the doors have been securely locked by operating the door handles.

Unlocking doors

1. Push the "UNLOCK" button ② on the remote controller.
2. All doors will be unlocked.

All doors will be locked automatically unless one of the following operations is performed within 30 seconds after pushing the "UNLOCK" button ② .

- Opening any doors.
- Inserting the key into the ignition switch.

Using panic alarm

If you are near your vehicle and feel threatened, you may activate the alarm to call attention as follows:

1. Push the "PANIC" button ③ on the remote controller for **more than 1 second**.
2. The theft warning alarm will stay on for 25 seconds.
3. The panic alarm stops when:
 - It has run for 25 seconds, or
 - Any of the buttons on the remote controller is pushed. (Note: PANIC button should be pushed for more than 1 second.)

Battery indicator light

The battery indicator light ④ illuminates when you push any button. If the light does not illuminate, the battery is weak or needs replacement. For information regarding replacement of a battery, see "Remote controller battery" (P.8-19).

Hazard indicator operation

When you lock or unlock the doors, the hazard indicator will flash as a confirmation.

- "LOCK": The hazard indicator flashes once.
- "UNLOCK": The hazard indicator flashes twice.

INTELLIGENT KEY SYSTEM (if equipped)

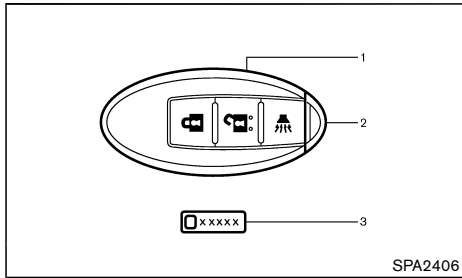

1. Intelligent Key (2)
2. Mechanical key (inside the Intelligent Key) (2)
3. Key number plate

WARNING:

- **Radio waves could adversely affect electric medical equipment. Those who use a pacemaker should contact the electric medical equipment manufacturer for the possible influences before use.**
- **The Intelligent Key transmits radio waves when the buttons are pushed. The radio waves may affect aircraft navigation and communication systems. Do not operate the Intelligent Key while on an airplane. Make sure the buttons are not operated unintentionally when the unit is stored during a flight.**

The Intelligent Key system can operate all the door (including the back door) locks using the remote controller function or pushing the request switch on the vehicle without taking the key out from a pocket or purse. The operating environment and/or conditions may affect the Intelligent Key system operation.

Be sure to read the following before using the Intelligent Key system.

CAUTION:

- **Be sure to carry the Intelligent Key with you when operating the vehicle.**
- **Never leave the Intelligent Key in the vehicle when you leave the vehicle.**

The Intelligent Key is always communicating with the vehicle as it receives radio waves. The Intelligent Key system transmits weak radio waves. Environmental conditions may interfere with the operation of the Intelligent Key system under the following operating conditions.

- When operating near a location where strong radio waves are transmitted, such as a TV tower, power station and broadcasting station.
- When in possession of wireless equipment, such as a cellular telephone, transceiver, and CB radio.
- When the Intelligent Key is in contact with or covered by metallic materials.
- When any type of radio wave remote control is used nearby.
- When the Intelligent Key is placed near an electric appliance such as a personal computer.
- When the vehicle is parked near a parking meter.

In such cases, correct the operating conditions before using the Intelligent Key function or use the mechanical key.

Although the life of the battery varies depending on the operating conditions, the battery's life is approximately 2 years. If the battery is discharged, replace it with a new one.

For information regarding replacement of a battery, see "Intelligent Key battery" (P.8-20).

Since the Intelligent Key is continuously receiving radio waves, if the key is left near equipment which transmits strong radio waves, such as signals from a TV and personal computer, the battery life may become shorter.

Because the steering wheel is locked electrically, unlocking the steering wheel with the ignition switch in the "LOCK" position is impossible when the vehicle battery is completely discharged. Pay special attention that the vehicle battery is not completely discharged.

As many as 4 Intelligent Keys can be used with one vehicle. For information about the purchase and use of additional Intelligent Keys, contact a NISSAN dealer.

CAUTION:

- **Do not allow the Intelligent Key, which contains electrical components, to come into contact with water or salt water. This could affect the system function.**
- **Do not drop the Intelligent Key.**
- **Do not strike the Intelligent Key sharply against another object.**
- **Do not change or modify the Intelligent Key.**
- **Wetting may damage the Intelligent Key. If the Intelligent Key gets wet, immediately wipe until it is completely dry.**
- **If the outside temperature is below -10°C (14°F), the battery of the Intelligent Key may not function properly.**
- **Do not place the Intelligent Key for an extended period in an area where temperatures exceed 60°C (140°F).**
- **Do not attach the Intelligent Key with a key holder that contains a magnet.**

- **Do not place the Intelligent Key near equipment that produces a magnetic field, such as a TV, audio equipment and personal computers.**

If an Intelligent Key is lost or stolen, NISSAN recommends erasing the ID code of that Intelligent Key from the vehicle. This may prevent the unauthorized use of the Intelligent Key to operate the vehicle. For information regarding the erasing procedure, contact a NISSAN dealer.

The Intelligent Key function can be disabled. For information about disabling the Intelligent Key function, contact a NISSAN dealer.

OPERATING RANGE

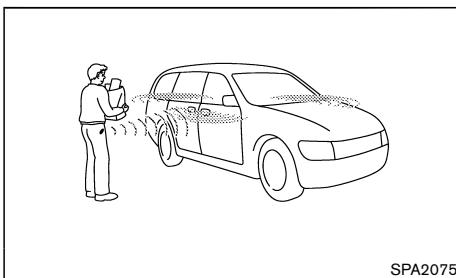
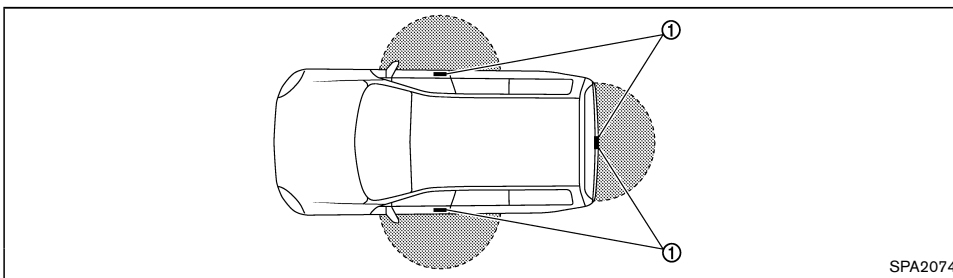

The Intelligent Key functions can only be used when the Intelligent Key is within the specified operating range from the request switch ①.

When the Intelligent Key battery is discharged or strong radio waves are present near the operating location, the Intelligent Key system's operating range becomes narrower, and the Intelligent Key may not function properly.

The operating range is within 80 cm (31.50 in) from each request switch ①.

If the Intelligent Key is too close to the door glass,

handle or rear bumper the request switches may not function.

When the Intelligent Key is within the operating range, it is possible for anyone, even someone who does not carry the Intelligent Key, to push the request switch and lock/unlock the doors.

USING INTELLIGENT KEY SYSTEM

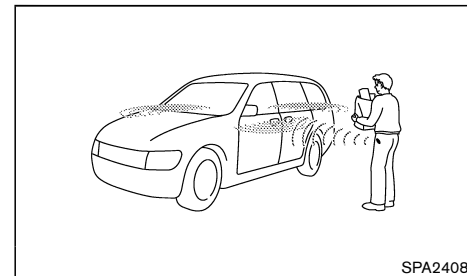

The request switch will not function under the following conditions:

- When the Intelligent Key is left inside the vehicle
- When the Intelligent Key is not within the operational range
- When any door is open or not closed securely
- When the Intelligent Key battery is discharged
- When the ignition switch is in the “ACC” or “ON” position

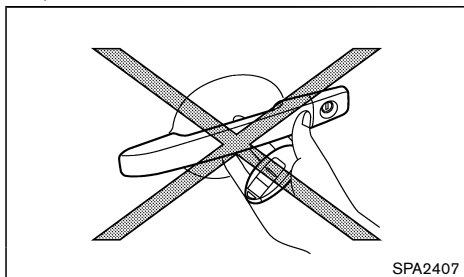

- Do not push the door handle request switch with the Intelligent Key held in your hand as illustrated. The close distance to the door handle will cause the Intelligent Key system to have difficulty recognizing that the Intelligent Key is outside the vehicle.
- After locking the doors using the door handle request switch, make sure that the doors have been securely locked by operating the door handles.
- When locking the doors using the door handle request switch, make sure to have the Intelligent Key in your possession before operating the door handle request switch to prevent the Intelligent Key from being left in the vehicle.
- The door handle request switch is operational only when the Intelligent Key has been detected by the Intelligent Key system.

- Do not pull the door handle before pushing the door handle request switch. The door will be unlocked but will not open. Release the door handle once and pull it again to open the door.

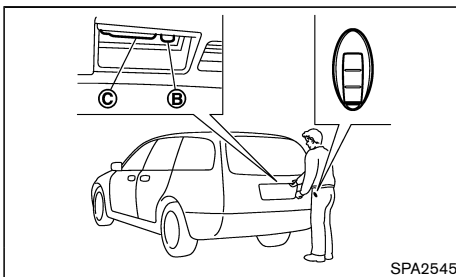
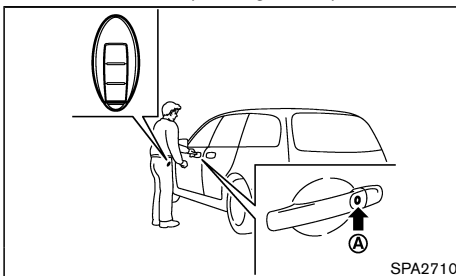

When you carry the Intelligent Key with you, you can lock or unlock all doors by pushing the door handle request switch (driver's or front passenger's) **(A)** or back door request switch **(B)** within the range of operation.

When you lock or unlock the doors or open the back door, the hazard indicator will flash and the outside chime will sound as a confirmation. For details, see “Hazard indicator and outside chime operation” (P.3-

13).

Locking doors

1. Push the ignition switch to the “OFF” position.
2. Carry the Intelligent Key with you.
3. Close all doors.
4. Push the door handle request switch (driver's or front passenger's) **(A)** or the back door request switch **(B)**.
5. All doors and the back door will be locked.
6. Operate door handles to confirm that the doors have been securely locked.

Lockout protection:

To prevent the Intelligent Key from being accidentally locked in the vehicle, lockout protection is equipped with the Intelligent Key system.

- When the Intelligent Key is left in the vehicle and you try to lock the door using the driver's inside lock knob after getting out of the vehicle, all the doors will unlock automatically and a chime will sound after the door is closed.
- When the driver's side door is open and the Intelligent Key is inside the vehicle (including luggage room), the doors cannot be locked using the power door lock switch.



CAUTION:



The lockout protection may not function under the following conditions:

- **When the Intelligent Key is placed on top of the instrument panel.**
- **When the Intelligent Key is placed on the cargo cover.**

- **When the Intelligent Key is placed inside of the glove box.**
- **When the Intelligent Key is placed inside of the door pockets.**
- **When the Intelligent Key is placed inside or near metallic materials.**

The lockout protection may function when the Intelligent Key is outside the vehicle but is too close to the vehicle.

Unlocking doors

1. Carry the Intelligent Key with you.
2. Push the door handle request switch (driver's or front passenger's)  or back door request switch .
3. All doors and the back door will be unlocked.

If a door handle is pulled while unlocking the doors, that door may not be unlocked. Returning the door handle to its original position will unlock the door. If the door does not unlock, after returning the door handle, push the door handle request switch to unlock the door.

Automatic relock:

All doors will be locked automatically unless one of the following operations is performed within 30 seconds after pushing the request switch while the doors are locked.

- Opening any doors.
- Pushing the ignition switch.

If during the preset time period the "UNLOCK"  button on the Intelligent Key is pushed, all doors will be locked automatically after the next preset time.

Opening back door

1. Carry the Intelligent Key.
2. Push the back door opener switch .
3. The back door will unlock and open.

BATTERY SAVER SYSTEM

When all the following conditions are met for a period of time, the battery saver system will cut off the power supply to prevent battery discharge.

- The ignition switch is in the "ACC" position, and
- All doors are closed, and
- The shift lever is in the "P" (Park) position (Continuously Variable Transmission models).

WARNING AND AUDIBLE REMINDERS

The Intelligent Key system is equipped with a function that is designed to minimize improper operations of the Intelligent Key and to help prevent the vehicle from being stolen. A chime or beep sounds inside and outside the vehicle and a warning light illuminates or blinks.

See the troubleshooting guide on the next page and "Warning/indicator lights and audible reminders" (P.2-11).

Intelligent Key system warning light: 

P position selecting warning light:  (Continuously Variable Transmission models)



CAUTION:

When the chime or beep sounds or the warning light illuminates or blinks, be sure to check both the vehicle and the Intelligent Key.

TROUBLESHOOTING GUIDE

Symptom		Possible cause	Action to take
When pushing the ignition switch to stop the engine	The P position selecting warning light in the meter illuminates and the inside warning chime sounds for a few seconds (Continuously Variable Transmission models).	The shift lever is not in the "P" (Park) position.	Shift the shift lever to the "P" (Park) position.
When shifting the shift lever to the P (Park) position (Continuously Variable Transmission models).	The inside warning chime sounds for a few seconds.	The ignition switch is in the "ACC" or "ON" position.	Push the ignition switch to the "OFF" position.
When opening the driver's door to get out of the vehicle	The inside warning chime sounds continuously.	The ignition switch is in the "ACC" position.	Push the ignition switch to the "OFF" position.
When closing the door after getting out of the vehicle	The Intelligent Key system warning light in the meter blinks in yellow, the outside chime sounds 3 times and the inside warning chime sounds for a few seconds.	The ignition switch is in the "ACC" or "ON" position.	Push the ignition switch to the "OFF" position.
	The P position selecting warning light in the meter illuminates and the outside chime sounds continuously (Continuously Variable Transmission models).	The ignition switch is in the "ACC" or "OFF" position and the shift lever is not in the "P" (Park) position.	Move the shift lever to the "P" (Park) position and push the ignition switch to the "OFF" position.
When pushing the request switch or the "LOCK"  button on the Intelligent Key to lock the door	The outside chime sounds for a few seconds and all the doors unlock.	The Intelligent Key is inside the vehicle or luggage room.	Carry the Intelligent Key with you.
When closing the door with the inside lock knob turned to "LOCK"	The outside chime sounds for a few seconds and all the doors unlock.	The Intelligent Key is inside the vehicle or luggage room.	Carry the Intelligent Key with you.
When pushing the door handle request switch to lock the door	The outside chime sounds for a few seconds.	The Intelligent Key is inside the vehicle or luggage room.	Carry the Intelligent Key with you.
		A door is not closed securely.	Close the door securely.
When pushing the ignition switch to start the engine	The Intelligent Key system warning light in the meter blinks in green.	The battery charge is low.	Replace the battery with a new one. (See "Intelligent Key battery" (P.8-20).)
	The Intelligent Key system warning light in the meter blinks in yellow and the inside warning chime sounds for a few seconds.	The Intelligent Key is not in the vehicle.	Carry the Intelligent Key with you.

Symptom	Possible cause	Action to take
When pushing the ignition switch The Intelligent Key system warning light in the meter illuminates in yellow.	It warns of a malfunction with the electrical steering lock system or the Intelligent Key system.	Contact a NISSAN dealer.

USING REMOTE KEYLESS ENTRY FUNCTION

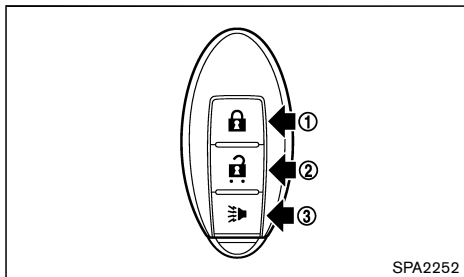

- ① LOCK button
- ② UNLOCK button
- ③ PANIC button

Operating range

It is possible to lock/unlock all doors including the back door using the remote keyless entry system and provides the panic alarm. The operating distance depends upon the conditions around the vehicle. To securely operate the lock and unlock buttons, approach the vehicle to about 1 m (3.3 ft) from the door.

The remote keyless entry system will not function under the following conditions:

- When the Intelligent Key is not within the operational range.

- When the Intelligent Key battery is discharged. For information regarding the replacement of a battery, see "Intelligent Key battery" (P.8-20).

Locking doors

When you lock or unlock the doors, the hazard indicator will flash and the outside chime will sound as a confirmation.

- Place the ignition switch in the "OFF" position and carry the Intelligent Key.
- Close all doors (including the back door).
- Push the "LOCK" button ① on the Intelligent Key.
- All doors will be locked.
- Operate the door handles to confirm that the doors have been securely locked.



CAUTION:

After locking the doors using the Intelligent Key, be sure that the doors have been securely locked by operating the door handles.

Unlocking doors

- Push the "UNLOCK" button ② on the Intelligent Key.
- All doors (including the back door) will be unlocked.

Automatic relock:

All doors will be locked automatically unless one of the following operations is performed within 30 seconds after pushing the "UNLOCK" button ② on the Intelligent Key while the doors are locked. If during this 30-second time period, the "UNLOCK" button ② on the Intelligent Key is pushed, all doors will be locked automatically after another 30 seconds.

- Opening any door or back door.
- Pushing the ignition switch.

Using panic alarm



If you are near your vehicle and feel threatened, you may activate the alarm to call attention as follows:

- Push the "PANIC" button ③ on the Intelligent Key for **more than 1 second**.
- The theft warning alarm will stay on for 25 seconds.
- The panic alarm stops when:
 - It has run for 25 seconds, or
 - Any of the buttons on the Intelligent Key are pushed. (Note: PANIC button should be pushed for more than 1 second.)

HAZARD INDICATOR AND OUTSIDE CHIME OPERATION

When you lock or unlock the doors or the back door with the request switch or the remote keyless entry function, the hazard indicator will flash and the outside chime will sound as a confirmation.

The following descriptions show how the hazard indicator and outside chime will activate when locking or unlocking the doors or back door.

Operation	DOOR LOCK	DOOR UNLOCK
Intelligent Key system (using door handle or back door request switch)	HAZARD - once OUTSIDE CHIME - once	HAZARD - twice OUTSIDE CHIME - twice
Remote keyless entry system (using  or  button)	HAZARD - once OUTSIDE CHIME - once	HAZARD - twice OUTSIDE CHIME - twice

SECURITY SYSTEM (if equipped)

Your vehicle is equipped with NISSAN Anti-theft System (NATS)*.

The security condition will be shown by the security indicator light.

(* immobilizer)

NISSAN ANTI-THEFT SYSTEM (NATS)

The NISSAN Anti-Theft System (NATS) will not allow the engine to start without the use of the registered NATS key.

If the engine does not start using the registered NATS key, it may be due to interference caused by:

- Another NATS key.
- Automated toll road device.
- Automated payment device.
- Other devices that transmit similar signals.

Start the engine using the following procedure:

1. Remove any items that may be causing the interference away from the NATS key.
2. Leave the ignition switch in the "ON" position for approximately 5 seconds.
3. Place the ignition switch in the "OFF" or "LOCK" position, and wait approximately 10 seconds.
4. Repeat steps 2 and 3 again.
5. Start the engine.
6. Repeat the steps above until all possible interferences are eliminated.

If this procedure allows the engine to start, NISSAN recommends placing the registered NATS key separate from other devices to avoid interference.

Security indicator light

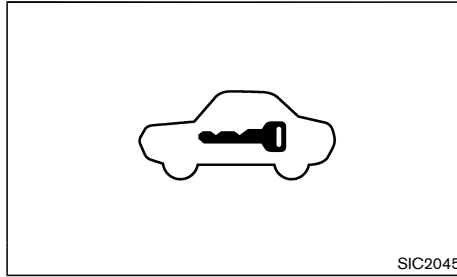

The security indicator light is located on the meter panel. It indicates the status of NATS.

The light operates whenever the ignition switch is in the "LOCK", "OFF" or "ACC" position. The security indicator light indicates that the security systems on the vehicle are operational.

If NATS is malfunctioning, this light will remain on while the ignition switch is in the "ON" position.

If the light remains on and/or the engine does not start, contact a NISSAN dealer for NATS service as soon as possible. Be sure to bring all NATS keys that you have when visiting a NISSAN dealer for service.

HOOD



WARNING:

- The hood must be closed and latched securely before driving. Failure to do so could cause the hood to fly open and result in an accident.
- Never open the hood if steam or smoke is coming from the engine compartment to avoid injury.

OPENING HOOD

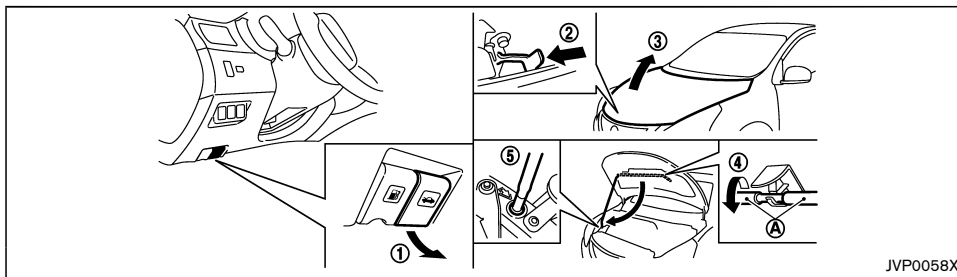

1. Pull the hood lock release handle ① located below the instrument panel until the hood springs up.
2. Locate the lever ② in between the hood and push the lever sideways with your fingertips.
3. Raise the hood ③.
4. Remove the support rod ④ and insert it into the slot ⑤.

Hold the coated parts ④ when removing or resetting the support rod. Avoid direct contact with the metal parts, as they may be hot immediately after the engine has been stopped.

CLOSING HOOD

1. While supporting the hood, return the support rod to its original position.
2. Slowly lower the hood to about 20 to 30 cm (8 to 12 in) above the hood lock, then let it drop.
3. Make sure it is securely latched.



CAUTION:

Before closing the hood, be sure to release the support rod and store it in position. Otherwise, the support rod will be damaged.

BACK DOOR



WARNING:

- Make sure the back door has been closed securely to prevent it from opening while driving.
- Do not drive with the back door open. This could allow dangerous exhaust gases to be drawn into the vehicle.



CAUTION:

- Before opening the back door, be sure to clear away snow, ice or dust that may be stuck to the back door. If the back door is opened while materials are still stuck to it, it may suddenly close again due to the weight of these materials.
- Always be sure to fully open the back door. If it is not fully opened, it may suddenly shut.
- Be especially careful when opening the back door in strong wind. The door could be caught by a gust of wind and may close suddenly.

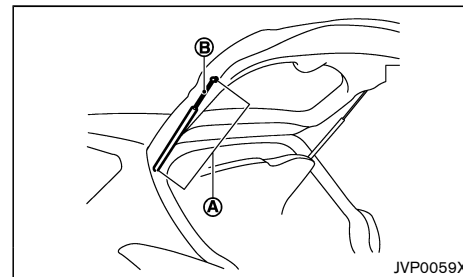

CAUTION:

- The back door gas stays (A) are installed in order to support the weight of the back door. In order to prevent the gas stays being damaged or not operating properly, be sure to observe the following points.
 - Do not insert hands or cords into the gas stays (A) or apply any force to them laterally.
 - Do not attach any adhesive foreign materials such as pieces of plastic or stickers to the rod (B) portion.
- Do not close the back door while holding the gas stays or hang anything on them. Doing so may lead to hands or arms becoming trapped in the back door and could result in an injury.

OPENING BACK DOOR

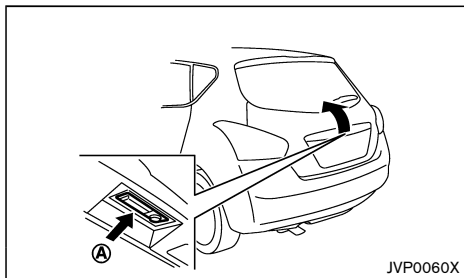

To open the back door, unlock it and push the back door opener switch (A). Pull up the back door to open.

The back door can be unlocked by:

- Push the back door request switch (if equipped). (See "Intelligent Key system" (P.3-7).)
- Push the "UNLOCK" button on the Intelligent Key (if equipped). (See "Intelligent Key system" (P.3-7).)
- Push the "UNLOCK" button on the remote controller (if equipped). (See "Remote keyless entry system" (P.3-5).)
- Push the power door lock switch to the "UNLOCK" position.

CLOSING BACK DOOR

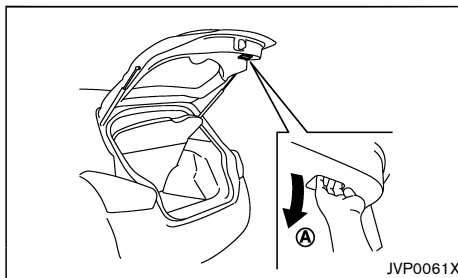

WARNING:

- Do not shut the back door with one hand and the other hand remaining on the back door or vehicle body. Doing so may lead to your hand becoming trapped and could result in an injury.
- When closing the back door, do not place your hands near the edge of the back door. Always be sure to close the back door from the outside.

- After closing the back door, be sure to check that it has been closed securely. If the back door opens while the vehicle is being driven, this could result in a serious accident.

To close the back door, hold the door grip (A) to pull down the door and then push it down securely.

BACK DOOR RELEASE LEVER

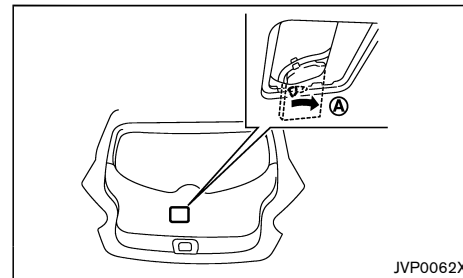

If the back door cannot be unlocked due to a discharged battery, follow these steps.

1. Remove the cover inside of the back door with a suitable tool.
2. Move the lever toward the direction (A) as illustrated to open the back door.

Contact a NISSAN dealer as soon as possible for repair.

FUEL FILLER LID

WARNING:

- Fuel is extremely flammable and highly explosive under certain conditions. You could be burned or seriously injured if it is misused or mishandled. Always stop the engine and do not smoke or allow open flames or sparks near the vehicle when refueling.
- Fuel may be under pressure. Turn the cap a half of a turn, and wait for any "hissing" sound to stop to prevent fuel from spraying out and possibly causing personal injury. Then remove the cap.
- Use only an original equipment type fuel filler cap as a replacement. It has a built-in safety valve needed for proper operation of the fuel system and emission control system. An incorrect cap can result in a serious malfunction and possible injury.

OPENING FUEL FILLER LID

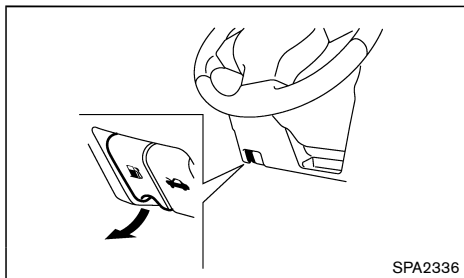

To open the fuel filler lid, pull the fuel filler lid release handle.

FUEL FILLER CAP

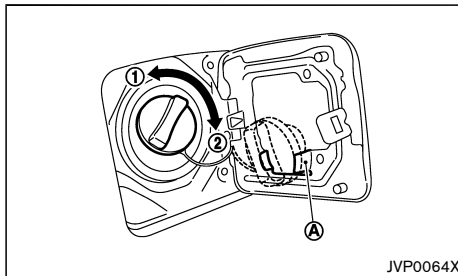

The fuel filler cap is a ratcheting type. Turn the cap counterclockwise ① to remove. Tighten the cap clockwise ② until ratchet clicks, more than twice, after refueling.

Put the fuel filler cap on the cap holder ① while refueling.

CAUTION:

If fuel is spilled on the vehicle body, flush it away with water to avoid paint damage.

STEERING WHEEL

WARNING:

Never adjust the steering wheel while driving so that full attention may be given to vehicle operation.

TILT OR TELESCOPIC OPERATION

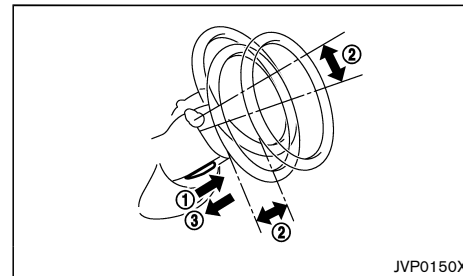

While pulling the lock lever up ①, adjust the steering wheel up, down, forward or rearward ② until the desired position is achieved.

Push the lock lever down ③ firmly to lock the steering wheel in place.

MIRRORS



WARNING:

Adjust the position of all mirrors before driving. Do not adjust the mirror positions while driving so that full attention may be given to vehicle operation.

INSIDE REARVIEW MIRROR

While holding the inside rearview mirror, adjust the mirror angles until the desired position is achieved.

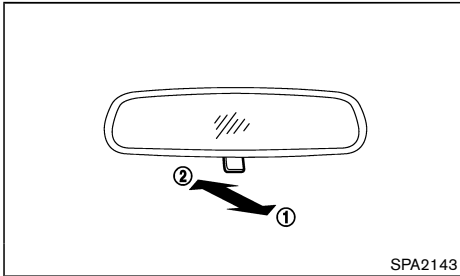

Pull the adjusting lever ① when the glare from the headlights of the vehicle behind you obstructs your vision at night.

Push the adjusting lever ② during the day for the best rearward visibility.

OUTSIDE REARVIEW MIRRORS



WARNING:

- Never touch the outside rearview mirrors while they are in motion. Doing so may pinch your fingers or damage the mirror.
- Never drive the vehicle with the outside rearview mirrors folded. This reduces rear view visibility and may lead to an accident.
- Objects viewed in the outside mirror are closer than they appear (if equipped).
- The picture dimensions and distance in the outside mirrors are not real.

Adjusting

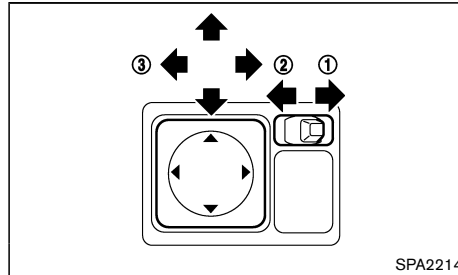

The outside rearview mirror remote control operates when the ignition switch is in the "ACC" or "ON" position.

1. Move the switch to select the right ① or left ② mirror.
2. Adjust each mirror by pushing the switch until the desired position is achieved ③.

Folding

Remote control type:

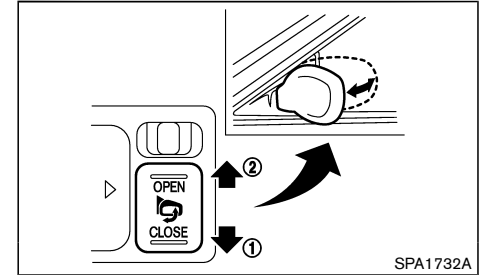

The outside rearview mirror remote control operates when the ignition switch is in the "ACC" or "ON" position.

The outside rearview mirrors automatically fold when the outside rearview mirror folding switch is pushed to the "CLOSE" position ①. To unfold, push to the "OPEN" position ②.



CAUTION:

- Continuously performing the fold/unfold operation of the outside rearview mirror may cause the switch to stop the operation.
- Do not touch the mirrors while they are moving. Your hand may be pinched, and the mirror may malfunction.
- Do not drive with the mirrors stored. You will be unable to see behind the vehicle.
- If the mirrors were folded or unfolded by hand, there is a chance that the mirror will move forward or backward during driving. If the mirrors were folded or unfolded by hand,

be sure to adjust them again electrically before driving.

Manual control type:

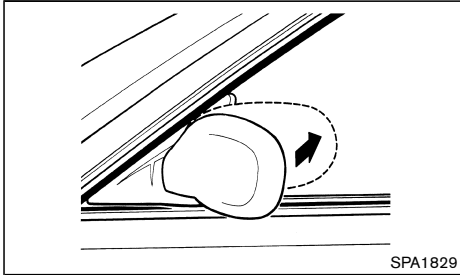

Fold the outside rearview mirror by pushing it toward the rear of the vehicle.

VANITY MIRROR (if equipped)

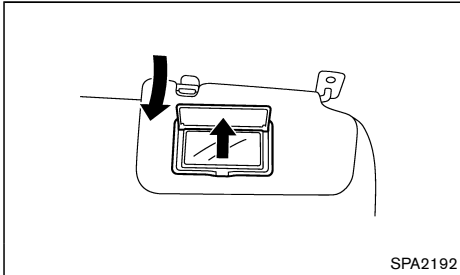

To use the front vanity mirror, pull down the sun visor and pull up the cover.

PARKING BRAKE



WARNING:

- Never drive the vehicle with the parking brake applied. The brake will overheat and fail to operate and will lead to an accident.
- Never release the parking brake from outside the vehicle. If the vehicle moves, it will be impossible to push the foot brake pedal and will lead to an accident.
- Never use the shift lever in place of the parking brake. When parking, be sure the parking brake is fully applied.
- Never leave children or adults who would normally require the support of others alone in your vehicle. They could unknowingly release the parking brake and inadvertently become involved in a serious accident.

turned off.

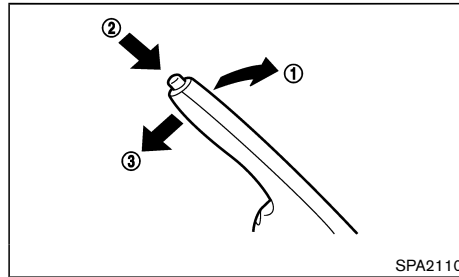

To apply the parking brake, pull the parking brake lever up ①.

To release the parking brake, firmly depress and hold the foot brake pedal. Pull up the parking brake lever slightly, push the button ② and lower the lever completely ③.

Before driving, be sure that the brake warning light has

MEMO

4 Heater and air conditioner, and audio system

Safety precautions	4-2	Audio system	4-11
Rearview Monitor (if equipped)	4-2	Audio operation precautions	4-11
How to read the displayed lines	4-2	Antenna	4-18
Difference between predictive and actual distances	4-3	FM-AM radio with Compact Disc (CD) player	4-19
How to adjust the screen	4-4	FM-AM radio with Compact Disc (CD) player (with color display)	4-22
Notes	4-4	CD/USB memory care and cleaning	4-27
Ventilators	4-5	Audio control steering switch (if equipped)	4-28
Center ventilators	4-5	USB/AUX connector (models with navigation system)	4-28
Side ventilators	4-5	Car phone or CB radio	4-29
Rear ventilators (if equipped)	4-5	Bluetooth® Hands-Free Phone System (if equipped)	4-29
Heater and air conditioner	4-6	Regulatory information	4-30
Operating tips (for automatic air conditioner)	4-6	Using the system	4-30
Manual air conditioner	4-7		
Automatic air conditioner	4-9		
Servicing air conditioner	4-10		

SAFETY PRECAUTIONS



WARNING:

- Do not adjust the heater and air conditioner controls or audio controls while driving so that full attention may be given to vehicle operation.
- If you noticed any foreign objects entering the system hardware, spilled liquid on the system, or noticed smoke or fumes coming out from the system, or any other unusual operation is observed, stop using the system immediately and contact the nearest NISSAN dealer. Ignoring such conditions may lead to an accident, fire or electric shock.
- Do not disassemble or modify this system. If you do, it may lead to an accident, fire, or electric shock.



CAUTION:

Do not use the system when the engine is not running for extended periods of time to prevent battery discharge.

REARVIEW MONITOR (if equipped)

When the shift lever is shifted into the "R" (Reverse) position, the monitor display shows a rearward view from the vehicle.

The system is designed as an aid to the driver in situations such as slot parking or parallel parking.

Designs and items displayed on the screen may vary depending on the models.



WARNING:

- The Rearview Monitor is a convenience but it is not a substitute to check behind the vehicle when backing up. The driver is always responsible for safety during parking and other manoeuvres.
- Objects viewed in the Rearview Monitor differ from actual distance because a wide-angle lens is used. Objects in the Rearview Monitor will appear visually opposite like ones viewed in the inside and outside mirrors.
- Make sure that the back door is securely closed when backing up.
- Underneath the bumper and the corner areas of the bumper cannot be viewed on the Rearview Monitor because of its monitoring range limitation.
- Do not put anything on the Rearview camera.
- The Rearview camera is installed above the license plate.
- When washing the vehicle with high-pressure water, be sure not to spray it around the camera. Otherwise, water may enter the camera unit causing water condensation on the lens, a malfunction, fire or an electric

shock.

- Do not strike the camera. It is a precision instrument. Otherwise, it may malfunction or cause damage resulting in a fire or an electric shock.



CAUTION:

Do not scratch the camera lens when cleaning dirt or snow from the lens.

HOW TO READ THE DISPLAYED LINES

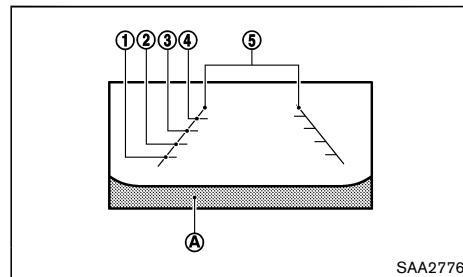

Guide lines which indicate the vehicle width and distances to objects with reference to the bumper line (A) are displayed on the monitor.

Distance guide lines:

Indicate distances from the vehicle body.

- Red line (1) : approx. 0.5 m (1.5 ft)
- Yellow line (2) : approx. 1 m (3 ft)
- Green line (3) : approx. 2 m (7 ft)
- Green line (4) : approx. 3 m (10 ft)

Vehicle width guide lines ⑤ :

Indicate the vehicle width when backing up.

NOTE:

For models with navigation system, the guide lines can be turned on and off by pushing the CAMERA button.

DIFFERENCE BETWEEN PREDICTIVE AND ACTUAL DISTANCES

Backing up on a steep uphill

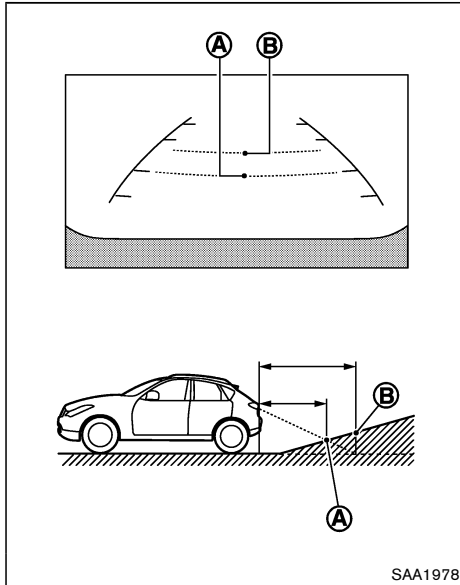

When backing up the vehicle up a hill, the distance

guide lines and the vehicle width guide lines are shown closer than the actual distance. For example, the display shows 1 m (3 ft) to the place ①, but the actual 1 m (3 ft) distance on the hill is the place ②. Note that any object on the hill is viewed in the monitor further than it appears.

Backing up on a steep downhill

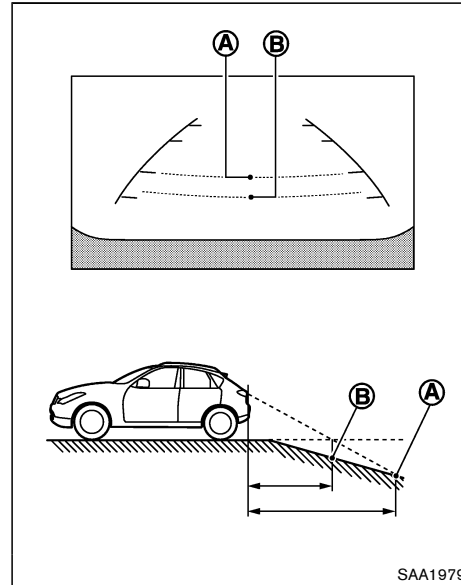

When backing up the vehicle down a hill, the distance guide lines and the vehicle width guide lines are shown further than the actual distance. For example, the display shows 1 m (3 ft) to the place ①, but the actual 1 m (3 ft) distance on the hill is the place ②.

Note that any object on the hill is viewed in the monitor closer than it appears.

Backing up near a projecting object

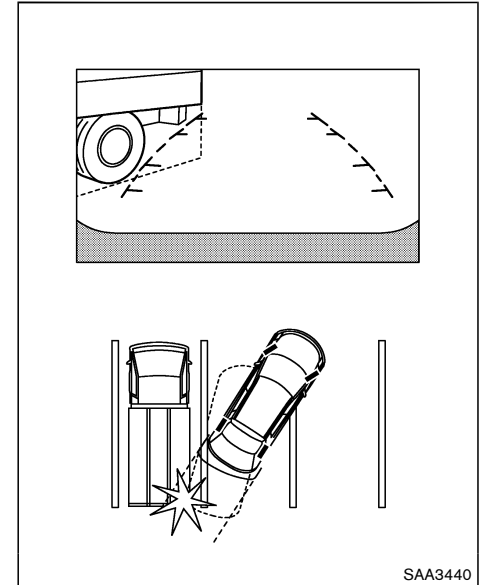

The vehicle may seem to nearly clear the object in the display. However, the vehicle may hit the object if it projects over the actual backing up course.

Backing up behind a projecting object

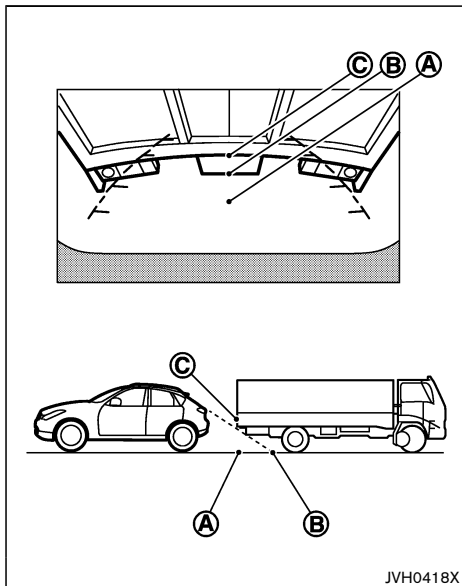

The position ③ is shown further than the position ② in the display. However, the position ③ is actually at the same distance as the position ①. The vehicle may hit the object when backing up to the position ① if the object projects over the actual backing up course.

HOW TO ADJUST THE SCREEN

Models with navigation system:

Guide lines:

Guide line display can be turned on and off by pushing the CAMERA button.

Display adjustments:

For operations to adjust the screen display settings including brightness, language, etc., see the separately provided NISSAN Connect Owner's Manual.

Models without navigation system:

Brightness, Contrast and Language of the messages on the Rearview Monitor screen can be adjusted.

1. Push the ENTER/SETTING button while the Rearview Monitor screen is displayed. Each time the ENTER/SETTING button is pushed, the next setting item is selected.
2. Turn the TUNE-FOLDER control knob to adjust the setting of the item.
3. Push the ENTER/SETTING button to complete the setting adjustment.
4. Push ENTER/SETTING button again to select the next setting item.

Setting adjustment mode will end if the ENTER/SETTING button is pushed while the last setting item is selected, if the BACK button is pushed or if the screen is left without operation for some time.

NOTES

- When the view is switched, the display images on the screen may be displayed with some delay.
- When the temperature is extremely high or low, the screen may not clearly display objects. This is not a malfunction.
- When strong light is directly coming on the camera, objects may not be displayed clearly. This is not a malfunction.
- Vertical lines may be seen in objects on the screen. This is due to strong reflected light from the bumper. This is not a malfunction.
- The screen may flicker under fluorescent light. This is not a malfunction.
- The colors of objects on the Rearview Monitor may differ somewhat from the actual color of objects. This is not a malfunction.
- Objects on the monitor may not be clear in a dark environment. This is not a malfunction.
- If dirt, rain or snow accumulates on the camera, the Rearview Monitor may not display objects clearly. Clean the camera.
- Do not use alcohol, benzine or thinner to clean the camera. This will cause discoloration. To clean the camera, wipe with a cloth dampened with diluted mild cleaning agent and then wipe with a dry cloth.
- Do not damage the camera as the monitor screen may be adversely affected.
- Do not use wax on the camera window. Wipe off any wax with a clean cloth dampened with mild detergent diluted with water.

VENTILATORS

CENTER VENTILATORS

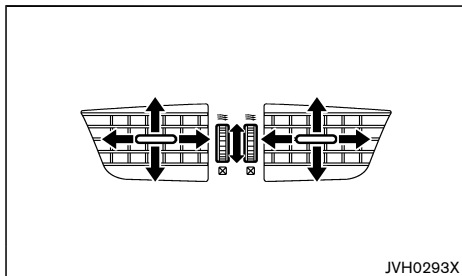

Open/close the ventilators by moving the control in either direction.

- ☒ : This symbol indicates that the ventilators are closed. Moving the side control in this direction will close the ventilators.
- ≡ : This symbol indicates that the ventilators are open. Moving the side control in this direction will open the ventilators.

Adjust the air flow direction of the ventilators by moving the center knob (up/down, left/right) until the preferred position is achieved.

SIDE VENTILATORS

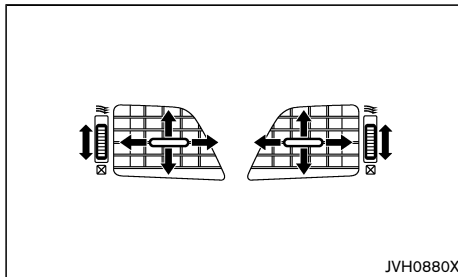

Open/close the ventilators by moving the control in either direction.

- ☒ : This symbol indicates that the ventilators are closed. Moving the side control in this direction will close the ventilators.
- ≡ : This symbol indicates that the ventilators are open. Moving the side control in this direction will open the ventilators.

Adjust the air flow direction of the ventilators by moving the center knob (up/down, left/right) until the preferred position is achieved.

REAR VENTILATORS (if equipped)

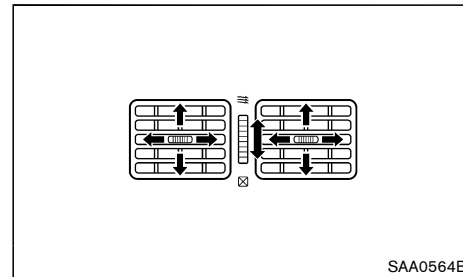

Open/close the ventilators by moving the control to either direction.

- ☒ : This symbol indicates that the ventilators are closed. Moving the side control to this direction will close the ventilators.
- ≡ : This symbol indicates that the ventilators are open. Moving the side control to this direction will open the ventilators.

Adjust the air flow direction of the ventilators by moving the center knob (up/down, left/right) until the desired position is achieved.

HEATER AND AIR CONDITIONER



WARNING:

- Never leave children or adults who would normally require the support of others alone in the vehicle. Pets should not be left alone either. They could unknowingly activate switches or controls and inadvertently become involved in a serious accident and injure themselves. On hot, sunny days, temperatures in a closed vehicle could quickly become high enough to cause severe or possibly fatal injuries to people or animals.
- Do not use the recirculation mode for long periods as it may cause the interior air to become stale and the windows to fog up.
- Do not adjust the heating and air conditioning controls while driving so that full attention may be given to vehicle operation.

The heater and air conditioner operate when the engine is running. The air blower will operate even if the engine is turned off and the ignition switch is in the "ON" position.

NOTE:

- Odors from inside and outside the vehicle can build up in the air conditioner unit. Odor can enter the passenger compartment through the vents.
- When parking, set the heater and air conditioner controls to turn off air recirculation to allow fresh air into the passenger compartment. This should help reduce odors inside the vehicle.

OPERATING TIPS (for automatic air conditioner)

put anything on or around the sensors.

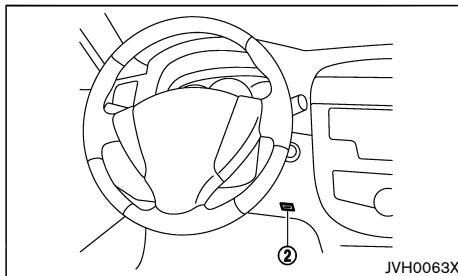
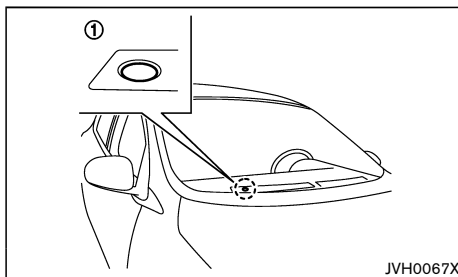

Left-Hand Drive (LHD) model*





*: The illustration is for the Left-Hand Drive (LHD) model. For the Right-Hand Drive (RHD) model, the layout will be the opposite.

When the engine coolant temperature and outside air temperature are low, the air flow from the foot outlets may not operate. However, this is not a malfunction. After the coolant temperature warms up, the air flow from the foot outlets will operate normally.

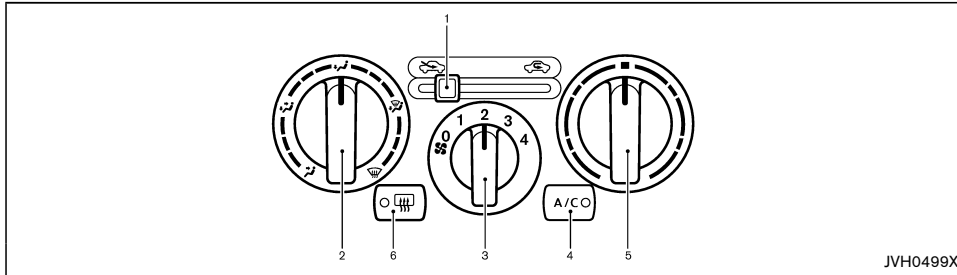
The sensors ① and ②, located on the instrument panel, help maintain a constant temperature. Do not

MANUAL AIR CONDITIONER



1. Air intake lever (Outside air circulation “” /Air recirculation “”)
2. Air flow control dial
3. Fan speed control “” dial
4. “A/C” (Air Conditioner) button
5. Temperature control dial
6. Rear defogger “” button (See “Defogger switch” (P.2-21).)

To turn off the heater and air conditioner, turn the fan speed control “” dial to the “OFF” (0) position.

Controls

Outside air circulation:





Move the air intake lever to the “” position. The air flow is drawn from outside the vehicle.

Air recirculation:

Move the air intake lever to the “” position. The air flow is circulated inside the vehicle.

Air flow control:

Turn the air flow control dial to change the air flow mode.

-  — Air flows from the center and side ventilators.
-  — Air flows from the center and side ventilators and foot outlets.
-  — Air flows mainly from the foot outlets.
-  — Air flows from the front defogger and foot outlets.
-  — Air flows mainly from the front defogger outlets.

Fan speed control:

Turn the fan speed control “” dial clockwise to increase the fan speed.

Turn the fan speed control “” dial counterclockwise to decrease the fan speed.

A/C (Air Conditioner) operation:

Push the “A/C” button to turn on or off the air conditioner. When the air conditioner is on, the “A/C” indicator light on the button illuminates.



Temperature control:

Turn the temperature control dial to set the desired temperature. Turn the dial between the middle and the right position to select the hot temperature. Turn the dial between the middle and the left position to select the cool temperature.

Heater operation



Heating:

This mode is used to direct heated air to the foot outlets.

1. Move the air intake lever to the “” position for normal heating.
2. Turn the air flow control dial to the “” position.
3. Turn the fan speed control “” dial to the desired position.
4. Turn the temperature control dial to the desired position between the middle and the hot (right) position.





Ventilation:

This mode directs outside air to the side and center ventilators.

1. Move the air intake lever to the “” position.
2. Turn the air flow control dial to the “” position.
3. Turn the fan speed control “” dial to the desired position.
4. Turn the temperature control dial to the desired position.



Defrosting or defogging:

This mode directs the air to the defogger outlets to defrost/defog the windows.

1. Move the air intake lever to the “” position.
 2. Turn the air flow control dial to the “” position.
 3. Turn the fan speed control “” dial to the desired position.
 4. Turn the temperature control dial to the desired position between the middle and the hot (right) position.
- To remove frost from the outside surface of the windshield quickly, turn the temperature control dial to the maximum hot position and the fan speed control “” dial to maximum position.
 - If it is difficult to defog the windshield, turn the “A/C” button on.



Bi-level heating:

This mode directs cool air from the side and center ventilators and warm air from the foot outlets. When the temperature control dial is turned to the maximum hot or cool position, the air between the ventilators and the foot outlets is the same temperature.

1. Move the air intake lever to the “” position.
2. Turn the air flow control dial to the “” position.
3. Turn the fan speed control “” dial to the desired position.
4. Turn the temperature control dial to the desired position.

Heating and defogging:

This mode heats the interior and defogs the windows.



1. Move the air intake lever to the “” position.
2. Turn the air flow control dial to the “” position.
3. Turn the fan speed control “” dial to the desired position.
4. Turn the temperature control dial to the maximum hot (right) position.
5. Push the “A/C” button on. (The “A/C” indicator light will illuminate.)

Air conditioner operation

The air conditioner system should be operated for approximately 10 minutes at least once a month. This helps prevent damage to the air conditioner system due to the lack of lubrication.

Cooling:



This mode is used to cool and dehumidify the air.

1. Move the air intake lever to the “” position.
2. Turn the air flow control dial to the “” position.
3. Turn the fan speed control “” dial to the desired position.
4. Push the “A/C” button on. (The “A/C” indicator light will illuminate.)
5. Turn the temperature control dial to the desired position between the middle and the cool (left) position.

A visible mist may be seen coming from the ventilators in hot, humid conditions as the air is cooled rapidly. This does not indicate a malfunction.



Dehumidified heating:

This mode is used to heat and dehumidify the air.

1. Move the air intake lever to the “” position.
2. Turn the air flow control dial to the “” position.
3. Turn the fan speed control “” dial to the desired position.
4. Push the “A/C” button on. (The “A/C” indicator light will illuminate.)
5. Turn the temperature control dial to the desired position between the middle and the hot (right) position.

Dehumidified defogging:

This mode is used to defog the windows and dehumidify the air.

1. Move the air intake lever to the “” position.
2. Turn the air flow control dial to the “” position.
3. Turn the fan speed control “” dial to the desired position.
4. Push the “A/C” button on. (The “A/C” indicator light will illuminate.)
5. Turn the temperature control dial to the desired position.

AUTOMATIC AIR CONDITIONER

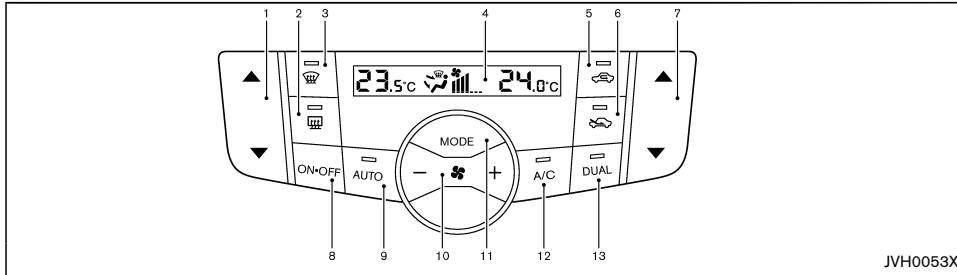

* The switch layout in the illustration is for the Left-Hand Drive (LHD) model. For the Right-Hand Drive (RHD) model, the switch layout will be the opposite.

1. Temperature control buttons (driver side)
2. “” rear defogger button (See “Defogger switch” (P.2-21).)
3. “” front defogger button
4. Display screen
5. “” Air recirculation button
6. “” Outside air circulation button
7. Temperature control buttons (passenger side)
8. “ON-OFF” button
9. “AUTO” button
10. “” fan speed control button
11. “MODE” button
12. “A/C” (Air Conditioner) button
13. “DUAL” zone control ON/OFF button

Automatic operation (AUTO)

The AUTO mode may be used year-round as the system automatically controls the air conditioner to a constant temperature, air flow distribution and fan speed after the desired temperature is set manually.

To turn the heater and air conditioner on or off, push the “ON-OFF” button.

Cooling and dehumidified heating:

1. Push the “AUTO” button (the AUTO indicator light will illuminate).
2. If the A/C indicator light is not illuminated, push the “A/C” button (the A/C indicator light will illuminate).
3. Push the temperature control buttons (“▲” and “▼”) to set the desired temperature.
 - When the DUAL indicator light is not illuminated, pushing the “AUTO” button (the AUTO indicator light will illuminate) changes both the driver and passenger side temperature.
 - When the DUAL indicator light is not illuminated, pushing the “DUAL” button (the DUAL indicator light will illuminate) allows the user to

independently change the driver and passenger side temperatures with the corresponding temperature control buttons (“▲” and “▼”).

- To cancel the separate temperature setting, push the “DUAL” button (the DUAL indicator light will turn off) and the driver’s side temperature setting will be applied to both the driver and passenger sides.
4. Push either the outside air circulation “” button or the air recirculation “” button (the button with an indicator light illuminated) for approximately 2 seconds to switch to the automatic air intake control mode (the indicator light will blink twice).

A visible mist may be seen coming from the ventilators in hot, humid conditions as the air is cooled rapidly. This does not indicate a malfunction.



Heating (A/C off):

1. Push the “AUTO” button (the AUTO indicator light will illuminate).
2. If the “A/C” indicator light is illuminated, push the “A/C” button (the A/C indicator light will turn off).
3. Push the temperature control buttons (“▲” and “▼”) to set the desired temperature.
 - When the DUAL indicator light is not illuminated, pushing the “AUTO” button (the AUTO indicator light will illuminate) changes both the driver and passenger side temperature.
 - When the DUAL indicator light is not illuminated, pushing the “DUAL” button (the DUAL indicator light will illuminate) allows the user to independently change the driver and passenger side temperatures with the corresponding temperature control buttons (“▲” and “▼”).

“ ▼ ”).

- To cancel the separate temperature setting, push the “DUAL” button (the DUAL indicator light will turn off) and the driver’s side temperature setting will be applied to both the driver and passenger sides.
- Do not set the temperature lower than the outside air temperature. Doing so may cause the temperature to not be controlled properly.
- If the windows fog up, use dehumidified heating instead of the A/C off heating.

Dehumidified defrosting/defogging:

1. Push the front defogger “” button (the “” indicator light will illuminate).
 2. Push the temperature control buttons (“ ▲ ” and “ ▼ ”) to set the desired temperature.
- To quickly remove frost from the outside surface of the windshield, set the temperature control and the fan speed to the maximum levels.
 - After the windshield is cleared, push the “AUTO” button again (the AUTO indicator light will turn off).
 - When the front defogger “” button is pushed, the air conditioner will automatically turn on to defog the windshield if the outside temperature is above -2 °C. If the air recirculation mode is turned on at the time, the ventilation will change from the air recirculation mode to the outside air circulation mode to improve the defogging performance.

Do not set the temperature too low when the front defogger mode is on (the “” indicator light is illuminated), because doing so may fog up the windshield.

Manual operation

The manual mode can be used to control the heater and air conditioner to your desired settings.

To turn off the heater and air conditioner, push the “ON-OFF” button.





Fan speed control:

Push the fan speed control “” button (+ side or – side) to manually control the fan speed.

Push the “AUTO” button to change the fan speed to the automatic mode.

Air flow control:

Push the “MODE” button to select the desired mode:

-  — Air flows from the center and side ventilators.
-  — Air flows from the center and side ventilators and foot outlets.
-  — Air flows mainly from the foot outlets
-  — Air flows from the front defogger outlets and foot outlets.

Temperature control:

Push the temperature control buttons (“ ▲ ” and “ ▼ ”) to set the desired temperature.

- When the DUAL indicator light is not illuminated, pushing the “AUTO” button (the AUTO indicator light will illuminate) changes both the driver and passenger side temperature.
- When the DUAL indicator light is not illuminated, pushing the “DUAL” button (the DUAL indicator light will illuminate) allows the user to independently change the driver and passenger side temperatures with the corresponding temperature control buttons (“ ▲ ” and “ ▼ ”).

- To cancel the separate temperature setting, push the “DUAL” button (the DUAL indicator light will turn off) and the driver’s side temperature setting will be applied to both the driver and passenger sides.







Outside air circulation:

Push the outside air circulation button to draw the air flow from outside the vehicle. (The “” indicator light will illuminate.)

Air recirculation:

Push the air recirculation button to circulate the air flow inside the vehicle. (The “” indicator light will illuminate.)

Automatic air intake control:

Push either the outside air circulation “” or the air recirculation “” button (the button with an indicator light illuminated) for approximately 2 seconds. The “” and “” indicator lights will blink twice, and the air intake will then be controlled automatically. When the automatic control is set, the system automatically alternates between the outside air circulation “” and the air recirculation “” modes (the indicator light of the active mode will illuminate).

SERVICING AIR CONDITIONER



WARNING:

The air conditioner system contains refrigerant under high pressure. To avoid personal injury, any air conditioner service should be done only by an experienced technician with the proper equipment.

The air conditioner system in your vehicle is charged with a refrigerant designed with the environment in

AUDIO SYSTEM

mind.

This refrigerant will not harm the earth's ozone layer. However, it may contribute in a small part to global warming.

Special charging equipment and lubricant are required when servicing your vehicle's air conditioner. Using improper refrigerants or lubricants will cause severe damage to the air conditioner system. (See "Air conditioner system refrigerant and lubricant" (P.9-5).)

A NISSAN dealer will be able to service your environmentally friendly air conditioner system.

Air conditioner filter

The air conditioner system is equipped with an air conditioner filter which collects dust. To make sure the air conditioner heats defogs, and ventilates efficiently, replace the filter in accordance with the specified maintenance intervals listed in the separate maintenance booklet. To replace the filter, contact a NISSAN dealer.

The filter should be replaced if the air flow decreases significantly or if windows fog up easily when operating the heater or air conditioner.

AUDIO OPERATION PRECAUTIONS



WARNING:

Do not adjust the audio system while driving so that full attention may be given to vehicle operation.

Radio

- Radio reception is affected by station signal strength, distance from radio transmitter, buildings, bridges, mountains and other external influences. Intermittent changes in reception quality normally are caused by these external influences.
- Using a cellular phone in or near the vehicle may influence radio reception quality.

Compact Disc (CD) player

- During cold weather or rainy days, the player may malfunction due to the humidity. If this occurs, remove the CD from CD player and dehumidify or ventilate the player completely.
- The player may skip while driving on rough roads.
- The CD player sometimes may not function when the passenger compartment temperature is extremely high. Lower the temperature before use.
- Do not expose the CD to direct sunlight.
- CDs that are of poor quality, or are dirty, scratched, covered with fingerprints, or that have pin holes may not work properly.
- The following CDs may not work properly.
 - Copy control compact discs (CCCD)
 - Recordable compact discs (CD-R)
 - Rewritable compact discs (CD-RW)

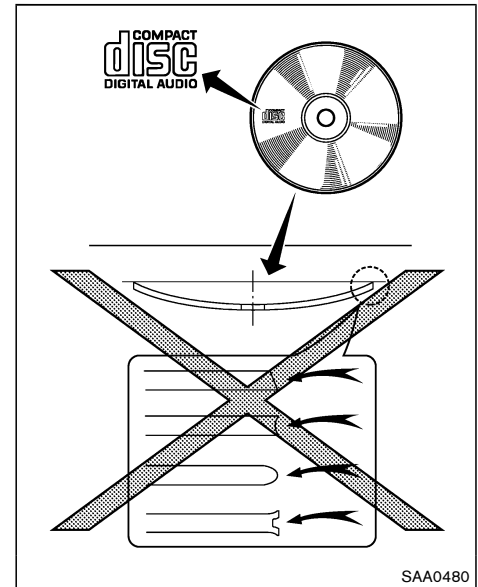

- Do not use the following CDs as they may cause the CD player to malfunction.
 - 8 cm (3.1 in) discs
 - CDs that are not round
 - CDs with a paper label
 - CDs that are warped, scratched or have unusual edges.
 - CD lens cleaner discs
- This audio system can only play prerecorded CDs. It has no capabilities to record or burn CDs.

- If the CD cannot be played, one of the following messages will be displayed.

Error CD:

- Confirm that the CD is inserted correctly (the label side is facing up, etc.).
- Confirm that the CD is not bent or warped and it is free of scratches.
- Confirm that the disc is a CD and not a DVD.
- Confirm that the disc contains audio files.

Eject CD:

This is a malfunction due to the temperature inside the player is too high. Remove the CD by pushing the EJECT button, and after a short time reinsert the CD. The CD can be played when the temperature of the player returns to normal.



WARNING:

Do not adjust the audio system while driving.

The audio system operates when the ignition switch is in the "ACC" or "ON" position. If you want to listen to the radio or CD while the engine is not running, turn the ignition switch to the "ACC" position. **Do not use for an extended period of time with the engine stopped.**

USB (Universal Serial Bus) (if equipped)



WARNING:

Do not connect, disconnect or operate the USB device while driving. Doing so can be a distraction. If distracted you could lose control of your vehicle and cause an accident or serious injury.



CAUTION:

- **Do not force the USB device into the USB port. Inserting the USB device tilted or upside-down into the port may damage the port. Make sure that the USB device is connected correctly into the USB port.**
- **Do not grab the USB port cover (if equipped) when pulling the USB device out of the port. This could damage the port and the cover.**
- **Do not leave the USB cable in a place where it can be pulled unintentionally. Pulling the cable may damage the port.**

The vehicle is not equipped with a USB device. USB devices should be purchased separately as necessary. This system cannot be used to format USB devices. To format a USB device, use a personal computer.

In some states/area, the USB device for the front seats plays only sound without images for regulatory reasons, even when the vehicle is parked.

This system supports various USB memory devices, USB hard drives and iPod players. Some USB devices may not be supported by this system.

- Partitioned USB devices may not be played correctly.
- Some characters used in other languages (Chinese, Japanese, etc.) are not displayed properly on display. Using English language characters with a USB device is recommended.

General notes for USB use:

Refer to your device manufacturer's owner information regarding the proper use and care of the device.

Notes for iPod use:

iPod is a trademark of Apple Inc., registered in the U.S. and other countries.

- Improperly plugging in the iPod may cause a checkmark to be displayed on and off (flickering). Always make sure that the iPod is connected properly.
- An iPod nano (1st Generation) may remain in fast forward or rewind mode if it is connected during a seek operation. In this case, please manually reset the iPod.
- An iPod nano (2nd Generation) will continue to fast-forward or rewind if it is disconnected during a seek operation.
- An incorrect song title may appear when the Play Mode is changed while using an iPod nano (2nd Generation)
- Audiobooks may not play in the same order as they appear on an iPod.
- Large video files cause slow responses in an iPod. The vehicle center display may momentarily black out, but will soon recover.
- If an iPod automatically selects large video files while in the shuffle mode, the vehicle center display may momentarily black out, but will soon recover.

Compact Disc/USB memory with MP3 or WMA (if equipped)

Terms:

- MP3 — MP3 is short for Moving Pictures Experts Group Audio Layer 3. MP3 is the most well known compressed digital audio file format. This format allows for near "CD quality" sound, but at a fraction of the size of normal audio files. MP3 conversion of an audio track from CD can reduce

the file size by approximately 10:1 ratio Sampling: 44.1 kHz, Bit rate: 128 kbps) with virtually no perceptible loss in quality. MP3 compression removes the redundant and irrelevant parts of a sound signal that the human ear doesn't hear.

- **WMA** — Windows Media Audio (WMA)* is a compressed audio format created by Microsoft as an alternative to MP3. The WMA codec offers greater file compression than the MP3 codec, enabling storage of more digital audio tracks in the same amount of space when compared to MP3s at the same level of quality.
- **Bit rate** — Bit rate denotes the number of bits per second used by a digital music files. The size and quality of a compressed digital audio file is determined by the bit rate used when encoding the file.
- **Sampling frequency** — Sampling frequency is the rate at which the samples of a signal are converted from analog to digital (A/D conversion) per second.
- **Multisession** — Multisession is one of the methods for writing data to media. Writing data once to the media is called a single session, and writing more than once is called a multisession.
- **ID3/WMA Tag** — The ID3/WMA tag is the part of the encoded MP3 or WMA file that contains information about the digital music file such as song title, artist, album title, encoding bit rate, track time duration, etc. ID3 tag information is displayed on the Album/Artist/Track title line on the display.

* Windows® and Windows Media® are registered trademarks and/or trademarks of Microsoft Corporation in the United States of America and/or other countries.

Playback order:

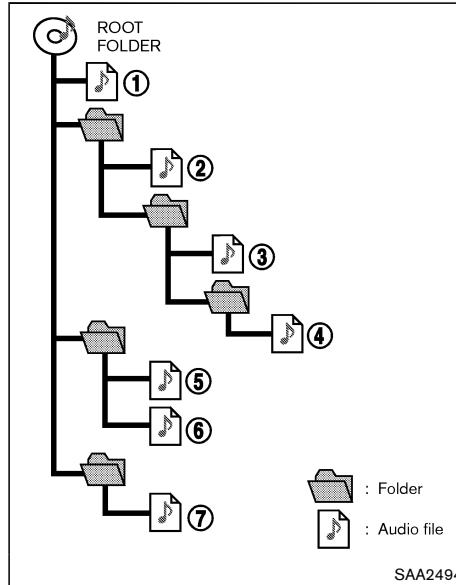

Music playback order of the CD with MP3 or WMA is as illustrated above.

- The names of folders not containing MP3/WMA files are not shown in the display.
- If there is a file in the top level of the disc, "Root" is displayed.
- The playback order is the order in which the files were written by the writing software, so the files might not be played in the desired order.

Specification chart (models without color display):

Supported media		CD, CD-R, CD-RW	
Supported file systems		ISO9660 LEVEL1, ISO9660 LEVEL2, Romeo, Joliet * ISO9660 Level 3 (packet writing) is not supported. * Files saved using the Live File System Component (on a Windows Vista-based computer) are not supported.	
Supported versions*1	MP3	Version	MPEG1, MPEG2, MPEG2.5
		Sampling frequency	8 kHz - 48 kHz
		Bit rate	8 kbps - 320 kbps, VBR*4
	WMA*3	Version	WMA7, WMA8, WMA9 (except WMA9 Pro, WMA9 Lossless, WMA9 Voice)
		Sampling frequency	32 kHz - 48 kHz
		Bit rate	32 kbps - 192 kbps, VBR*4
Tag information (Song title and Artist name)		ID3 tag VER1.0, VER1.1, VER2.2, VER2.3, VER2.4 (MP3 only) WMA tag (WMA only)	
Folder levels		Folder levels: 8, Folders:255 (including root folder), files: 512	
Displayable character codes*2		01: ASCII, 02: ISO-8859-1, 03: UNICODE (UTF-16 BOM Big Endian), 04: UNICODE (UTF-16 Non-BOM Big Endian), 05: UNICODE (UTF-8), 06: UNICODE (Non-UTF-16 BOM Little Endian)	

*1 Files created with a combination of 48 kHz sampling frequency and 64 kbps bit rate cannot be played.

*2 Available codes depend on what kind of media, versions and information are going to be displayed.

*3 Protected WMA files (DRM) cannot be played.

*4 When VBR files are played, the playback time may not be displayed correctly. WMA7 and WMA8 are not applied to VBR.

Specification chart (models with color display):

Supported media		CD, CD-R, CD-RW, USB2.0	
Supported file systems		CD, CD-R, CD-RW: ISO9660 LEVEL1, ISO9660 LEVEL2, Romeo, Joliet * ISO9660 Level 3 (packet writing) is not supported. * Files saved using the Live File System component (on a Windows Vista-based computer) are not supported. USB memory: FAT16, FAT32	
Supported versions*1	MP3	Version	MPEG1 Audio Layer 3
		Sampling frequency	8 kHz - 48 kHz
		Bit rate	8 kbps - 320 kbps, VBR*4
	WMA*2	Version	WMA7, WMA8, WMA9
		Sampling frequency	32 kHz - 48 kHz
		Bit rate	32 kbps - 192 kbps, VBR*4
Tag information (Song title and Artist name)		ID3 tag VER1.0, VER1.1, VER2.2, VER2.3, VER2.4 (MP3 only) WMA tag (WMA only)	
Folder levels	CD, CD-R, CD-RW	Folder levels: 8, Folders and files: 999 (Max. 255 files for one folder)	
	USB	Folder levels: 8, Folders 255, Files: 2500 (Max. 255 files for one folder) Memory size: 4GB	
Displayable character codes*3		01: ASCII, 02: ISO-8859-1, 03: UNICODE (UTF-16 BOM Big Endian), 04: UNICODE (UTF-16 Non-BOM Big Endian), 05: UNICODE (UTF-8), 06: UNICODE (Non-UTF-16 BOM Little Endian), 07: SHIFT-JIS	

*1 Files created with a combination of 48 kHz sampling frequency and 64 kbps bit rate cannot be played.

*2 Protected WMA files (DRM) cannot be played.

*3 Available codes depend on what kind of media, versions and information are going to be displayed.

*4 When VBR files are played, the playback time may not be displayed correctly.

Troubleshooting guide (models without color display):

Symptom	Cause and Countermeasure
Cannot play	Check if the disc was inserted correctly.
	Check if the disc is scratched or dirty.
	Check if there is condensation inside the player, and if there is, wait until the condensation is gone (about 1 hour) before using the player.
	If there is a temperature increase error, the CD player will play correctly after it returns to the normal temperature.
	If there is a mixture of music CD files (CD-DA data) and MP3/WMA/AAC files on a CD, only the music CD files (CD-DA data) will be played.
	Files with extensions other than “.MP3”, “.WMA”, “.mp3” or “.wma” cannot be played. In addition, the character codes and number of characters for folder names and file names should be in compliance with the specifications.
	Check if the disc or the file is generated in an irregular format. This may occur depending on the variation or the setting of MP3/WMA writing applications or other text editing applications.
	Check if the finalisation process, such as session close and disc close, is done for the disc.
Poor sound quality	Check if the disc is scratched or dirty.
It takes a relatively long time before the music starts playing.	If there are many folder or file levels on the MP3/WMA disc, some time may be required before the music starts playing.
Music cuts off or skips	The writing software and hardware combination might not match, or the writing speed, writing depth, writing width, etc., might not match the specifications. Try using the slowest writing speed.
Skipping with high bit rate files	Skipping may occur with large quantities of data, such as for high bit rate data.
Move immediately to the next song when playing.	When a non-MP3/WMA file has been given an extension of “.MP3”, “.WMA”, “.mp3” or “.wma” or when play is prohibited by copyright protection, the player will skip to the next song.
The songs do not play back in the desired order.	The playback order is the order in which the files were written by the writing software, so the files might not play in the desired order.

Troubleshooting guide (model with color display):

Symptom	Cause and Countermeasure
Cannot play	Check if the disc or USB device was inserted correctly.
	Check if the disc is scratched or dirty.
	Check if there is condensation inside the player, and if there is, wait until the condensation is gone (about 1 hour) before using the player.
	If there is a temperature increase error, the player will play correctly after it returns to the normal temperature.
	If there is a mixture of music CD files (CD-DA data) and compressed audio files on a CD, only the music CD files (CD-DA data) will be played.
	Files with extensions other than ".MP3 (.mp3)" or ".WMA (.wma)" cannot be played. In addition, the character codes and number of characters for folder names and file names should be in compliance with the specifications.
	Check if the disc or the file is generated in an irregular format. This may occur depending on the variation or the setting of compressed audio writing applications or other text editing applications.
	Check if the finalization process, such as session close and disc close, is done for the disc.
Poor sound quality	Check if the disc is scratched or dirty.
It takes a relatively long time before the music starts playing.	If there are many folder or file levels on the disc or USB device, some time may be required before the music starts playing.
Music cuts off or skips	The writing software and hardware combination might not match, or the writing speed, writing depth, writing width, etc., might not match the specifications. Try using the slowest writing speed.
Skipping with high bit rate files	Skipping may occur with large quantities of data, such as for high bit rate data.
Move immediately to the next song when playing.	If an unsupported compressed audio file has been given a supported extension like .MP3, or when play is prohibited by copyright protection, the player will skip to the next song.
The songs do not play back in the desired order.	The playback order is the order in which the files were written by the writing software, so the files might not play in the desired order.
	Random/Shuffle may be active on the audio system or on a USB device.

ANTENNA

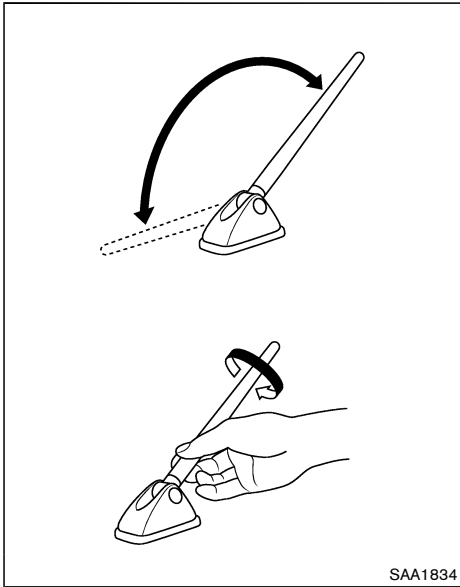

Adjust the antenna angle for the best reception.



CAUTION:

Be sure that antenna is removed before the vehicle enters an automatic car wash.

Removing antenna

You can remove the antenna if necessary.

Hold the bottom of the antenna and remove by turning counterclockwise.

To install the antenna, turn the antenna clockwise and tighten.

FM-AM RADIO WITH COMPACT DISC (CD) PLAYER

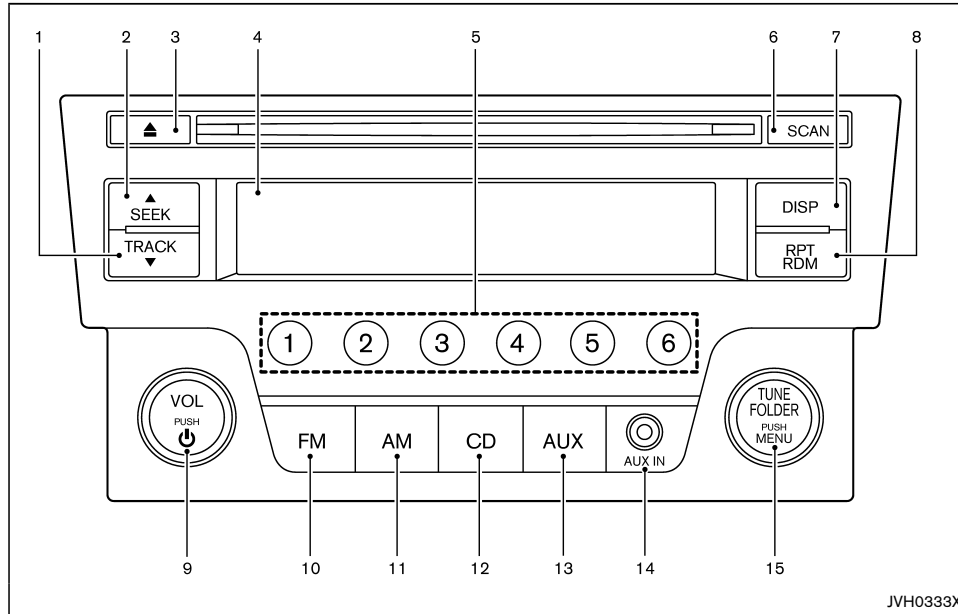

- | | |
|-------------------------------------|------------------------------|
| 1. SEEK/TRACK/Rewind button | 9. VOL (Volume)/Power button |
| 2. SEEK/TRACK/Fast Forward button | 10. FM button |
| 3. CD EJECT button | 11. AM button |
| 4. Display | 12. CD button |
| 5. Radio memory buttons | 13. AUX (Auxiliary) button |
| 6. SCAN button | 14. AUX (Auxiliary) IN jack |
| 7. DISP (Display) button | 15. TUNE-FOLDER/MENU button |
| 8. RPT (Repeat)-RDM (Random) button | |

Audio main operation

The audio system operates when the ignition switch is in the "ACC" or "ON" position.

POWER ON/OFF:

To turn on the audio system, push the VOL/Power button.

- The system will turn on in the mode (radio or CD) which was used immediately before the system was turned off.
- If no CD is loaded, the radio will be turned on.

To turn on and off the audio system, push the VOL/Power button.

Volume control:

To control the volume, turn the VOL/Power button.

Turn the VOL/Power button clockwise to increase the volume.

Turn the VOL/Power button counterclockwise to decrease the volume.

Adjusting sound preference:

1. To adjust the sound settings, push the TUNE-FOLDER/MENU button until the item (Bass, Treble, Balance, Fade, Spd sen Vol (speed sensitive volume) or AUX IN Volume) to be adjusted is displayed.
2. Turn the TUNE-FOLDER/MENU button to adjust the settings.

When no action is taken for 5 seconds, the display will automatically return to the original mode.

Clock setting:

Turning the clock ON/OFF:

1. Push the TUNE-FOLDER/MENU button until “Clock: ON” or “Clock: OFF” is displayed.
2. Turn the TUNE-FOLDER/MENU button to toggle between “Clock: ON” and “Clock: OFF”.

Adjusting the clock:

1. Turn on the clock.
2. Push the TUNE-FOLDER/MENU button until “Adjust Clock: No” is displayed.
3. Turn the TUNE-FOLDER/MENU button until “Adjust Clock: Yes” is displayed.
4. Adjust the hour digits by turning the TUNE-FOLDER/MENU button while the digits are flashing and “Change Hour” is displayed.
5. Push TUNE-FOLDER/MENU button. Adjust the minutes by turning the TUNE-FOLDER/MENU button while the digits are flashing and “Change Minute” is displayed.

When no action is taken for 5 seconds, the display will automatically return to the original mode.

AUX AUX button:

The AUX IN jack is located on the audio unit. The **AUX** IN audio input jack accepts any standard analog audio input such as from a portable cassette tape player, CD player, digital audio player or laptop computer.

Push the AUX button to play a compatible device when it is plugged into the AUX IN jack.

NISSAN strongly recommends using a stereo mini plug cable when connecting your music device to the audio system. Music may not play properly when a monaural cable is used.

Radio operation

The audio system operates when the ignition switch is in the “ACC” or “ON” position.

FM / **AM** FM/AM buttons:

When the **FM** / **AM** button is pushed while the audio system is off, the audio system will turn on and the radio will turn on.

When the **FM** / **AM** button is pushed while another audio source is playing, the other audio source will turn off and the radio will turn on.

To change the radio bands (FM1, FM2, or AM), push the **FM** / **AM** buttons.

TUNE-FOLDER/MENU button:

When adjusting the broadcasting station frequency manually, turn the TUNE-FOLDER/MENU button until the preferred frequency is achieved.

▼ **▲** SEEK/TRACK buttons:

To adjust the broadcasting station frequency automatically, push and release the **▼** or **▲** button. When the system detects a broadcasting station, it will stop at the station.

Detected stations are skipped while **▲** or **▼** button is pushed and held.

SCAN SCAN button:

When the **SCAN** button is pushed, the system will seek and stop at the detected broadcasting station for 5 seconds, and then it will start to seek for the next broadcasting station.

Push the **SCAN** button in this 5-second period to stop seeking.

① ② ③ ④ ⑤ ⑥ Radio memory buttons:

The audio system can store up to 12 FM station frequencies (for FM1 and FM2) and 6 AM station frequencies.

During radio reception, pushing the radio memory button for less than 1.5 seconds will play the stored radio station.

To store the station frequency manually:

1. Tune to the desired broadcasting station frequency using the **▼** **▲** buttons.
2. Push and hold one of the radio memory buttons **①** - **⑥** until a beep sounds.
3. The frequency of the selected channel will appear on the display when the memory is stored properly.
4. Perform steps 1 - 3 for all other memory buttons.

CD player operation

Loading:

Insert a CD into the slot with the label side facing up. The CD will be guided automatically into the slot and will start playing. After the disc is loaded, track information will appear on the display.



CAUTION:

Do not force the CD into the slot. This could damage the player.

CD CD button:

When the **CD** button is pushed while a CD is loaded, the CD will start playing.

DISP **DISP button:**

When the **DISP** is pushed while a CD with title information is playing, the information text on the display will change as follows:

CD:

Track time → Album Title → Artist Name → Song Title
→ Track time



CD with MP3/WMA:

Track time → Folder Title → Album Title → Artist Name
→ Song Title → Track time



SEEK/TRACK (Rewind/Fast Forward) buttons:

Fast forward/Rewind:

Push and hold the  or  button for more than 1.5 seconds to fast forward or rewind through the track. Release the button to play the CD at normal speed.



Track up/down:

To play the next track, push the Fast Forward button for less than 1.5 seconds while a CD is playing.

To play the previous track, push the Rewind button for less than 1.5 seconds within 2 seconds after the current track started playing. To return to the beginning of the current track, push the Rewind button for less than 1.5 seconds after 2 seconds from when the current track started playing.

TUNE-FOLDER/MENU button (CD with MP3/WMA):

To skip to the next folder, turn the TUNE-FOLDER/MENU button.

To skip to the next or previous track within the folder, push   button.

RPT RDM **RPT-RANDOM button:**

When the **RPT RDM** button is pushed while a CD is playing, the play mode will change as follows:

CD:

DISC REPEAT → TRACK REPEAT → DISC RANDOM → DISC REPEAT

CD with MP3/WMA:

DISC REPEAT → FOLDER REPEAT → TRACK REPEAT → DISC RANDOM → FOLDER RANDOM → DISC REPEAT

DISC REPEAT:

All the tracks on the selected CD will play repeatedly in sequential order.

FOLDER REPEAT (CD with MP3 or WMA only):

All the tracks in the selected folder will play repeatedly in sequential order.

TRACK REPEAT:

The selected track will play repeatedly.

DISC RANDOM:

All the tracks on the selected CD will play in random order.

FOLDER RANDOM (CD with MP3 or WMA only):

All the tracks in the selected folder will play repeatedly in random order.

SCAN **SCAN button:**

When the **SCAN** button is pushed while a CD is being played, the first 10 seconds of all the tracks will be played.

When the **SCAN** button is pushed again, the CD will return to the regular play mode.

 **CD EJECT button:**

The CD in the unit will be ejected when the  button is pushed. If the CD is not removed and left ejected in the unit for 20 seconds, it will be reloaded into the slot for protection.

FM-AM RADIO WITH COMPACT DISC (CD) PLAYER (with color display)

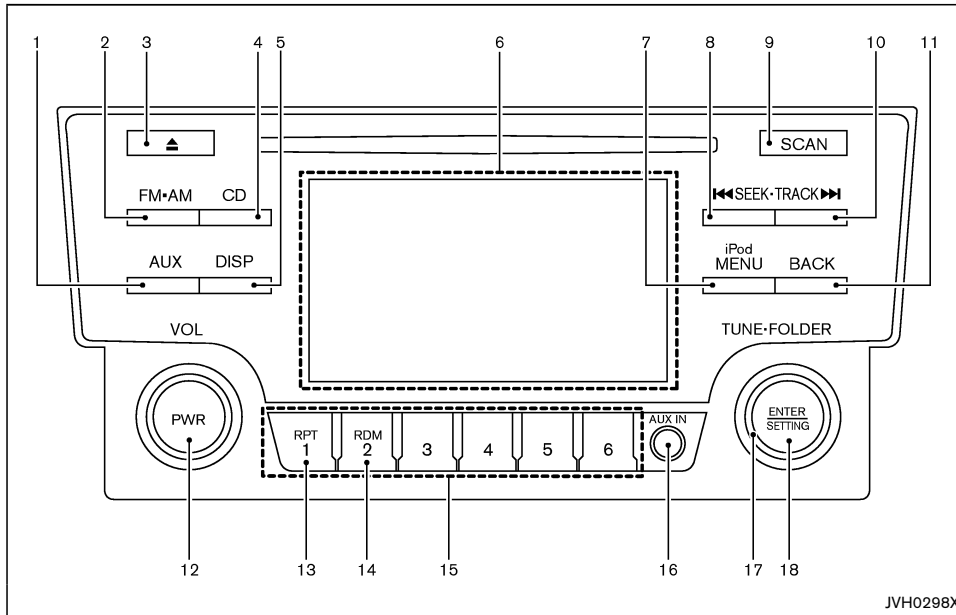

- 17. TUNE-FOLDER control knob
- 18. ENTER/SETTING button

- | | |
|-----------------------------|--|
| 1. AUX (Auxiliary) button | 9. SCAN tuning button |
| 2. FM-AM band select button | 10. SEEK/TRACK/Fast Forward button |
| 3. CD EJECT button | 11. BACK button |
| 4. CD button | 12. PWR (power) button/VOL (volume) control knob |
| 5. DISP (display) button | 13. RPT (repeat) button |
| 6. Color display | 14. RDM (random) button |
| 7. iPod MENU button | 15. Radio station preset select buttons |
| 8. SEEK/TRACK/Rewind button | 16. AUX (Auxiliary) IN jack |

Audio main operation

Head unit:

The auto loudness circuit enhances the low and high frequency ranges automatically in both radio reception and CD playback.

PWR/Volume control:

Place the ignition switch in the ACC or ON position, and then push the PWR button while the system is off to turn on the last audio source, which was playing immediately before the system was turned off. While the system is on, pushing the PWR button turns the system off.

Turn the VOL control knob to adjust the volume.

SETTING SETTING:

The settings screen will appear when pushing the ENTER/SETTING button.

The following items are available in the settings screen.

- Bass, Treble, Balance and Fade

Controls the sound of the audio system. Balance adjusts the sound between the left and right speakers. Fade adjusts the sound between the front and rear speakers.

Select the "Bass", "Treble", "Balance" or "Fade" using the TUNE-FOLDER control knob and then push the ENTER/SETTING button. Turn the TUNE-FOLDER control knob to adjust the Bass, Treble, balance and Fade of the screen to the preferred level.

- Speed Sens Vol.

To change the Speed Sensitive Volume (Speed Sens Vol.) level from off (0) to 5, turn the TUNE-FOLDER control knob.

- AUX Vol.
Controls the volume level of incoming sound when an auxiliary device is connected to the system. Choose a setting between 1 and 3 or choose 0 to disable the feature entirely.
- Brightness and Contrast
Adjust the brightness and contrast of the screen. Select the "brightness" or "contrast" using the TUNE-FOLDER control knob and then push the ENTER/SETTING button. Turn the TUNE-FOLDER control knob to adjust the brightness and contrast of the screen to the preferred level.
- Clock Adjust
Adjust the clock according to the following procedure.

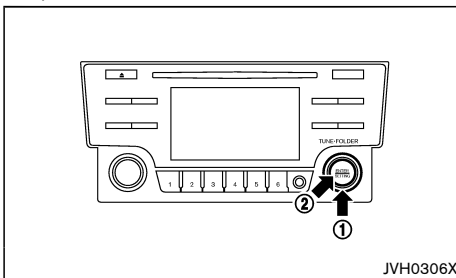

- 1) Select "Clock Adjust" using the TUNE-FOLDER control knob (1) and then push the ENTER/SETTING button (2).
- 2) Adjust the hour with the TUNE-FOLDER control knob (1) and then push the ENTER/SETTING button (2).
- 3) Adjust the minute with the TUNE-FOLDER control knob (1) and then push the ENTER/SETTING button (2).

24 hour clock is not available.

- On-Screen Clock
When this item is turned on, a clock is always displayed in the upper right corner of the screen. Select the "On-Screen Clock" using the TUNE-FOLDER control knob and then push the ENTER/SETTING button. You can toggle between ON and OFF using the TUNE-FOLDER control knob.
- RDS Display (if equipped)
RDS (radio data system) information can be shown on the display. Select "RDS Display" using the TUNE-FOLDER control knob and then push the ENTER/SETTING button. You can toggle between ON and OFF using the TUNE-FOLDER control knob.
- iPod Menu language
The iPod menu language can be changed. Select "iPod menu language" using the TUNE-FOLDER control knob and then push the ENTER/SETTING button. Use the TUNE-FOLDER control knob to select the preferred language.

DISP DISP:

Display of the screen can be canceled by pushing the DISP button. You can then listen to music that is being played back. If you want to display the screen again, either push the DISP button once more or push the FM-AM or AUX button.

AUX IN jack:

The AUX IN jack is located on the audio unit. The AUX IN audio input jack accepts any standard analog audio input such as from a portable cassette tape/CD player, MP3 player or laptop computer.

NISSAN strongly recommends using a stereo mini plug cable when connecting your music device to the

audio system. Music may not play properly when a monaural cable is used.

AUX AUX:

Pushing the AUX button will switch the displays as follows:

iPod/USB → AUX → iPod/USB

When the AUX button is pushed with no device plugged into the jack, the audio system does not change to the AUX mode.

Radio operation

FM • AM radio (FM/AM) band select:

Pushing the radio band select button will change the band as follows:

AM → FM1 → FM2 → AM

TUNE (Tuning):

Turn the radio TUNE-FOLDER control knob for manual tuning.



Radio Data System (RDS) (if equipped):

RDS stands for Radio Data System, and is a data information service transmitted by some radio stations on the FM band (not AM band) encoded within a regular radio broadcast. Currently, most RDS stations are in large cities, but many stations are now considering broadcasting RDS data.

RDS can display:

- Station name, such as “The Groove”.
- Music or programming type such as “Classical”, “Country” or “Rock”.

SEEK tuning:

Push the  or  button to tune from low to high or high to low frequencies and to stop at the next broadcasting station.

SCAN **SCAN tuning:**

Push the SCAN tuning button to tune from low to high frequencies and stop at each broadcasting station for 5 seconds. Pushing the button again during this 5 seconds period will stop SCAN tuning and the radio will remain tuned to that station.

If the SCAN tuning button is not pushed within 5 seconds, SCAN tuning moves to the next station.

1 to **6** **Station memory operations:**

12 stations can be set for the FM band (6 each for FM1 and FM2) and 6 stations can be set for the AM band.

1. Choose the radio band using the radio band select button.
2. Tune to the desired station using the SEEK-TRACK, SCAN button or the radio TUNE-FOLDER control knob.
3. Push and hold the desired station preset button **1** to **6** until the radio mutes.
4. The station indicator will then come on and the sound will resume. Memorizing is now complete.
5. Other buttons can be set in the same manner.

If the battery cable is disconnected, or if the fuse opens, the radio memory will be erased. In that case, reset the desired stations.

CD player operation

Place the ignition switch in the ACC or ON position and insert the Compact Disc (CD) into the slot with the label side facing up. The CD will be guided automatically into the slot and start playing.

After loading the CD, the number of tracks on the CD and the play time will appear on the display.

If the radio is already operating, it will automatically turn off and the CD will play.



If the system has been turned off while the CD was playing, pushing the PWR button will start the CD.



CD **PLAY:**

When the CD button is pushed with the system off and the CD loaded, the system will turn on and the CD will start to play.

When the CD button is pushed with the CD loaded and the radio playing, the radio will automatically be turned off and the CD will start to play.

Next/Previous Track and Fast Forward/Rewind:

When the  or  button is pushed for more than 1.5 seconds while the CD is being played, the CD will play while fast forwarding or rewinding. When the button is released, the CD will return to normal play speed.

When the  or  button is pushed for less than 1.5 seconds while the CD is being played, the next track or the beginning of the current track on the CD will be played.

RPT REPEAT (RPT):

When the RPT button is pushed while the CD is played, the play pattern can be changed as follows:
(CD)

Normal ↔ 1 Track Repeat

(CD with compressed audio files)

Normal → 1 Folder Repeat → 1 Track Repeat → Normal

RDM RANDOM (RDM):

When the RDM button is pushed while a CD is being played, the play pattern can be changed as follows:

(CD)

Normal ↔ 1 Disc Random

(CD with compressed audio files)

Normal → 1 Disc Random → 1 Folder Random → Normal

EJECT CD EJECT:

When the CD EJECT button is pushed with the CD loaded, the CD will be ejected.

When this button is pushed while the CD is being played, the CD will be ejected.

If the CD comes out and is not removed, it will be pulled back into the slot to protect it.

USB memory operation

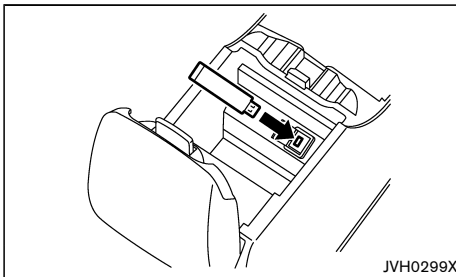

Audio main operation:

The USB outlet connector is located in the center console. Open the lid and connect a USB memory as illustrated.

If the system has been turned off while the USB memory was playing, pushing the PWR button will start the USB memory.



WARNING:

Do not connect, disconnect or operate the USB device while driving. Doing so can be a distraction. If distracted you could lose control of your vehicle and cause an accident or serious injury.



CAUTION:

- **Do not force the USB device into the USB port. Inserting the USB device tilted or upside-down into the port may damage the port. Make sure that the USB device is connected correctly into the USB port.**

- **Do not grab the USB port cover (if equipped) when pulling the USB device out of the port. This could damage the port and the cover.**
- **Do not leave the USB cable in a place where it can be pulled unintentionally. Pulling the cable may damage the port.**

Refer to your device manufacturer's owner information regarding the proper use and care of the device.



AUX PLAY:



When the AUX button is pushed with the system off and the USB memory inserted, the system will turn on.

If another audio source is playing and a USB memory is inserted, push the AUX button repeatedly until the center display changes to the USB memory mode.



Next/Previous File and Fast Forward/Rewind:

When the  or  button is pushed for more than 1.5 seconds while a USB memory is being played, the USB memory will play while forwarding or rewinding. When the button is released, the USB memory will return to normal play speed.

When the  or  button is pushed for less than 1.5 seconds while the USB memory is being played, the next track or the beginning of the current track on the USB memory will be played.

Folder selection:

To change to another folder in the USB memory, turn the TUNE-FOLDER control knob.

RPT REPEAT (RPT):

When the RPT button is pushed while the USB memory is played, the play pattern can be change as follows.

To change the play mode, push the RPT button repeatedly and the mode will change as follows.

Normal → 1 Folder Repeat → 1 Track Repeat → Normal

RDM RANDOM (RDM):

When the RDM button is pushed while a USB memory is being played, the play pattern can be changed as follows.

To change the play mode, push the RDM button repeatedly, and the mode will change as follows.

Normal → All Random → 1 Folder Random → Normal

BACK BACK:

When the BACK button is pushed, it returns to the previous display.

iPod player operation

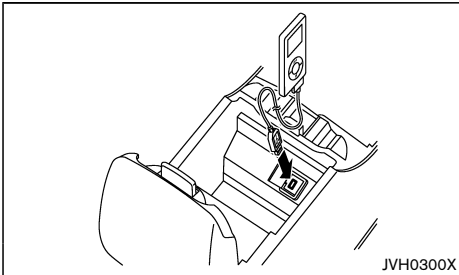

Connecting iPod:

The USB outlet connector is located in the center console. Open the lid and connect the iPod cable to the USB connector. The battery of the iPod is charged while the connection to the vehicle.

Depending on the version of the iPod, the display on the iPod shows a NISSAN or Accessory Attached screen when the connection is completed. When the iPod is connected to the vehicle, the iPod music library can only be operated by the vehicle audio controls.

* iPod and iPhone are a trademark of Apple Inc., registered in the U.S. and other countries.



WARNING:

Do not connect, disconnect or operate the USB device while driving. Doing so can be a distraction. If distracted you could lose control of your vehicle and cause an accident or serious injury.



CAUTION:

- **Do not force the USB device into the USB port. Inserting the USB device tilted or upside-down into the port may damage the port. Make sure that the USB device is connected correctly into the USB port.**
- **Do not grab the USB port cover (if equipped) when pulling the USB device out of the port. This could damage the port and the cover.**
- **Do not leave the USB cable in a place where it can be pulled unintentionally. Pulling the cable may damage the port.**

Refer to your device manufacturer's owner information regarding the proper use and care of the device.

Compatibility:

The following models are compatible:

- Third generation iPhone (Firmware version IOS4/4.0)
- Fourth generation iPhone (Firmware version IOS4/4.0)
- Fifth generation iPod (Firmware version 1.3)
- First generation iPod Classic (Firmware version 1.1.1 or 1.1.2PC)
- Second generation iPod Classic (Firmware version 2.0.1)
- First generation iPod touch (Firmware version 1.1.5 or 2.2.1)
- Second and third generation iPod touch (Firmware version 2.2.1 or IOS4/4.0.0)
- First generation iPod nano (Firmware version 1.3.1)
- Second generation iPod nano (Firmware version 1.1.3)
- Third generation iPod nano (Firmware version 1.1.2PC or 1.1.3PC)
- Fourth generation iPod nano (Firmware version 1.0.2 or 1.0.4)
- Fifth generation iPod nano (Firmware version 1.0.1 or 1.0.2)

The iPod touch may not response quickly with the system in some cases.

Make sure that the iPod firmware is updated.

Audio main operation:

Place the ignition switch to the ACC or ON position. Then, push the AUX button repeatedly to switch to the iPod mode.

If the system has been turned off while the iPod was playing, pushing the PWR button will start the iPod.

iPod MENU iPod MENU:

Place the ignition switch in the ACC or ON position. Then, push the iPod MENU button to switch to the iPod mode.

If another audio source is playing and the iPod is connected, pushing the iPod MENU button changes to the iPod mode.

If the system has been turned off while the iPod was playing, pushing the PWR button will start the iPod.

When the iPod MENU button is pushed while the iPod is connected, the interface for iPod operation is shown on the audio display. The items on the menu list can be scrolled by pushing the **◀** or **▶** while the iPod is operational. To select an item, push ENTER. Items in the iPod menu appear on the display in the following order.

- Now playing
- Playlists
- Artists
- Albums
- songs
- Podcasts
- Genres
- Composers
- Audiobooks
- Shuffle songs
- Play mode

For more information about each item, see the iPod Owner's Manual.

▶▶ **◀◀** Next/Previous Track and Fast Forward/Rewind:

When the **◀◀** or **▶▶** button is pushed for more than 1.5 seconds while the iPod is playing, the iPod will play while fast forwarding or rewinding. When the button is released, the iPod will return to the normal play speed.

When the **◀◀** or **▶▶** button is pushed for less than 1.5 seconds while the iPod is playing, the next track or the beginning of the current track on the iPod will be played.

RPT REPEAT (RPT):

When the RPT button is pushed while a track is being played, the play pattern can be changed as follows:

Repeat Off → 1 Track Repeat → All Repeat → Repeat Off

RDM RANDOM (RDM):

When the RDM button is pushed while a track is being played, the play pattern can be changed as follows:

Shuffle Off → Track Shuffle → Albums Shuffle → Shuffle Off

BACK BACK:

The display will return to the previous screen.

CD/USB MEMORY CARE AND CLEANING CD

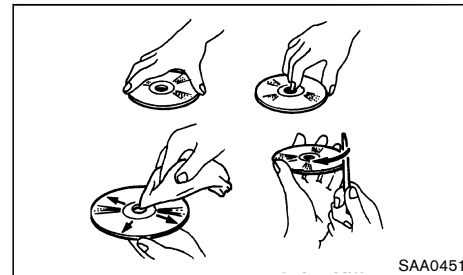

- Handle a disc by its edges. Never touch the surface of the disc. Do not bend the disc.
- Always place the discs in the storage case when they are not being used.
- To clean a disc, wipe the surface from the center to the outer edge using a clean, soft cloth. Do not wipe the disc using a circular motion. Do not use a conventional record cleaner or alcohol intended for industrial use.
- A new disc may be rough on the inner and outer edges. Remove the rough edges by rubbing the inner and outer edges with the side of a pen or pencil as illustrated.

USB memory (if equipped)

- Do not touch the terminal portion of the USB memory.
- Do not place heavy objects on the USB memory.
- Do not store the USB memory in highly humid locations.

- Do not expose the USB memory to direct sunlight.
- Do not spill any liquids on the USB memory.

Refer to the USB memory Owner's Manual for the details.

AUDIO CONTROL STEERING SWITCH (if equipped)

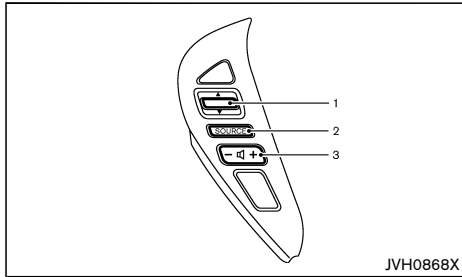

1. Tuning switch
2. Source select switch
3. Volume control switch

The audio system can be operated using the controls on the steering wheel.

Source select switch

Push the source select switch to change the mode to available audio source.

Tuning switch

Memory change (radio):

Push up/down the tuning switch ▲ or ▼ for less than 1.5 seconds to change the radio frequency.

Seek tuning (radio):

Push up/down the tuning switch ▲ or ▼ for more than 1.5 seconds to seek the next or previous radio station.

APS (Automatic Program Search) FF, APS REW (CD):

Push up/down the tuning switch ▲ or ▼ for less than 1.5 seconds to return to the beginning of the present program or skip to the next program. Push several times to skip back or skip through programs.

iPod (if equipped):

- Tilting up/down for less than 1.5 seconds will increase or decrease the track number.

USB (if equipped):

- Tilting up/down for less than 1.5 seconds will increase or decrease the track number.
- Tilting up/down for more than 1.5 seconds will increase/decrease the folder number.

Volume control switch

Push + or - side of the volume control switch to increase or decrease the volume.

USB/AUX CONNECTOR (models with navigation system)

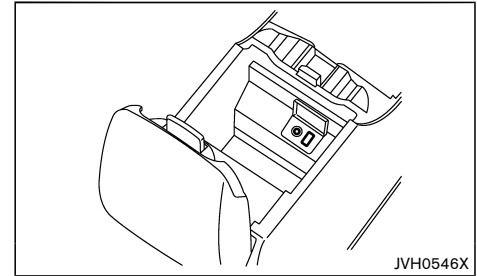

The USB/AUX connector is located in the center console.

For details, see the separately provided NISSAN Connect Owner's Manual.

CAR PHONE OR CB RADIO

When installing a CB, ham radio or a car phone in your vehicle, be sure to observe the following cautions, otherwise the new equipment may adversely affect the Engine Control System and other electronic parts.



CAUTION:

- **Keep the antenna as far away as possible from the Electronic Control Module.**
- **Keep the antenna wire at least 20 cm (8 in) away from the Engine Control harnesses. Do not route the antenna wire next to any harnesses.**
- **Adjust the antenna standing wave ratio as recommended by the manufacturer.**
- **Connect the ground wire from the radio chassis to the body.**
- **For details, consult a NISSAN dealer.**

Bluetooth® HANDS-FREE PHONE SYSTEM (if equipped)

***This system is for models without navigation system.**

For models with navigation system, refer to the NISSAN Connect Owner's Manual.



WARNING:

- **Use a phone after stopping your vehicle in a safe location. If you have to use a phone while driving, exercise extreme caution at all times so full attention may be given to vehicle operation.**
- **If you find yourself unable to devote full attention to vehicle operation while talking on the phone, pull off the road to a safe location and stop your vehicle before doing so.**



CAUTION:

To avoid draining the vehicle battery, use a phone after starting the engine.

NOTE:

Wireless LAN (Wi-Fi) and the Bluetooth® functions share the same frequency band (2.4 GHz). Using the Bluetooth® and the wireless LAN functions at the same time may slow down or disconnect communication and cause undesired noise. It is recommended that you turn off the wireless LAN (Wi-Fi) when using the Bluetooth® functions.

Your vehicle is equipped with Bluetooth® Hands-Free Phone System. If you are an owner of a Bluetooth® enabled cellular phone, you can set up the wireless connection between your cellular phone and the in-vehicle phone module. With Bluetooth® wireless

technology, you can make or receive a telephone call with your cellular phone in your pocket.

Once your cellular phone is paired to the in-vehicle phone module, no phone connecting procedure is required. Your phone is automatically connected with the in-vehicle phone module when the ignition switch is placed in the "ON" position with the registered cellular phone turned on and carried in the vehicle.

You can register up to 5 different Bluetooth® cellular phones in the in-vehicle phone module. However, you can talk on only one cellular phone at a time.

When a call is active, the audio system and microphone (located near the map light) are used for the handsfree communications.

If the audio system is being used at the time, the audio mode will mute and will stay muted until the active call is ended.

Before using the Bluetooth® Hands-Free Phone System, refer to the following notes.

- Set up the wireless connection between a cellular phone and the in-vehicle phone module before using the Bluetooth® Hands-Free Phone System.
- Some Bluetooth® enabled cellular phones may not be recognized by the in-vehicle phone module.
- You will not be able to use a hands-free phone under the following conditions:
 - Your vehicle is outside of the telephone service area.
 - Your vehicle is in an area where it is difficult to receive radio waves; such as in a tunnel, in an underground parking garage, behind a tall building or in a mountainous area.
 - Your cellular phone is locked in order not to be dialed.

- When the radio wave condition is not ideal or ambient sound is too loud, it may be difficult to hear the other person's voice during a call.
- Immediately after the ignition switch is placed in the "ON" position, it may be impossible to receive a call for a short period of time.
- Do not place the cellular phone in an area surrounded by metal or far away from the in-vehicle phone module to prevent tone quality degradation and wireless connection disruption.
- While a cellular phone is connected through the Bluetooth® wireless connection, the battery power of the cellular phone may discharge quicker than usual.
- If the Bluetooth® Hands-Free Phone System seems to be malfunctioning, please contact a NISSAN dealer.
- Some cellular phones or other devices may cause interference or a buzzing noise to come from the audio system speakers. Storing the device in a different location may reduce or eliminate the noise.
- Refer to the cellular phone Owner's Manual regarding the telephone pairing procedure specific to your phone, battery charging, cellular phone antenna, etc.
- The antenna display on the monitor will not coincide with the antenna display of some cellular phones.
- Keep the interior of the vehicle as quiet as possible to hear the caller's voice clearly as well as to minimize its echoes.
- If reception between callers is unclear, adjusting the incoming or outgoing call volume may improve the clarity.

- This wireless hands free car kit is based on Bluetooth® technology,
 - Frequency: 2402 MHz - 2480 MHz
 - Output Power: 4.14 dBm E.I.R.P
 - Modulation: FHSS GFSK 8DPSK, $\pi/4$ DQPSK
 - Number of Channel: 79
 - This wireless equipment can't be used for any services related to safety because there is the possibility of radio interference.

REGULATORY INFORMATION

Bluetooth® trademark



Bluetooth® is a trademark owned by Bluetooth SIG, Inc. and licensed to Visteon Corporation.

CE statement

Hereby "Yangfeng Visteon Automotive Electronics Co., Ltd." declares that this Bluetooth car kit is in compliance with the essential requirements and other relevant provisions of Directive 1999/5/EC.



USING THE SYSTEM

Buttons:

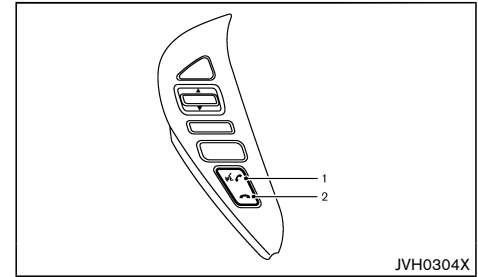

1. PHONE SEND button
2. PHONE END button

Microphone:

Microphone is located near the map light.

The NISSAN Voice Recognition system allows hands-free operation of the Bluetooth® Hands- Free Phone System.



If the vehicle is in motion, some commands may not be available so full attention may be given to vehicle operation.

Setup



Choosing a language:

You can interact with the Bluetooth® Hands- Free Phone System using English, Arabic, Mandarin, Russian or Korean. To change the language, perform the following.

1. Push and hold the PHONE SEND button for more than 5 seconds.
2. The system announces: "Press the PHONE END () button to select a different language."

3. Push the PHONE END  button.
4. The system announces the current language and gives you the option to change the language. Push the SEEK  button to select a different language.

NOTE:

You must push the PHONE SEND  button or the PHONE END  button within 5 seconds to change the language.





5. If you decide not to change the language, do not push either button. After 5 seconds, the VR session will end, and the language will not be changed.

Pairing procedure:

1. Push the PHONE SEND  button. The system asks you to pair a new phone.
2. Initiate pairing from the cellular phone and enter a PIN code for pairing your Bluetooth[®] cellular phone. Operate it to enter the code "1234".
The code is always "1234" regardless of the number of phones paired. The pairing procedure of the cellular phone varies according to each cellular phone manufacturer. See the cellular phone Owner's Manual for details.
3. After the prompt "Please say a name for the phone." by the system, say a name for the phone. If the name is too long, it will not be fully registered.
4. The system will inform you that the cellular phone is successfully registered.

Registering an additional phone:







You can register up to 5 different Bluetooth[®] cellular phones in the in-vehicle phone module. However, you can talk on only one cellular phone at a time.

1. Push the PHONE SEND  button and SEEK  button to select "Connect Phone", and then push the PHONE SEND  button.
2. Push the SEEK  button to select "Add Phone", and then push the PHONE SEND  button.
3. The system asks you to initiate pairing from your Bluetooth[®] cellular phone and enter a PIN code for pairing the phone. Operate it to enter the code "1234".

The pairing procedure of the cellular phone varies according to each cellular phone manufacturer. See the cellular phone Owner's Manual for details.









4. After the prompt "Please say a name for the phone." by the system, say a name for the phone. If the name is too long, it will not be fully registered.
5. The system will inform you that the cellular phone is successfully registered.

Selecting a registered phone:

1. Push the PHONE SEND  button and SEEK  button to select "Connect Phone", and then push the PHONE SEND  button.
2. Push the SEEK  button to select "Select Phone", and then push the PHONE SEND  button.
3. Push the SEEK  button. Each time the button is operated, the system announces the names of the phones. Select the phone you wish to use.

4. Push the PHONE SEND  button to complete the selection.

Deleting a registered phone:

1. Push the PHONE SEND  button and SEEK  button to select "Connect Phone", and then push the PHONE SEND  button.
2. Push the SEEK  button to select "Delete Phone", and then push the PHONE SEND  button.
3. Push the SEEK  button. Each time the button is operated, the system announces the name of the phones. Select the phone you wish to delete.
4. When the system asks if you want to delete, push the PHONE SEND  button. To cancel the deletion, push the PHONE END  button.
5. The system asks you to confirm the deletion. To delete the desired phone, push the PHONE SEND  button again.

NOTE:

When you delete a phone, the associated phonebook for the phone will also be deleted.

Bluetooth[®] on/off:

1. Push the PHONE SEND  button until the system announces "Settings menu".
2. Push the SEEK  button to select Bluetooth[®] on or off.
3. To turn on/off the Bluetooth[®] hands-free phone system, push the PHONE SEND  button.

When Bluetooth[®] is off, you will not be able to make or receive calls by the hands-free mode. Also, you will not have access to the phonebook.

Phonebook







The phonebook stores up to 40 names for each phone paired with the system.

NOTE:

Each phone has its own separate phonebook. You cannot access Phone A's phonebook if you are currently connected with Phone B.











New entry:

This function is not available while driving.

1. Push the PHONE SEND  button and SEEK  button to select "PHONEBOOK", and then push the PHONE SEND  button.
2. Push the SEEK  button to select "Transfer Entry", and then push the PHONE SEND  button.
3. When the system says "Please transfer the phone number from your handset.", operate your cellular phone to send the phonebook to the system.
The memory sending procedure from the Bluetooth® cellular phone varies according to each cellular phone manufacturer. See the cellular phone Owner's Manual for more details.
4. When prompted by the system, say the name that you would like to give for the new entry.
Speak in a natural voice without pausing between words.
5. When the system requires you to repeat the name, say the name again.
6. Push the PHONE SEND  button to continue the entry, or push the PHONE END  button to finish the phone mode.







Delete:

This function is not available while driving.







1. Push the PHONE SEND  button and SEEK  button to select "PHONEBOOK", and then push the PHONE SEND  button.
2. Push the SEEK  button to select "Delete Entry", and then push the PHONE SEND  button.
3. Push the SEEK  button and choose the phonebook entry you wish to delete.
4. When the system asks if you want to delete the contact, push the PHONE SEND  button. To cancel the deletion, push the PHONE END  button.
5. The system asks you to confirm the deletion.
6. To delete the desired contact, push the PHONE SEND  button again.
7. Push the PHONE SEND  button to continue the deletion or push the PHONE END  button to finish the phone mode.

Making a call

Phonebook:

1. Push the PHONE SEND  button and SEEK  button to select "CALL", and then push the PHONE SEND  button.
2. Push the SEEK  button to select "List Name", and then push the PHONE SEND  button.
3. Push the SEEK  button, and choose the phonebook entry you wish to call. The system acknowledges the name and begins the call.

Redial:

1. Push the PHONE SEND  button and SEEK  button to select "CALL", and then push the PHONE SEND  button.
2. Push the SEEK  button to select "Redial", and then push the PHONE SEND  button.
3. Push the PHONE SEND  button, and then the system begins the call.

Bluetooth® cellular phone keypad:

You can also make a call by operating the cellular phone that is registered to the in-vehicle phone module to use the hands-free phone system.

Ending a call:

Push the PHONE END  button on the steering wheel or the off button on the cellular phone.

Receiving or rejecting a call

When you hear the ring tone, push the PHONE SEND  button on the steering wheel.

If you do not wish to answer the call when you hear the ring tone, push the PHONE END  button.

Transferring a call

During a call, push the PHONE SEND  button to switch the call from the Bluetooth® Hands-Free Phone System to the cellular phone when privacy is desired.

Push the PHONE SEND  button again to return to the hands-free mode.

Some Bluetooth® cellular phones may not be able to return to the hands-free mode. Refer to the cellular phone Owner's Manual for information about reconnection.

Once the ignition switch is placed in the "OFF" position and the "ON" position again, the system will

automatically change to the hands-free mode as a default setting.

MEMO

5 Starting and driving

Break-in schedule	5-2	Vehicle Dynamic Control (VDC) system (if equipped)	5-14
Before starting engine	5-2	Vehicle Dynamic Control (VDC) off switch	5-15
Precautions when starting and driving	5-2	Cruise control (if equipped)	5-16
Exhaust gas (carbon monoxide)	5-3	Precautions on cruise control	5-16
Three-way catalyst	5-3	Cruise control operations	5-16
Care when driving	5-4	Parking	5-17
Engine cold start period	5-4	Sonar (parking sensor) system (if equipped)	5-19
Loading luggage	5-4	Trailer towing (except for Australia and New Zealand)	5-20
Driving in wet conditions	5-4	Trailer towing (for Australia and New Zealand)	5-20
Driving in winter conditions	5-4	Operating precautions	5-20
Ignition switch (model without Intelligent Key system)	5-4	Maximum load limits	5-20
Continuously variable transmission (CVT)	5-4	Tire pressure	5-21
Manual transmission (MT)	5-4	Safety chains	5-21
Steering lock	5-5	Trailer brakes	5-21
Key positions	5-5	Trailer detection (if equipped)	5-21
Push-button ignition switch (model with Intelligent Key system)	5-5	Electric power steering system	5-22
Precautions on push-button ignition switch operation	5-5	Brake system	5-22
Intelligent Key system	5-5	Brake precautions	5-22
Steering lock	5-6	Brake assist (if equipped)	5-23
Ignition switch positions	5-6	Anti-lock Braking System (ABS) (if equipped)	5-23
Intelligent Key battery discharge	5-7	Vehicle security	5-24
Starting engine (model without Intelligent Key system)	5-8	Cold weather driving	5-24
Starting engine (model with Intelligent Key system)	5-8	Battery	5-25
Driving vehicle	5-9	Engine coolant	5-25
Driving with Continuously Variable Transmission (CVT)	5-9	Tire equipment	5-25
Driving with manual transmission (MT)	5-13	Special winter equipment	5-25
		Parking brake	5-25
		Corrosion protection	5-25

BREAK-IN SCHEDULE

During the first 1,600 km (1,000 miles), follow these recommendations to obtain maximum engine performance and ensure the future reliability and economy of your new vehicle. Failure to follow these recommendations may result in shortened engine life and reduced engine performance.

- Do not drive at a constant speed, either fast or slow, for long periods of time.
- Do not run the engine over 4,000 rpm.
- Do not accelerate at full throttle in any gear.
- Do not start quickly.
- Do not brake hard as much as possible.
- Do not tow a trailer for at least the first 800 km (500 miles) (for Australia and New Zealand).

BEFORE STARTING ENGINE



WARNING:

The driving characteristics of your vehicle will change remarkably by any additional load and its distribution, as well as by adding optional equipment (roof racks, etc.). Your driving style and speed must be adjusted according to the circumstances. Especially when carrying heavy loads, your speed must be reduced adequately.

- Make sure the area around the vehicle is clear.
- Visually inspect tires for their appearance and condition. Measure and check the tire pressure for proper inflation.
- Check that all windows and lights are clean.
- Adjust the seat and head restraint positions.
- Adjust the inside and outside rear view mirror positions.
- Fasten your seat belt and ask all passengers to do the same.
- Check that all doors are closed.
- Check the operation of the warning lights when the ignition switch is placed in the "ON" position.
- Maintenance items in the "8. Maintenance and do-it-yourself" section should be checked periodically.

PRECAUTIONS WHEN STARTING AND DRIVING



WARNING:

- **Never leave children or adults who would normally require the support of others alone in your vehicle. Pets should not be left alone either. They could unknowingly activate switches or controls and inadvertently become involved in a serious accident and injure themselves. On hot, sunny days, temperatures in a closed vehicle could quickly become high enough to cause severe or possibly fatal illness to people or animals.**
- **Properly secure all luggage to help prevent it from sliding or shifting. Do not place luggage higher than the seatbacks. In a sudden stop or collision, unsecured luggage could cause personal injury.**

NOTE:

During the first few months after purchasing a new vehicle, if you smell strong odors of Volatile Organic Compounds (VOCs) inside the vehicle, ventilate the passenger compartment thoroughly. Open all the windows before entering or while in the vehicle. In addition, when the temperature in the passenger compartment rises, or when the vehicle is parked in direct sunlight for a period of time, turn off the air recirculation mode of the air conditioner and/or open the windows to allow sufficient fresh air into the passenger compartment.

EXHAUST GAS (carbon monoxide)



WARNING:

- Do not breathe exhaust gas; it contains colorless and odorless carbon monoxide. Carbon monoxide is dangerous. It can cause unconsciousness or death.
- If you suspect that exhaust fumes are entering the vehicle, drive with all windows fully open, and have the vehicle inspected immediately.
- Do not run the engine in closed spaces such as a garage.
- Do not park the vehicle with the engine running for an extended period of time.
- Keep the back door closed while driving, otherwise exhaust gas could be drawn into the passenger compartment. If you must drive with the back door open, follow these precautions:
 - Open all the windows.
 - Turn the air recirculation mode off and set the fan speed control to the highest level to circulate the air.
- If a special body or other equipment is added for recreational or other usage, follow the manufacturer's recommendation to prevent carbon monoxide entry into the vehicle. (Some recreational vehicle appliances such as stoves, refrigerators, heaters, etc. may also generate carbon monoxide.)
- The exhaust system and body should be inspected by a qualified mechanic whenever:

- Your vehicle is raised while being serviced.
- You suspect that exhaust fumes are entering into the passenger compartment.
- You notice a change in the sound of the exhaust system.
- You have had an accident involving damage to the exhaust system, underbody, or rear of the vehicle.

THREE-WAY CATALYST



WARNING:

- The exhaust gas and the exhaust system are very hot. Keep people, animals and flammable materials away from the exhaust system components.
- Do not stop or park the vehicle over flammable materials such as dry grass, wastepaper or rags. They may ignite and cause a fire.

The three-way catalyst is an emission control device installed in the exhaust system. Exhaust gas in the three-way catalyst is burned at high temperatures to help reduce pollutants.



CAUTION:

- Do not use leaded gasoline. (See "Recommended fluids/lubricants and capacities" (P.9-2).) Deposits from leaded gasoline seriously reduce the ability of the three-way catalyst to help reduce exhaust pollutants and/or damage the three-way catalyst.

- Keep your engine tuned up. Malfunctions in the ignition, fuel injection, or electrical systems may cause overrich fuel to flow into the three-way catalyst, causing it to overheat. Do not keep driving if the engine misfires, or if noticeable loss of performance or other unusual operating conditions are detected. Have the vehicle inspected promptly by a NISSAN dealer.
- Avoid driving with an extremely low fuel level. Running out of fuel could cause the engine to misfire, damaging the three-way catalyst.
- Do not race the engine while warming it up.
- Do not push or tow your vehicle to start the engine.

CARE WHEN DRIVING

Driving your vehicle to fit the circumstances is essential for your safety and comfort. As a driver, you should be the one who knows best how to drive in the given circumstances.

ENGINE COLD START PERIOD

Due to the higher engine speeds, when the engine is cold, extra caution must be exercised when selecting a gear during the engine warm-up period after starting the engine.

LOADING LUGGAGE

Loads and their distribution and the attachment of equipment (coupling devices, roof luggage carriers, etc.) will considerably change the driving characteristics of the vehicle. Your driving style and speed must be adjusted according to the circumstances.

DRIVING IN WET CONDITIONS

- Avoid accelerating or stopping suddenly.
- Avoid sharp turning or lane changing suddenly.
- Avoid following too close to the vehicle in front.

When water covers the road surface with water puddles, small water streams, etc., reduce speed to prevent hydroplaning which can cause skidding and loss of control. Worn tires will increase this risk.

DRIVING IN WINTER CONDITIONS

- Drive cautiously.
- Avoid accelerating or stopping suddenly.
- Avoid sharp turning or lane changing suddenly.
- Avoid sudden steering.
- Avoid following too close to the vehicle in front.

IGNITION SWITCH (model without Intelligent Key system)



WARNING:

Never remove the key or turn the ignition switch to the "LOCK" position while driving. The steering wheel will lock and could cause the driver to lose control of the vehicle. This could result in serious vehicle damage or personal injury.

CONTINUOUSLY VARIABLE TRANSMISSION (CVT)

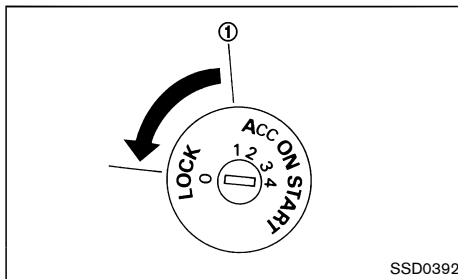

The ignition lock is designed so that the ignition switch cannot be turned to the "LOCK" position until the shift lever is moved to the "P" (Park) position. When moving the ignition switch to the "LOCK" position, to remove the key from the ignition switch, make sure the shift lever is in the "P" (Park) position.

When the ignition switch cannot be turned to the "LOCK" position:

1. Move the shift lever to the "P" (Park) position.
2. Turn the ignition switch slightly in the "ON" direction.
3. Turn the ignition switch to the "LOCK" position.

4. Remove the key.

If the ignition switch is turned to the "LOCK" position, the shift lever cannot be moved from the "P" (Park) position. The shift lever can be moved if the ignition switch is in the "ON" position with the foot brake pedal depressed.

The "OFF" position ① is between the "LOCK" and "ACC" positions, although it is not marked on the ignition switch.

MANUAL TRANSMISSION (MT)

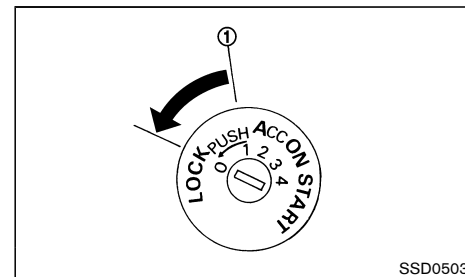

The ignition switch includes a device that helps prevent accidental removal of the key while driving.

The key can only be removed when the ignition switch is in the "LOCK" position.

To turn the ignition switch to the "LOCK" position from the "ACC" or "ON" position, turn the key to the "OFF" position, push the key in, then turn the key to the "LOCK" position.

The "OFF" position ① is between the "LOCK" and "ACC" positions, although it is not labeled on the ignition switch.

STEERING LOCK

To lock steering wheel

1. Turn the ignition switch to the "LOCK" position.
2. Remove the key from the ignition switch.
3. Turn the steering wheel 1/6 of a turn clockwise from the straight up position.

To unlock steering wheel

1. Insert the key into the ignition switch.
2. Gently turn the ignition switch while rotating the steering wheel slightly right and left.

KEY POSITIONS

LOCK (0)

The ignition key can only be removed at this position.

The steering lock can only be locked at this position.

OFF (1)

The engine is turned off with the steering wheel unlocked.

ACC (2)

The electrical accessory power activates without the engine turned on.

ON (3)

The ignition system and the electrical accessory power activate without the engine turned on.

START (4)

The engine starter activates and the engine will start. The ignition switch, when released, will automatically turn to the "ON" position.



CAUTION:

As soon as the engine has started, release the ignition switch immediately.

PUSH-BUTTON IGNITION SWITCH (model with Intelligent Key system)

PRECAUTIONS ON PUSH-BUTTON IGNITION SWITCH OPERATION



WARNING:

Do not operate the push-button ignition switch while driving the vehicle except in an emergency. (The engine will stop when the ignition switch is pushed 3 consecutive times or the ignition switch is pushed and held for more than 2 seconds.) The steering wheel will lock and could cause the driver to lose control of the vehicle. This could result in serious vehicle damage or personal injury.

Before operating the push-button ignition switch, be sure to move the shift lever to the "P" (Park) position (for Continuously Variable Transmission model) or the shift lever to the "N" (Neutral) position (for Manual Transmission model).

INTELLIGENT KEY SYSTEM

The Intelligent Key system can operate the ignition switch without taking the key out from your pocket or bag. The operating environment and/or conditions may affect the Intelligent Key system operation.



CAUTION:

- **Be sure to carry the Intelligent Key with you when operating the vehicle.**
- **Never leave the Intelligent Key inside the vehicle when you leave the vehicle.**
- **If the vehicle battery is discharged, the ignition switch cannot be switched from the "LOCK" position, and if the steering lock is engaged, the steering wheel cannot be moved. Charge the battery as soon as**

possible. (See “Jump starting” (P.6-5).)

Operating range

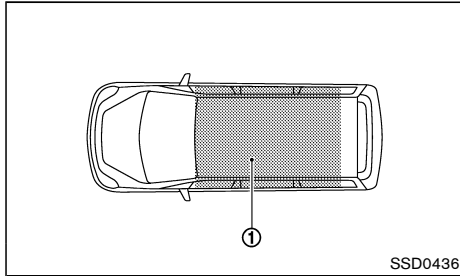

The Intelligent Key can only be used for starting the engine when the Intelligent Key is within the specified operating range ①.

When the Intelligent Key battery is almost discharged or strong radio waves are present near the operating location, the Intelligent Key system's operating range becomes narrower and may not function properly.

If the Intelligent Key is within the operating range, it is possible for anyone, even someone who does not carry the Intelligent Key, to push the ignition switch to start the engine.

- The luggage room area is not included in the operating range, but the Intelligent Key may function.
- If the Intelligent Key is placed on the instrument panel, inside the glove box, door pocket or the corner of the interior compartment, the Intelligent Key may not function.
- If the Intelligent Key is placed near the door or window outside the vehicle, the Intelligent Key may function.

Continuously Variable Transmission (CVT) model

The ignition lock is designed so that the ignition switch cannot be switched to the “LOCK” position until the shift lever is moved to the “P” (Park) position. When pushing the ignition switch to the “OFF” position, make sure the shift lever is in the “P” (Park) position.

When the ignition switch cannot be switched to the “LOCK” position:

1. Move the shift lever to the “P” (Park) position.
2. Push the ignition switch to the “OFF” position.
3. Open the door. The ignition switch will change to the “LOCK” position.

If the ignition switch is switched to the “LOCK” position, the shift lever cannot be moved from the “P” (Park) position. The shift lever can be moved if the ignition switch is in the “ON” position with the foot brake depressed.

STEERING LOCK

The ignition switch is equipped with an anti-theft steering lock device.

To lock steering wheel

1. Push the ignition switch to the “OFF” position where the ignition switch position indicator will not illuminate.
2. Open or close the door. The ignition switch turns to the “LOCK” position.
3. Turn the steering wheel 1/6 of a turn to the right or left from the straight up position.

To unlock steering wheel

Push the ignition switch, and the steering wheel will be automatically unlocked.



CAUTION:

- If the battery of the vehicle is discharged, the push-button ignition switch cannot be switched from the “LOCK” position.
- If the ignition switch position does not change from the “LOCK” position, push the ignition switch again while rotating the steering wheel slightly to the right and left.

IGNITION SWITCH POSITIONS

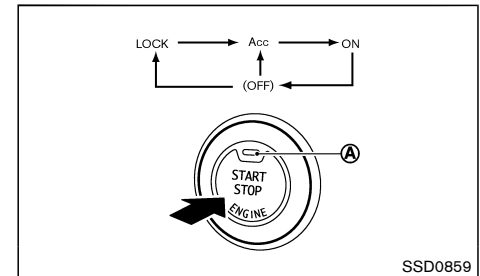

When the ignition switch is pushed without depressing the brake pedal (Continuously Variable Transmission model) or the clutch pedal (Manual Transmission model), the ignition switch position will change as follows:

- Push once to change to “ACC”.
- Push two times to change to “ON”.
- Push three times to change to “OFF”.

- Push four times to return to “ACC”.
- Open or close any door to return to “LOCK” when in the “OFF” position.

The indicator light **A** on the ignition switch illuminates when the ignition switch is in the “ACC” or “ON” position.

LOCK position

The ignition switch and steering lock can only be locked at this position.

The ignition switch will be unlocked when it is pushed to the “ACC” position while carrying the Intelligent Key.

ACC position

The electrical accessory power activates at this position without the engine turned on.

ON position

The ignition system and the electrical accessory power activate at this position without the engine turned on.

OFF position

The engine is turned off with the steering wheel unlocked.



WARNING:

Never push the ignition switch to the “OFF” position while driving. The steering wheel may lock and cause the driver to lose control of the vehicle, resulting in serious vehicle damage or personal injury.



CAUTION:

Do not leave the vehicle for extended periods of time when the ignition switch is in the “ACC” or “ON” position and the engine is not running.

This can discharge the battery.

INTELLIGENT KEY BATTERY DISCHARGE

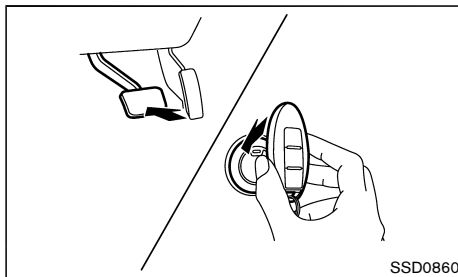

If the battery of the Intelligent Key is discharged, or environmental conditions interfere with the Intelligent Key operation, start the engine according to the following procedure:

1. Continuously Variable Transmission (CVT) model:

Move the shift lever to the “P” (Park) or “N” (Neutral) position.

Manual Transmission (MT) model:

Move the shift lever to the “N” (Neutral) position.

2. Firmly depress the brake pedal.
3. Touch the ignition switch with the Intelligent Key as illustrated. (A chime will sound.)
4. Push the ignition switch while depressing the brake pedal (Continuously Variable Transmission models) or clutch pedal (Manual Transmission models) within 10 seconds after the chime sounds. The engine will start.

After step 3 is performed, when the ignition switch is pushed without depressing the brake pedal (Continuously Variable Transmission models) or clutch

pedal (Manual Transmission models), the ignition switch position will change to “ACC”.

NOTE:

- When the ignition switch is pushed to the “ACC” or “ON” position or the engine is started by the above procedures, the Intelligent Key system warning light may blink in yellow even if the Intelligent Key is inside the vehicle. This is not a malfunction. To stop the warning light from blinking, touch the ignition switch with the Intelligent Key again.
- If the Intelligent Key system warning light in the meter is blinking in green, replace the battery as soon as possible. (See “Battery” (P.8-18).)

STARTING ENGINE (model without Intelligent Key system)

1. Apply the parking brake.
2. Depress the foot brake pedal.
3. **Continuously Variable Transmission (CVT) model:**

Move the shift lever to the “P” (Park) or “N” (Neutral) position.

The starter is designed to operate only when the shift lever is in the proper position.

Manual Transmission (MT) model:

Move the shift lever to the “N” (Neutral) position, and depress the clutch pedal to the floor while starting the engine.

The starter is designed to not operate unless the clutch pedal is depressed.

4. Crank the engine with your foot off the accelerator pedal by turning the ignition switch to the “START” position.
5. Immediately release the ignition switch when the engine starts. If the engine starts, but fails to run, repeat the above procedures.
 - If the engine is very hard to start in extremely cold weather or when restarting, depress the accelerator pedal a little (approximately 1/3 to the floor), hold it and then crank the engine. Release the accelerator pedal when the engine starts.
 - If the engine is very hard to start because it is flooded, depress the accelerator pedal all the way to the floor and hold it. Crank the engine for 5 - 6 seconds. After cranking the engine, release the accelerator pedal. Crank the engine **with your foot off the accelerator pedal** by turning the ignition switch to START. Release the ignition switch when the engine starts. If the engine starts, but fails to run, repeat the above

procedure.



CAUTION:

- **Do not operate the starter for more than 15 seconds at a time. If the engine does not start, turn the ignition switch off and wait 10 seconds before cranking the engine again. Otherwise, the starter could be damaged.**
 - **If it becomes necessary to start the engine with a booster battery and jumper cables, the instructions and cautions contained in the “6. In case of emergency” section should be carefully followed.**
6. Allow the engine to idle for at least 30 seconds after starting the engine to warm-up. Drive at moderate speeds for a short distance first, especially in cold weather.



CAUTION:

Do not leave the vehicle unattended while the engine is warming up.

STARTING ENGINE (model with Intelligent Key system)

1. Apply the parking brake.
2. **Continuously Variable Transmission (CVT) model:**

Move the shift lever to the “P” (Park) or the “N” (Neutral) position.

The starter is designed to operate only when the shift lever is in the proper position.

Manual Transmission (MT) model:

Move the shift lever to the “N” (Neutral) position.

The starter is designed to not operate unless the clutch pedal is fully depressed.

The Intelligent Key must be carried when operating the ignition switch.

3. Push the ignition switch to the “ON” position. Depress the brake pedal (CVT model) or the clutch pedal (MT model) and push the ignition switch to start the engine.

To start the engine immediately, push and release the ignition switch while depressing the brake pedal or clutch pedal with the ignition switch in any position.

4. If the engine starts, but fails to run, repeat the above procedures.
 - If the engine is very hard to start in extremely cold weather or when restarting, depress the accelerator pedal a little (approximately 1/3 to the floor), hold it and then crank the engine. Release the accelerator pedal when the engine starts.
 - If the engine is very hard to start because it is flooded, depress the accelerator pedal all the way to the floor and hold it. Crank the engine for 5 - 6 seconds. After cranking the engine, release the accelerator pedal. Crank the engine **with your foot off the accelerator pedal** by

turning the ignition switch to START. Release the ignition switch when the engine starts. If the engine starts, but fails to run, repeat the above procedure.

 **CAUTION:**

- **As soon as the engine has started, release the ignition switch immediately.**
 - **Do not operate the starter for more than 15 seconds at a time. If the engine does not start, push the ignition switch to the “OFF” position and wait 10 seconds before cranking the engine again. Otherwise, the starter could be damaged.**
 - **If it becomes necessary to start the engine with a booster battery and jumper cables, the instructions and cautions contained in the “6. In case of emergency” section should be carefully followed.**
5. Allow the engine to idle for at least 30 seconds after starting the engine to warm-up. Drive at moderate speeds for a short distance first, especially in cold weather.

 **CAUTION:**

Do not leave the vehicle unattended while the engine is warming up.

6. To stop the engine, move the shift lever to the “P” (Park) position (CVT model) or move the shift lever to the “N” (Neutral) position (MT model), apply the parking brake and push the ignition switch to the “OFF” position.

DRIVING VEHICLE

DRIVING WITH CONTINUOUSLY VARIABLE TRANSMISSION (CVT)

The Continuously Variable Transmission (CVT) in your vehicle is electronically controlled to produce maximum power and smooth operation.

The recommended operating procedures for this transmission are shown on the following pages. Follow these procedures for maximum vehicle performance and driving enjoyment.

 **WARNING:**

Do not downshift abruptly on slippery roads. This may cause a loss of control.

 **CAUTION:**

- **The cold engine idle speed is high, so use caution when shifting the transmission into a forward or reverse position before the engine has warmed up.**
- **Avoid revving up the engine while the vehicle is stopped. This could cause unexpected vehicle movement.**
- **Never shift to either the “P” (Park) or “R” (Reverse) position while the vehicle is moving. This could cause serious damage to the transmission.**
- **Except in an emergency, do not shift to the “N” (Neutral) position while driving. Coasting with the transmission in the “N” (Neutral) position may cause serious damage to the transmission.**
- **Start the engine in either the “P” (Park) or “N” (Neutral) position. The engine will not start in any other position. If it does, have**

your vehicle checked by a NISSAN dealer.

- **Shift into the “P” (Park) position and apply the parking brake when at a standstill for longer than a short waiting period.**
- **Keep the engine at idling speed while shifting from the “N” (Neutral) position to any driving position.**
- **When stopping the vehicle on an uphill grade, do not hold the vehicle by depressing the accelerator pedal. The foot brake pedal should be depressed in this situation.**

Starting vehicle

1. After starting the engine, fully depress the foot brake pedal before moving the shift lever out of the “P” (Park) position.
2. Keep the foot brake pedal depressed and move the shift lever to a driving position.
3. Release the parking brake, the foot brake pedal, and then gradually start the vehicle in motion.

The CVT is designed so the foot brake pedal MUST be depressed before shifting from the “P” (Park) position to any driving position while the ignition switch is in the “ON” position.

The shift lever cannot be moved out of the “P” (Park) position and into any of the other positions if the ignition switch is placed in the “LOCK”, “OFF” or “ACC” position or if the key is removed.

 **CAUTION:**

- **DEPRESS THE FOOT BRAKE PEDAL - Shifting the shift lever to “D”, “R”, “L” or the manual shift mode without depressing the foot brake pedal causes the vehicle to move**

slowly when the engine is running. Make sure the foot brake pedal is depressed fully and the vehicle is stopped before shifting the shift lever.

- **MAKE SURE OF THE SHIFT LEVER POSITION** - Make sure the shift lever is in the desired position. "D" and "L" or manual shift mode are used to move forward and "R" to back up.
- **WARM UP THE ENGINE** - Due to the higher idle speeds when the engine is cold, extra caution must be exercised when shifting the shift lever into the driving position immediately after starting the engine.

Shifting

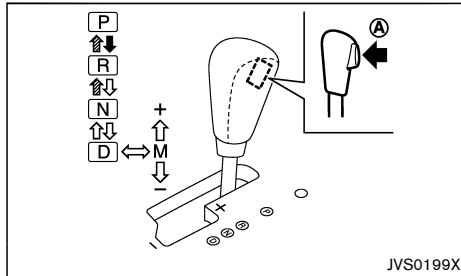

With manual shift mode (RHD model)

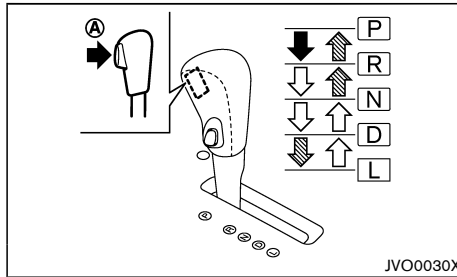

Without manual shift mode (LHD model)

- ➔: Push the button (A) while depressing the foot brake pedal.
- ↕: Push the button (A).
- ➡: Just move the shift lever.



WARNING:

- **Apply the parking brake if the shift lever is in any position while the engine is not running. Failure to do so could cause the vehicle to move unexpectedly or roll away and result in serious personal injury or property damage.**
- **If the shift lever cannot be moved from the "P" (Park) position while the engine is running and the foot brake pedal is depressed, the stop lights may not work. Malfunctioning stop lights could cause an accident injuring yourself and others.**

After starting the engine, fully depress the foot brake pedal, push the shift lever button and move the shift lever out of the "P" (Park) position.

If the ignition switch is placed in the "OFF" or "ACC" position for any reason while the shift lever is in any

positions other than the "P" (Park) position, the ignition switch cannot be placed in the "LOCK" position.

If the ignition switch cannot be placed in the "LOCK" position, perform the following steps:

1. Apply the parking brake.
2. Place the ignition switch in the "ON" position while depressing the foot brake pedal.
3. Move the shift lever to the "P" (Park) position.
4. **Models with Intelligent Key system:**

Place the ignition switch in the "OFF" position.

Models without Intelligent Key system:

Place the ignition switch in the "LOCK" position.

P (Park):

Use this position when the vehicle is parked or when starting the engine. **Make sure that the vehicle is completely stopped and move the shift lever into the "P" (Park) position.** Apply the parking brake. When parking on a hill, first depress the foot brake pedal, apply the parking brake, and then move the shift lever into the "P" (Park) position.

R (Reverse):

Use this position to back up. Make sure that the vehicle is completely stopped before selecting the "R" (Reverse) position.

N (Neutral):

Neither the forward nor reverse gear is engaged. The engine can be started in this position. You may shift to the "N" (Neutral) position and restart a stalled engine while the vehicle is moving.

D (Drive):

Use this position for all normal forward driving.

L (Low) (if equipped):

Use this position when climbing steep hills slowly or driving slowly through deep snow, sand or mud, or for maximum engine braking on steep downhill grades.

Manual shift mode (if equipped)

When the shift lever is shifted from the “D” position to the manual shift gate with the vehicle stopped or while driving, the transmission enters the manual shift mode. Shift ranges can be selected manually.

In the manual shift mode, the shift range is displayed on the position indicator in the meter.

Shift ranges up or down one by one as follows:

M1 → M2 → M3 → M4 → M5 → M6
← ← ← ← ← ← ← ← ← ← ← ← ← ← ← ←

- When shifting up, move the shift lever to the + (up) side. (Shifts to higher range.)
- When shifting down, move the shift lever to the – (down) side. (Shifts to lower range.)
- Moving the shift lever to the same side twice will shift the ranges in succession. However, if this motion is rapidly done, the second shifting may not be completed properly.

M6 (Sixth):

Use this position for all normal forward driving at highway speeds.

However, you need to shift down the gears manually when accelerating or passing another vehicle.

M5 (Fifth):

Use this position when driving up long slopes, or for engine braking when driving down long slopes.

M4 (Fourth), M3 (Third) and M2 (Second):

Use for hill climbing or engine braking on downhill grades.

M1 (First):

Use this position when climbing steep hills slowly or driving slowly through deep snow, sand or mud or for maximum engine braking on steep downhill grades.

- Remember not to drive at high speeds for extended periods of time in lower than M6 range. This reduces fuel economy.
- **In the manual shift mode, the transmission automatically shifts down to M1 (First) before the vehicle comes to a stop. When accelerating again, it is necessary to shift up to the desired range.**
- **In the manual shift mode, the transmission may not shift to the selected gear. This helps maintain driving performance and reduces the chance of vehicle damage or loss of control. When this situation occurs, the Continuously Variable Transmission (CVT) position indicator (on the Vehicle information display) will blink and the buzzer will sound.**
- When canceling the manual shift mode, return the shift lever to the “D” position. The transmission returns to the normal driving mode.
- When the CVT fluid temperature is extremely low, the manual shift mode may not work and automatically shift as a drive mode. This is not a malfunction. In this case, return the shift lever to the “D” position and drive for a while and then shift

to the manual shift mode.

- When the CVT fluid temperature is high, the shift range may upshift in lower rpm than usual. This is not a malfunction.

SPORT mode switch (if equipped)

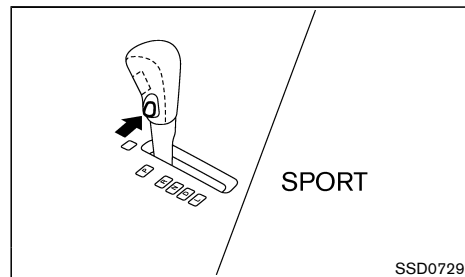

LHD model

To select the SPORT mode, push the SPORT mode switch with the shift lever in the “D” (Drive) position. The SPORT mode indicator light **SPORT** in the meter panel illuminates. To turn off the SPORT mode, push the SPORT mode switch again. The SPORT mode indicator light will turn off. When the shift lever is shifted to any position other than “D”, the SPORT mode will be automatically turned off.

“OFF” position:

For normal driving and fuel economy, use the “OFF” position.

“ON” position:

For driving up or down long slopes where engine braking is necessary, or for powerful acceleration, use the “ON” position. The transmission will automatically select a different gear ratio, allowing the engine to turn the SPORT mode off.

When driving conditions change, push the switch to

turn the SPORT mode off.

Remember not to drive at high speeds for extended periods of time with the SPORT mode in the "ON" position. This reduces fuel economy.

Accelerator downshift - in the "D" position -

For passing or climbing hills, depress the accelerator pedal to the floor. This shifts the transmission down into a lower gear, depending on the vehicle speed.

Shift lock release

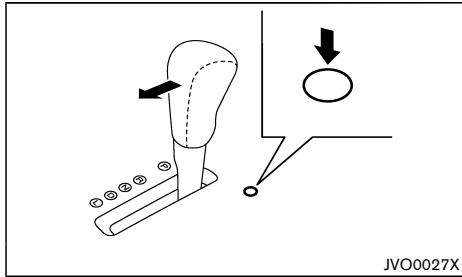

Without manual shift mode (LHD model)

If the battery charge is low or discharged, the shift lever may not be moved from the "P" (Park) position even with the brake pedal depressed and the shift lever button pushed.

To move the shift lever, perform the following procedure:

1. Models with Intelligent Key system:

Place the ignition switch in the "OFF" or "LOCK" position.

Models without Intelligent Key system:

Place the ignition switch in the "LOCK" position, and remove the key if it is inserted.

2. Apply the parking brake.
3. Push the shift lever button and move the shift lever to the "N" (Neutral) position while holding down the shift lock release.

Place the ignition switch in the "ON" position to unlock the steering wheel. The vehicle may be moved to the desired location.

For model with Intelligent Key system: If the battery is discharged completely, the steering wheel cannot be unlocked. Do not move the vehicle with the steering wheel locked.

If the shift lever cannot be moved out of the "P" (Park) position, have a NISSAN dealer check the CVT system as soon as possible.



WARNING:

If the shift lever cannot be moved from the "P" (Park) position while the engine is running and the brake pedal is depressed, the stop lights may not work. Malfunctioning stop lights could cause an accident injuring yourself and others.

High fluid temperature protection mode

This transmission has a high fluid temperature protection mode. If the fluid temperature becomes too high (for example, when climbing steep grades in high temperature with heavy loads, such as when towing a trailer), engine power and, under some conditions, vehicle speed will be decreased automatically to reduce the chance of transmission damage. Vehicle speed can be controlled with the accelerator pedal, but engine and vehicle speed may be limited.

Fail-safe

When the fail-safe operation occurs, the CVT will not be shifted to the selected driving position.

If the vehicle is driven under extreme conditions, such as excessive wheel spinning and subsequent hard braking, the fail-safe system may be activated. This will occur even if all electrical circuits are functioning properly. In this case, place the ignition switch in the "OFF" position and wait for 10 seconds. Then turn the ignition switch back to the "ON" position. The vehicle should return to its normal operating condition. If it does not return to its normal operating condition, have a NISSAN dealer check the transmission and repair it if necessary.



WARNING:

When the fail-safe operation occurs, vehicle speed may be gradually reduced. The reduced speed may be lower than other traffic, which could increase the chance of a collision. Be especially careful when driving. If necessary, pull to the side of the road at a safe place and allow the transmission to return to normal operation, or have it repaired if necessary.

DRIVING WITH MANUAL TRANSMISSION (MT)



WARNING:

- Do not downshift abruptly on slippery roads. This may cause a loss of vehicle control.
- Do not over-rev the engine when shifting to a lower gear. This may cause a loss of vehicle control or engine damage.



CAUTION:

- Do not rest your foot on the clutch pedal while driving. This may damage the clutch system.
- Fully depress the clutch pedal before shifting to help prevent transmission damage.
- Stop the vehicle completely before shifting into the “R” (Reverse) position.
- When the vehicle is stopped for a period of time, for example waiting at stoplights, shift to the “N” (Neutral) position and release the clutch pedal with the foot brake pedal depressed.
- Do not shift to the “N” (Neutral) position while driving. Doing so may result in an accident due to loss of engine braking.

Starting vehicle

1. After starting the engine, depress the clutch pedal to the floor and move the shift lever to the “1” (1st) or “R” (Reverse) position.
2. Slowly depress the accelerator pedal, releasing the clutch pedal and parking brake at the same time.

Shifting gear

To change gears, or when upshifting or downshifting, fully depress the clutch pedal, shift into the appropriate gear, then slowly and smoothly release the clutch pedal.

To ensure smooth gear changes, fully depress the clutch pedal before operating the shift lever. If the clutch pedal is not fully depressed before the transmission is shifted, a gear noise may be heard. Transmission damage could occur.

Start the vehicle in the “1” (1st) position and shift to the “2” (2nd), “3” (3rd), “4” (4th), “5” (5th) and “6” (6th) (if equipped) gear in sequence according to the vehicle speed.

If it is difficult to move the shift lever into the “R” (Reverse) or “1” (1st) position, shift to the “N” (Neutral) position, and then release the clutch pedal once. Fully depress the clutch pedal again and shift into “R” or “1”.

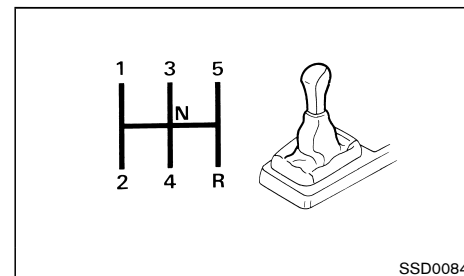

SSD0084

5-speed Manual Transmission (MT) model:

You cannot shift directly from the “5” (5th) position into the R (Reverse) position. First shift into the N (Neutral) position, then shift into the R (Reverse) position.

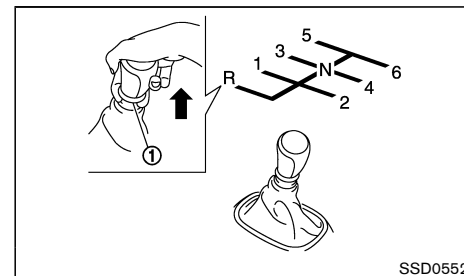

SSD0552

6-speed Manual Transmission (MT) model:

- To reverse, stop the vehicle and move the shift lever into the N (Neutral) position, and then pull the ring ① upward to shift into the R (Reverse) position.
- The ring returns to its original position when the shift lever is moved to the N (Neutral) position.

VEHICLE DYNAMIC CONTROL (VDC) SYSTEM (if equipped)

Suggested maximum speed in each gear

Downshift to a lower gear if the engine is not running smoothly, or if you need to accelerate.

Do not exceed the maximum suggested speed (shown below) in any gear. For level road driving, use the highest gear suggested for that speed. Always observe posted speed limits, and drive according to the road conditions which will ensure safe operation. Do not over-rev the engine when shifting to a lower gear as it may cause engine damage or loss of vehicle control.

5-speed Manual Transmission (MT) model:

HR16DE engine model:

	km/h (MPH)
1st	45 (28)
2nd	83 (51)
3rd	121 (75)
4th	164 (102)
5th	— (—)

6-speed Manual Transmission (MT) model:

MRA8DE engine model:





	km/h (MPH)
1st	47(29)
2nd	84(52)
3rd	117(72)
4th	152(94)
5th	— (—)
6th	— (—)

MR16DDT engine model:

	km/h (MPH)
1st	49(30)
2nd	85(53)
3rd	119(74)
4th	149(92)
5th	182(113)
6th	— (—)



WARNING:

- The Vehicle Dynamic Control (VDC) system is designed to help the driver maintain stability but does not prevent accidents due to abrupt steering operation at high speeds or by careless or dangerous driving techniques. Reduce vehicle speed and be especially careful when driving and cornering on slippery surfaces and always drive carefully.
- Do not modify the vehicle's suspension. If suspension parts such as shock absorbers, struts, springs, stabilizer bars, bushings and wheels are not NISSAN recommended for your vehicle or are extremely deteriorated, the VDC system may not operate properly. This could adversely affect vehicle handling performance, and the VDC warning light  may illuminate.
- If brake related parts such as brake pads, rotors and calipers are not NISSAN recommended or are extremely deteriorated, the VDC system may not operate properly and the VDC warning light  may illuminate.
- If engine control related parts are not NISSAN recommended or are extremely deteriorated, the VDC warning light  may illuminate.
- When driving on extremely inclined surfaces such as higher banked corners, the VDC system may not operate properly and the VDC warning light  may illuminate. Do not drive on these types of roads.
- When driving on an unstable surface such as a turntable, ferry, elevator or ramp, the VDC

warning light  may illuminate. This is not a malfunction. Restart the engine after driving onto a stable surface.

- **If wheels or tires other than the NISSAN recommended ones are used, the VDC system may not operate properly and the VDC warning light  may illuminate.**
- **The VDC system is not a substitute for winter tires or tire chains on a snow covered road.**

The Vehicle Dynamic Control (VDC) system uses various sensors to monitor driver inputs and vehicle motion. Under certain driving conditions, the VDC system helps to perform the following functions.

- Controls brake pressure to reduce wheel slip on one slipping drive wheel so power is transferred to a non slipping drive wheel on the same axle.
- Controls brake pressure and engine output to reduce drive wheel slip based on vehicle speed (traction control function).
- Controls brake pressure at individual wheels and engine output to help the driver maintain control of the vehicle in the following conditions:
 - understeer (vehicle tends to not follow the steered path despite increased steering input)
 - oversteer (vehicle tends to spin due to certain road or driving conditions).



The VDC system can help the driver to maintain control of the vehicle, but it cannot prevent loss of vehicle control in all driving situations.

When the VDC system operates, the VDC warning light  in the instrument panel flashes so note the following:

- The road may be slippery or the system may determine some action is required to help the vehicle on the steered path.

- You may feel a pulsation in the brake pedal and hear a noise or vibration from under the hood. This is normal and indicates that the VDC system is working properly.
- Adjust your speed and driving to the road conditions.

If a malfunction occurs in the system, the VDC warning light  illuminates in the instrument panel. The VDC system automatically turns off.

The VDC OFF switch is used to turn off the VDC system. The VDC off indicator light  illuminates to indicate the VDC system is off. When the VDC OFF switch is used to turn off the system, the VDC system still operates to prevent one drive wheel from slipping by transferring power to a non slipping drive wheel. The VDC warning light  flashes if this occurs. All other VDC functions are off and the VDC warning light  will not flash. The VDC system is automatically reset to on when the ignition switch is placed in the “OFF” position then back to the “ON” position.

See “Vehicle Dynamic Control (VDC) warning light” (P.2-14) and “Vehicle Dynamic Control (VDC) off indicator light” (P.2-16).

The computer has a built-in diagnostic feature that tests the system each time you start the engine and move the vehicle forward or in reverse at a slow speed. When the self-test occurs, you may hear a “clunk” noise and/or feel a pulsation in the brake pedal. This is normal and is not an indication of a malfunction.

VEHICLE DYNAMIC CONTROL (VDC) OFF SWITCH

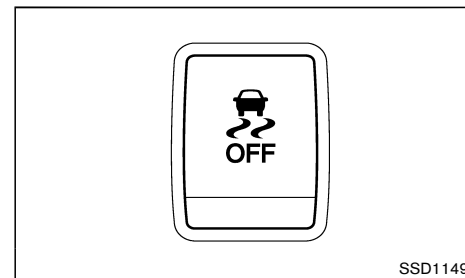

The vehicle should be driven with the Vehicle Dynamic Control (VDC) system ON for most driving conditions.

When the vehicle is stuck in mud or snow, the VDC system reduces the engine output to reduce wheel spin. The engine speed will be reduced even if the accelerator is depressed to the floor. If maximum engine power is needed to free a stuck vehicle, turn the VDC system off.

To turn off the VDC system, push the VDC OFF switch. The  indicator light will illuminate.

Push the VDC OFF switch again or restart the engine to turn ON the system.

CRUISE CONTROL (if equipped)

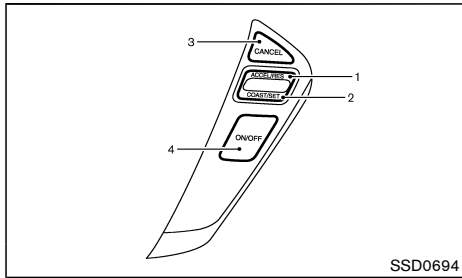

1. RESUME/ACCELERATE switch
2. SET/COAST switch
3. CANCEL switch
4. Cruise control MAIN switch

WARNING:

- **Always observe the posted speed limits and do not set the speed over them.**
- **Do not use the cruise control when driving under the following conditions. Doing so could cause a loss of vehicle control and result in an accident.**
 - When it is not possible to keep the vehicle at a constant speed
 - When driving in heavy traffic
 - When driving in traffic that varies speed
 - When driving in windy areas
 - When driving on winding or hilly roads
 - When driving on slippery (rain, snow, ice, etc.) roads

CAUTION:

On manual Transmission (MT) model, do not shift to the “N” (Neutral) position without depressing the clutch pedal when the cruise control is operated. Should this occur, depress the clutch pedal and turn the cruise control MAIN switch off immediately. Failure to do so may cause engine damage.

PRECAUTIONS ON CRUISE CONTROL

- If the cruise control system malfunctions, it will cancel automatically. The CRUISE indicator light on the meter panel will then blink to warn the driver.
- If the engine coolant temperature becomes excessively high, the cruise control system will cancel automatically.
- If the CRUISE indicator light blinks, turn the cruise control MAIN switch off and have the system checked by a NISSAN dealer.
- The CRUISE indicator light may blink when the cruise control MAIN switch is turned ON while pushing the RESUME/ACCELERATE, SET/COAST or CANCEL switch. To properly set the cruise control system, perform the following procedures.

CRUISE CONTROL OPERATIONS

The cruise control allows driving at speeds above 40 km/h (25 MPH) without keeping your foot on the accelerator pedal.

The cruise control will automatically be canceled if the vehicle slows down more than approximately 13 km/h (8 MPH) below the set speed.

Moving the shift lever to the “N” (Neutral) position (Continuously Variable Transmission model) or depressing the clutch pedal (Manual Transmission model) will cancel the cruise control and the CRUISE indicator light will turn off.

Turning on cruise control

Push the cruise control MAIN switch. The CRUISE indicator light illuminates.

Setting cruising speed

1. Accelerate to the desired speed.
2. Push the SET/COAST switch and release it.
3. Take your foot off the accelerator pedal.

The vehicle will maintain the set speed.

Passing another vehicle:

Depress the accelerator pedal to accelerate. After releasing the accelerator pedal, the vehicle will return to the previously set speed.

The vehicle may not maintain the set speed when going up or down steep hills. In such cases, drive without the cruise control.

Resetting to slower speed:

Use any one of the following methods to reset to a slower speed.

- Lightly tap the foot brake pedal. When the vehicle reaches the desired speed, push and release the SET/COAST switch.
- Push and hold the SET/COAST switch. When the vehicle reaches the desired speed, release the SET/COAST switch.
- Quickly push and release the SET/COAST switch. This will reduce the vehicle speed by about 1 km/h (0.6 MPH).

Resetting to faster speed:

Use any one of the following methods to reset to a faster speed.

- Depress the accelerator pedal. When the vehicle reaches the desired speed, push and release the SET/COAST switch.
- Push and hold the RESUME/ACCELERATE switch. When the vehicle reaches the desired speed, release the RESUME/ACCELERATE switch.
- Quickly push and release the RESUME/ACCELERATE switch. This will increase the vehicle speed by about 1 km/h (0.6 MPH).

Resuming at preset speed:

Push and release the RESUME/ACCELERATE switch.

The vehicle will resume the last set cruising speed when the vehicle speed is over 40 km/h (25 MPH).

Canceling cruising speed

Use any one of the following methods to cancel the set speed.

- Push the CANCEL switch.
- Tap the foot brake pedal.
- Push the cruise control MAIN switch. The CRUISE indicator light turns off.

PARKING



WARNING:

- **Do not stop or park the vehicle over flammable materials such as dry grass, waste paper or rags. They may ignite and cause a fire.**
- **Safe parking procedures require that both the parking brake be applied and the shift lever placed in the “P” (Park) position (Continuously Variable Transmission model) or the shift lever placed in an appropriate gear (Manual Transmission model). Failure to do so could cause the vehicle to move unexpectedly or roll away and result in an accident.**
- **When parking the vehicle, make sure the shift lever is moved to the “P” (Park) position. The shift lever cannot be moved out of the “P” (Park) position without depressing the foot brake pedal (CVT model).**
- **Never leave the engine running while the vehicle is unattended.**
- **Never leave children or adults who would normally require the support of others alone in the vehicle. Pets should not be left alone either. They could unknowingly activate switches or controls and inadvertently become involved in a serious accident and injure themselves. On hot, sunny days, temperatures in a closed vehicle could quickly become high enough to cause severe or possibly fatal illness to people and animals.**

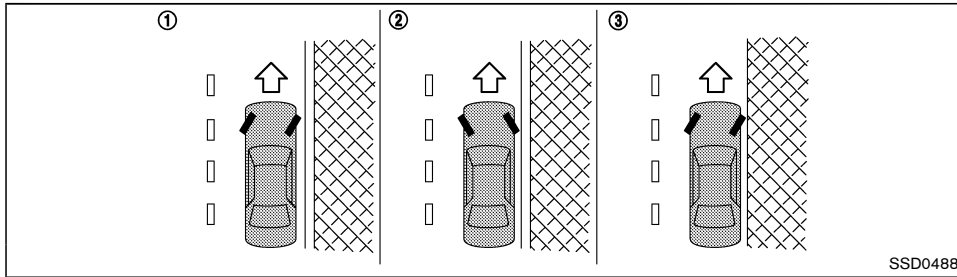

Left-Hand Drive (LHD) models

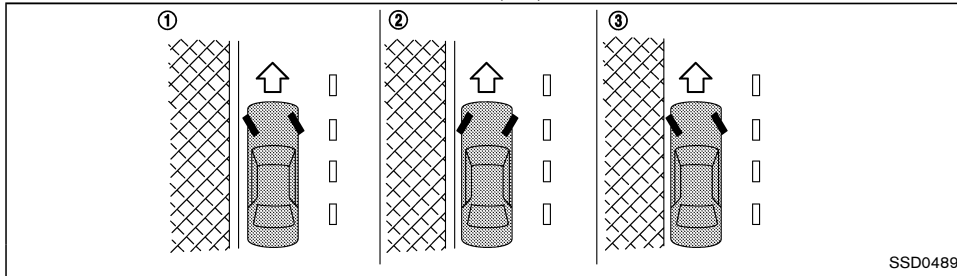

Right-Hand Drive (RHD) models

1. Firmly apply the parking brake.
2. Continuously Variable Transmission (CVT) model:
Move the shift lever to the "P" (Park) position.
Manual Transmission (MT) model: Move the shift lever to the "R" (Reverse) position. When parking on an uphill grade, move the shift lever to the "1" (1st) position.
3. To help prevent the vehicle from moving into traffic when parked on an incline, it is a good practice to turn the wheels as illustrated.
HEADED DOWNHILL WITH CURB ①
Turn the wheels towards the curb and move the

vehicle forward until the curb side wheel gently touches the curb. Then apply the parking brake.

HEADED UPHILL WITH CURB ②

Turn the wheels away from the curb and allow the vehicle to move back until the curb side wheel gently touches the curb. Then apply the parking brake.

HEADED UPHILL OR DOWNHILL, WITHOUT CURB ③

Turn the wheels toward the side of the road so the vehicle will move away from the center of the road if the vehicle moves. Then apply the parking brake.

4. Model with Intelligent Key system:

Place the ignition switch in the "OFF" position.

Model without Intelligent Key system:

Place the ignition switch in the "LOCK" position and remove the key.

SONAR (parking sensor) SYSTEM (if equipped)

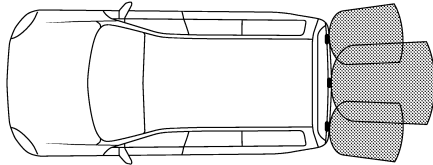

JVS0086X



WARNING:

- The sonar (parking sensor) system is a convenience but it is not a substitute for proper parking. Always look around and check that it is safe to do so before parking. Always move slowly.
- Read and understand the limitations of the sonar (parking sensor) system as contained in this section. Inclement weather may affect the function of the sonar (parking sensor) system; this may include reduced performance or a false activation.
- This system is not designed to prevent contact with small or moving objects.
- The system is designed as an aid to the driver in detecting large stationary objects to help avoid damaging the vehicle. The system will not detect small objects below the bumper, and may not detect objects close to the bumper or on the ground.
- If your vehicle sustains damage to the bumper fascia, leaving it misaligned or bent, the sensing zone may be altered causing

inaccurate measurement of obstacles or false alarms.



CAUTION:

Keep the interior of the vehicle as quiet as possible to hear the tone clearly.

When the ignition switch is in the "ON" position, the sonar (parking sensor) system is operational.

The sonar (parking sensor) system sounds a tone to warn the driver of obstacles near the bumper. The system detects rear obstacles when the shift lever is in the "R" (Reverse) position. The system may not detect objects at speeds above 10 km/h (6 MPH) and may not detect certain angular or moving objects.

The sonar (parking sensor) system detects obstacles up to 1 m (3.3 ft) from the bumper with a decreased coverage area at the outer corners of the bumper, (refer to the illustration for approximate zone coverage areas). As you move closer to the obstacle, the rate of the tone increases. When the obstacle is less than 30 cm (11.8 in) away, the tone will sound continuously.

Keep the sonar sensors (located on the bumper fascia) free from snow, ice and large accumulations of dirt (do

not clean the sensors with sharp objects). If the sensors are covered, it will affect the accuracy of the sonar (parking sensor) system.

If the sonar (parking sensor) system malfunctions, the beep sounds for 3 seconds when the shift lever is moved to the "R" (Reverse) position. Have the system checked by a NISSAN dealer.

TRAILER TOWING (except for Australia and New Zealand)

Your vehicle was designed to be used to carry passengers and luggage. NISSAN does not recommend trailer towing, because it places additional loads on your vehicle's engine, drivetrain, steering, braking and other systems.



CAUTION:

Vehicle damage resulting from towing a trailer is not covered by the warranty.

TRAILER TOWING (for Australia and New Zealand)

Your new vehicle was designed to be used primarily to carry passengers and luggage.

Towing a trailer will place additional loads on your vehicle's engine, drive train, steering, braking and other systems. The towing of a trailer will exaggerate other conditions such as sway caused by crosswinds, rough road surfaces or passing trucks.

Your driving style and speed must be adjusted according to the circumstances. Before towing a trailer, see a NISSAN dealer for an explanation about the proper use of towing equipment.

OPERATING PRECAUTIONS

- Avoid towing a trailer during the break-in period.
- Before driving, make sure that the lighting system of the trailer works properly.
- Observe the legal maximum speeds for trailer operation.
- Avoid abrupt starts, accelerations and stops.
- Avoid sharp turns and lane changes.
- Always drive your vehicle at a moderate speed.
- Follow the trailer manufacturer's instructions.
- Choose proper coupling devices (trailer hitch, safety chain, roof carrier, etc.) for your vehicle and trailer. These devices are available from a NISSAN dealer where you can also obtain more detailed information about trailer towing.
- Never allow the total trailer load (trailer weight plus its cargo weight) to exceed the maximum set for the vehicle and the coupling device. See a NISSAN dealer for more information.
- The trailer must be loaded so that heavy goods are placed over the axle. The maximum allowable vertical load on the trailer hitch must not be exceeded.

- Have your vehicle serviced more often than at the intervals specified in a separate maintenance booklet.
- Trailer towing requires more fuel than under normal circumstances because of a considerable increase in traction power and resistance.

While towing a trailer, check the engine coolant temperature indicator to prevent the vehicle from overheating.

MAXIMUM LOAD LIMITS

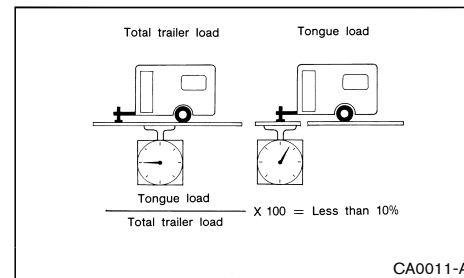

Maximum trailer loads (including tires and other loaded equipment):

1. Never allow the total trailer load to exceed:
 - The maximum 750 kg (1,654 lb) for a trailer without brakes.
 - For MRA8DE engine model, the maximum 1,200 kg (2,646 lb) for a trailer with brakes.
 - For MR16DDT engine model, the maximum 1,100 kg (2,426 lb) for a trailer with brakes.
2. The total trailer load must be lower than the following three values even if it does not exceed the maximum permissible trailer loads.

- Towing capacity displayed on a tow-bar.
- Trailer's gross vehicle mass marked on a coupling body.
- Gross vehicle mass marked on a trailer data plate.

The maximum trailer load which can be towed by your vehicle depends on the towing equipment fitted to the vehicle. Therefore, it is important to not only have the correct equipment fitted but also to use it correctly. Towing loads greater than the value specified for your vehicle or using towing equipment which is not provided by NISSAN could seriously affect the handling and/or performance of your vehicle.

Vehicle damage resulting from improper towing procedures is not covered by NISSAN warranties. Information on trailer towing and the required equipment should be obtained from a NISSAN dealer.

Maximum tongue load

Never allow the tongue load to exceed 10% of the total trailer load. If the tongue load exceeds 10%, rearrange the cargo in the trailer.

Maximum rear gross axle weight

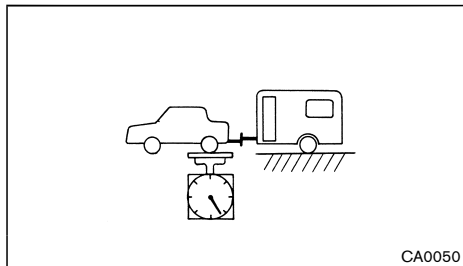

The rear gross axle weight must not exceed the Gross Axle Weight Rating (GAWR).

GAWR

	MRA8DE engine model		MR16DDT engine model	
	CVT model	MT model	CVT model	MT model
Front	905 kg (1,996 lb)	895 kg (1,973 lb)	980 kg (2,161 lb)	945 kg (2,084 lb)
Rear	845 kg (1,863 lb)	845 kg (1,863 lb)	850 kg (1,874 lb)	855 kg (1,885 lb)

The trailer must be loaded so that heavy goods are placed over the axle.

TIRE PRESSURE

When towing a trailer, inflate the vehicle tires to the maximum recommended COLD tire pressure (for full loading) indicated on the tire placard.

Do not tow a trailer when the vehicle is installed with a temporary spare tire or a compact spare tire.

SAFETY CHAINS

Always use a suitable chain between the vehicle and trailer. The chain should be crossed and should be attached to the hitch, not to the vehicle bumper or axle. Be sure to leave enough slack in the chain to permit turning corners.

TRAILER BRAKES

Ensure that trailer brakes are installed as required by local regulations. Also check that all other trailer equipment conforms to local regulations.

Always block the wheels on both the vehicle and trailer when parking. Apply the hand brake on the trailer if equipped. Parking on a steep slope is not recommended.

If parking on a steep slope is unavoidable, place the shift lever in the "P" (Park) position (Continuously Variable Transmission model) or the shift lever in an appropriate gear (Manual Transmission model), and turn the front wheels towards the curb.

TRAILER DETECTION (if equipped)

When towing a trailer with a genuine NISSAN tow bar electrical kit and the turn signal switch is used, the electrical system of the vehicle will detect the additional electrical load of the trailer lighting. As a result, the direction indicator tone will be different.

ELECTRIC POWER STEERING SYSTEM



WARNING:

- **If the engine is not running or is turned off while driving, the power assist for the steering will not work. The steering will be much harder to operate.**
- **When the electric power steering warning light illuminates with the engine running, the power assist for the steering will cease operation. You will still have control of the vehicle but the steering will be harder to operate.**

The electric power steering system is designed to provide power assist while driving to operate the steering wheel with light force.

When the steering wheel is operated repeatedly or continuously while parking or driving at a very low speed, the power assist for the steering wheel will be reduced. This is to prevent overheating of the electric power steering system and protect it from getting damaged. While the power assist is reduced, steering wheel operation will become heavy. When the temperature of the electric power steering system goes down, the power assist level will return to normal. Avoid repeating such steering wheel operations that could cause the electric power steering system to overheat.

You may hear a fricative sound when the steering wheel is operated quickly. However, this is not a malfunction.

If the electric power steering warning light **PS** illuminates while the engine is running, it may indicate the electric power steering system is not functioning properly and may need servicing. Have the electric power steering system checked by a NISSAN dealer. (See "Electric power steering warning light" (P.2-13).)

5-22 Starting and driving

When the electric power steering warning light illuminates with the engine running, the power assist for the steering will cease operation. You will still have control of the vehicle. However, greater steering effort is needed, especially in sharp turns and at low speeds.

BRAKE SYSTEM

The brake system has two separate hydraulic circuits. If one circuit malfunctions, you will still have braking ability at two wheels.

BRAKE PRECAUTIONS

Vacuum assisted brakes

The brake booster aids braking by using engine vacuum. If the engine stops, you can stop the vehicle by depressing the foot brake pedal. However, greater foot pressure on the foot brake pedal will be required to stop the vehicle. The stopping distance will be longer.

If the engine is not running or is turned off while driving, the power assisted brakes will not function. Braking will be harder.



WARNING:

Do not coast with the engine stopped.

For model with Brake Assist: When the brake pedal is depressed slowly and firmly, you may hear a clicking noise and feel a slight pulsation. This is normal and indicates that the Brake Assist System is operating.

Using brakes

Avoid resting your foot on the foot brake pedal while driving. This will overheat the brakes, wear out the brake linings/pads faster, and increase fuel consumption.

To help reduce brake wear and to prevent the brakes from overheating, reduce speed and downshift to a lower gear before going down a slope or long grade. Overheated brakes may reduce braking performance and could result in loss of vehicle control.

While driving on a slippery surface, be careful when braking, accelerating or downshifting. Abrupt braking

or acceleration could cause the wheels to skid and result in an accident.

Wet brakes

When the vehicle is washed or driven through water, the brakes may get wet. As a result, your braking distance will be longer and the vehicle may pull to one side during braking.

To dry the brakes, drive the vehicle at a safe speed while lightly depressing the foot brake pedal to heat up the brakes. Do this until the brakes return to normal. Avoid driving the vehicle at high speeds until the brakes function correctly.

Parking brake break-in

Break in the parking brake shoes whenever the stopping effect of the parking brake is weakened or whenever the parking brake shoes and/or drums/rotors are replaced, in order to assure the best braking performance.

This procedure is described in the vehicle service manual and can be performed by a NISSAN dealer.

Driving uphill

When starting on a steep grade, it is sometimes difficult to operate both the brake and clutch (for Manual Transmission model). Apply the parking brake to hold the vehicle. Do not slip the clutch. When ready to start, slowly release the parking brake while depressing the accelerator pedal and releasing the clutch pedal.

Driving downhill

The engine braking action is effective for controlling the vehicle while descending hills. For Manual Transmission (MT) model, the shift lever should be placed in the lower speed position prior to descending. For Continuously Variable Transmission (CVT) model, the manual shift mode or the "L" position should be selected.

BRAKE ASSIST (if equipped)

When the force applied to the brake pedal exceeds a certain level, the Brake Assist is activated generating greater braking force than a conventional brake booster even with light pedal force.



WARNING:

The Brake Assist is only an aid to assist braking operation and is not a collision warning or avoidance device. It is the driver's responsibility to stay alert, drive safely and be in control of the vehicle at all times.

ANTI-LOCK BRAKING SYSTEM (ABS) (if equipped)



WARNING:

- **The Anti-lock Braking System (ABS) is a sophisticated device, but it cannot prevent accidents resulting from careless or dangerous driving techniques. It can help maintain vehicle control during braking on slippery surfaces. Remember that stopping distances on slippery surfaces will be longer than on normal surfaces even with ABS. Stopping distances may also be longer on rough, gravel or snow covered roads, or if you are**

using tire chains. Always maintain a safe distance from the vehicle in front of you. Ultimately, the driver is responsible for safety.

- **Tire type and condition may also affect braking effectiveness.**
 - **When replacing tires, install the specified size of tires on all four wheels.**
 - **When installing a spare tire, make sure that it is the proper size and type as specified on the tire placard. (See "Tire placard" (P.9-9).)**
 - **For detailed information, see "Tires and wheels" (P.8-31).**

The Anti-lock Braking System (ABS) controls the brakes so the wheels do not lock during hard braking or when braking on slippery surfaces. The system detects the rotation speed at each wheel and varies the brake fluid pressure to prevent each wheel from locking and sliding. By preventing each wheel from locking, the system helps the driver maintain steering control and helps to minimize swerving and spinning on slippery surfaces.

Using system

Depress the brake pedal and hold it down. Depress the brake pedal with firm steady pressure, but do not pump the brakes. The ABS will operate to prevent the wheels from locking up. Steer the vehicle to avoid obstacles.



WARNING:

Do not pump the brake pedal. Doing so may result in increased stopping distances.

VEHICLE SECURITY

Self-test feature

The ABS includes electronic sensors, electric pumps, hydraulic solenoids and a computer. The computer has a built-in diagnostic feature that tests the system each time you start the engine and move the vehicle at a low speed in forward or reverse. When the self-test occurs, you may hear a “clunk” noise and/or feel a pulsation in the brake pedal. This is normal and does not indicate a malfunction. If the computer senses a malfunction, it switches the ABS off and illuminates the ABS warning light on the instrument panel. The brake system then operates normally, but without anti-lock assistance.

If the ABS warning light illuminates during the self-test or while driving, have the vehicle checked by a NISSAN dealer.

Normal operation

The ABS operates at speeds above 5 to 10 km/h (3 to 6 MPH). The speed varies according to road conditions.

When the ABS senses that one or more wheels are close to locking up, the actuator rapidly applies and releases hydraulic pressure. This action is similar to pumping the brakes very quickly. You may feel a pulsation in the brake pedal and hear a noise from under the hood or feel a vibration from the actuator when it is operating. This is normal and indicates that the ABS is operating properly. However, the pulsation may indicate that road conditions are hazardous and extra care is required while driving.

When leaving your vehicle unoccupied:

- Always take the key with you - even when leaving the vehicle in your own garage.
- Close all windows completely and lock all doors.
- Always park your vehicle where it can be seen. Park in a well lit area during the night.
- If the security system is equipped, use it - even for a short period.
- Never leave children or pets in the vehicle unattended.
- Never leave valuables inside the vehicle. Always take valuables with you.
- Never leave the vehicle documents in the vehicle.
- Never leave articles on a roof rack. Remove them from the rack and keep and lock them inside the vehicle.
- Never leave the spare key in the vehicle.

COLD WEATHER DRIVING



WARNING:

- **Whatever the condition, drive with caution. Accelerate and decelerate with great care. If accelerating or decelerating too fast, the drive wheels will lose even more traction.**
- **Allow more stopping distance in cold weather driving. Braking should be started sooner than on dry pavement.**
- **Keep at a greater distance from the vehicle in front of you on slippery roads.**
- **Wet ice (0°C, 32°F and freezing rain), very cold snow and ice can be slick and very difficult to drive on. The vehicle will have a lot less traction or grip under these conditions. Try to avoid driving on wet ice until the road is salted or sanded.**
- **Watch for slippery spots (glaring ice). These may appear on an otherwise clear road in shaded areas. If a patch of ice is seen ahead, brake before reaching it. Try not to brake while actually on the ice, and avoid any sudden steering maneuvers.**
- **Do not use cruise control on slippery roads.**
- **Snow can trap dangerous exhaust gas under your vehicle. Keep snow clear of the exhaust pipe and from around your vehicle.**

BATTERY

If the battery is not fully charged during extremely cold weather conditions, the battery fluid may freeze and damage the battery. To maintain maximum efficiency, the battery should be checked regularly. For details, see "Battery" (P.8-18).

ENGINE COOLANT

If the vehicle is to be left outside without anti-freeze, drain the cooling system, including the engine block. Refill before operating the vehicle. For details, see "Changing engine coolant" (P.8-8).

TIRE EQUIPMENT

1. If you have snow tires installed on the front/rear wheels of your vehicle, they should be of the same size, loading range, construction and type (bias, bias-belted or radial) as the rear/front tires.
2. If the vehicle is to be operated in severe winter conditions, snow tires should be installed on all four wheels.
3. For additional traction on icy roads, studded tires may be used. However, some countries, provinces and states prohibit their use. Check local, state and provincial laws before installing studded tires.

Skid and traction capabilities of studded snow tires, on wet or dry surfaces, may be poorer than that of non-studded snow tires.

4. Snow chains may be used if desired. Make sure they are the proper size for the tires on your vehicle and are installed according to the chain manufacturer's instructions. Use chain tensioners when recommended by the tire chain manufacturer to ensure a tight fit. Loose end links of the tire chains must be secured or removed to prevent the possibility of whipping action damage to the

fenders or underbody. In addition, drive at a reduced speed, otherwise, your vehicle may be damaged and/or vehicle handling and performance may be adversely affected.

SPECIAL WINTER EQUIPMENT

It is recommended that the following items be carried in the vehicle during the winter:

- A scraper and stiff-bristled brush to remove ice and snow from the windows.
- A sturdy, flat board to be placed under the jack to give it firm support.
- A shovel to dig the vehicle out of snowdrifts.

PARKING BRAKE

When parking in the area where the outside temperature is below 0°C (32°F), do not apply the parking brake to prevent it from freezing. For safe parking:

- Place the shift lever in the "P" (Park) position (Continuously Variable Transmission (CVT) model).
- Place the shift lever in the "1" (1st) or "R" (Reverse) position (Manual Transmission (MT) model).
- Securely block the wheels.

CORROSION PROTECTION

Chemicals used for road surface deicing are extremely corrosive and will accelerate corrosion and the deterioration of underbody components such as the exhaust system, fuel and brake lines, brake cables, floor pan and fenders.

In the winter, the underbody must be cleaned periodically. For additional information, see "Corrosion protection" (P.7-5).

For additional protection against rust and corrosion,

which may be required in some areas, consult a NISSAN dealer.

MEMO

6 In case of emergency

Hazard indicator flasher switch	6-2	Jump starting	6-5
Flat tire	6-2	Push starting	6-7
Stopping vehicle	6-2	If your vehicle overheats	6-7
Preparing tools and spare tire	6-2	Towing your vehicle	6-8
Blocking wheels	6-3	Towing precautions	6-8
Removing wheel cover (if equipped)	6-3	Towing recommended by NISSAN	6-8
Removing tire	6-3		
Installing spare tire	6-4		
Stowing damaged tire and tools	6-5		



HAZARD INDICATOR FLASHER SWITCH

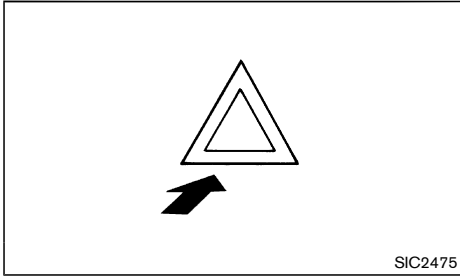

The hazard indicator flasher switch operates regardless of the ignition switch position except when the battery is discharged.

The hazard indicator flasher is used to warn other drivers when you have to stop or park under emergency conditions.

When the hazard indicator flasher switch is pushed, all turn signal lights will flash. To turn off the hazard indicator flasher, push the hazard indicator flasher switch again.

FLAT TIRE

If you have a flat tire, follow the instructions as follows.

STOPPING VEHICLE



WARNING:

- Be sure to apply the parking brake firmly.
- Be sure to move the shift lever to the "R" (Reverse) position (Manual Transmission (MT) model).
- Be sure to move the shift lever to the "P" (Park) position (Continuously Variable Transmission (CVT) model).
- **Never change tires when the vehicle is on a slope, ice or slippery area. This is hazardous.**
- **Never change tires when the oncoming traffic is close to your vehicle. Call for professional road assistance.**

1. Safely move the vehicle off the road away from traffic.
2. Turn on the hazard indicator flasher lights.
3. Park on a level surface.
4. Apply the parking brake.
5. Continuously Variable Transmission (CVT) model: Move the shift lever to the "P" (Park) position.
Manual Transmission (MT) model: Move the shift lever to the "R" (Reverse) position.
6. Turn off the engine.
7. Open the hood:
 - To warn other traffic.
 - To signal professional road assistance personnel that you need assistance.
8. Have all passengers get out from the vehicle and stand in a safe place, away from other traffic and

clear of the vehicle.

PREPARING TOOLS AND SPARE TIRE

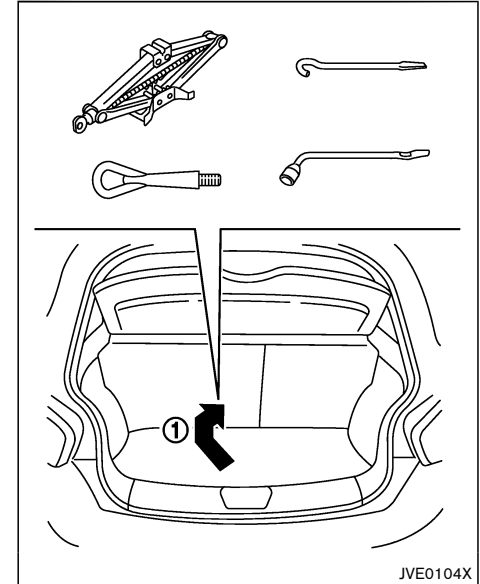

Open the back door. Raise the cargo floor board ①. Remove jacking tools.

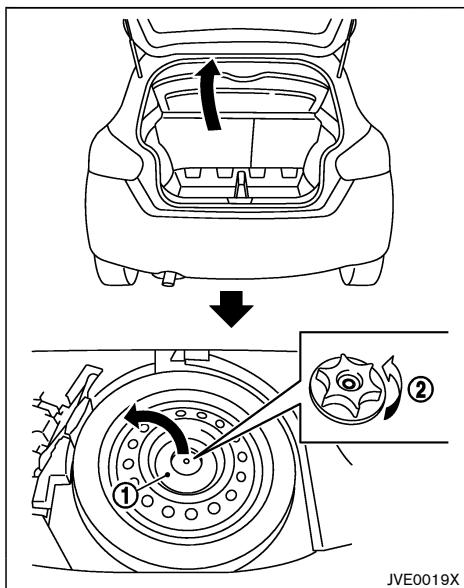

JVE0019X

The spare tire is located under the cargo floor board. Loosen the clamp (2) and remove the spacer (1) and take out the spare tire.

BLOCKING WHEELS

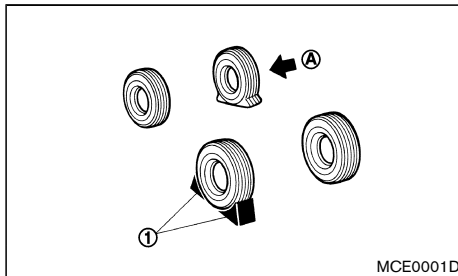

MCE0001D

WARNING:

Be sure to block the appropriate wheel to prevent the vehicle from moving, which may cause personal injury.

Place suitable blocks (1) at both the front and back of the wheel diagonally opposite the flat tire (A) to prevent the vehicle from moving when it is jacked up.

REMOVING WHEEL COVER (if equipped)

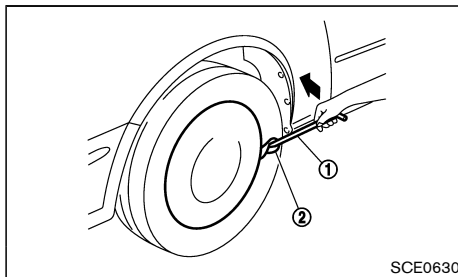

SCE0630

WARNING:

Never use your hands to remove the wheel cover. This may cause personal injury.

To remove the wheel cover, use the jack rod (1) as illustrated.

Apply cloth (2) between the wheel and jack rod to prevent damaging the wheel and wheel cover.

REMOVING TIRE

Jacking up vehicle

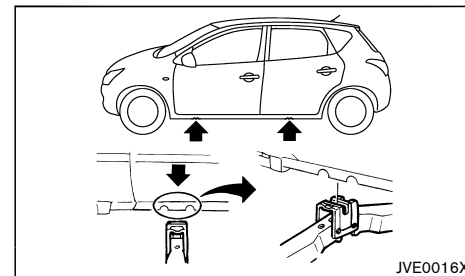

JVE0016X

Jack-up points

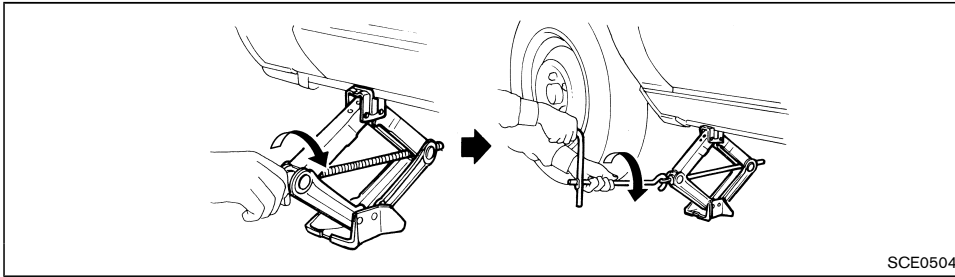

SCE0504

WARNING:

- Be sure to read and follow the instructions in this section.
- **DO NOT GET UNDER A VEHICLE THAT IS SUPPORTED BY A JACK.**
- Never use a jack which is not provided with your vehicle.
- The jack, which is provided with your vehicle, is designed only to lift your vehicle during a tire change. Do not use the jack provided with your vehicle on other vehicles.
- Never jack up the vehicle at a location other than the jack-up point that is specified.
- Never lift the vehicle more than necessary.
- Never use blocks on or under the jack.
- Never start or run the engine while the vehicle is on the jack. The vehicle may move suddenly, and this may cause an accident.
- Never allow passengers to remain in the vehicle while the tire is off the ground.

- Be sure to read the caution label attached to the jack body before using.

1. Place the jack directly under the jack-up point as illustrated so that the top of the jack contacts the vehicle at the jack-up point.

The jack should be placed on firm level ground.

2. Align the jack head between the two notches located at the jack-up point of either the front or the rear section.
3. Fit the groove of the jack head between the notches as shown.

Do not remove the wheel nuts until the tire is off the ground.

4. Loosen each wheel nut, counterclockwise, one or two turns with the wheel nut wrench.
5. Carefully raise the vehicle until the clearance between the tire and ground is achieved.
6. To lift the vehicle, securely hold the jack lever and rod with both hands and turn the jack lever.

Removing tire

1. Remove the wheel nuts.
2. Remove the damaged tire.



CAUTION:

The tire is heavy. Be sure that your feet are clear from the tire and use gloves as necessary to avoid injury.

INSTALLING SPARE TIRE

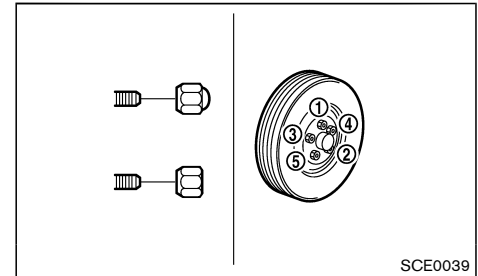

SCE0039



WARNING:

- **Never use wheel nuts which are not provided with your vehicle. Incorrect wheel nuts or improperly tightened wheel nuts may cause the wheel to become loose or come off. This could cause an accident.**

- **Never use oil or grease on the wheel studs or nuts. This may cause the wheel nuts to become loose.**

1. Clean any mud or dirt from the surface between the wheel and hub.

2. Carefully put the spare tire on and tighten the wheel nuts with your fingers. Check that all the wheel nuts contact the wheel surface horizontally.
3. Tighten the wheel nuts alternately and evenly in the sequence illustrated (① - ⑤), more than 2 times with the wheel nut wrench, until they are tight.
4. Lower the vehicle slowly until the tire touches the ground.
5. Tighten the wheel nuts securely, with the wheel nut wrench, in the sequence illustrated.
6. Lower the vehicle completely.

Tighten the wheel nuts to the specified torque with a torque wrench as soon as possible.

**Wheel nut tightening torque:
108 N-m (11 kg-m, 80 ft-lb)**

The wheel nuts must be kept tightened to specification at all times. It is recommended that the wheel nuts be tightened to specification at each lubrication interval.



WARNING:

Retighten the wheel nuts when the vehicle has been driven for 1,000 km (600 miles) (also in cases of a flat tire, etc.).

STOWING DAMAGED TIRE AND TOOLS



WARNING:

Be sure that the tire, jack and tools used are properly stored after use. Such items can become dangerous projectiles in an accident or sudden stop.

1. Securely store the jack, tools and the damaged tire in the storage area.
2. Replace the cargo floor board.
3. Close the back door.

JUMP STARTING



WARNING:

- **Incorrect jump starting can lead to a battery explosion. The battery explosion may result in severe injury or death. It may also result in damage to the vehicle. Be sure to follow the instructions in this section.**
- **Explosive hydrogen gas is always present in the vicinity of the battery. Keep all sparks and flames away from the battery.**
- **Always wear suitable eye protection and remove rings, bracelets, and any other jewelry whenever working on or near a battery.**
- **Never lean over the battery while jump starting.**
- **Never allow battery fluid to come into contact with eyes, skin, clothes or the vehicle's painted surfaces. Battery fluid is a corrosive sulfuric acid which can cause severe burns. If the fluid comes into contact with anything, immediately flush the contacted area with plenty of water.**
- **Keep the battery out of the reach of children.**
- **The booster battery must be rated at 12 volts. Use of an incorrectly rated battery will damage your vehicle.**
- **Never attempt to jump start a frozen battery. It could explode and cause serious injury.**

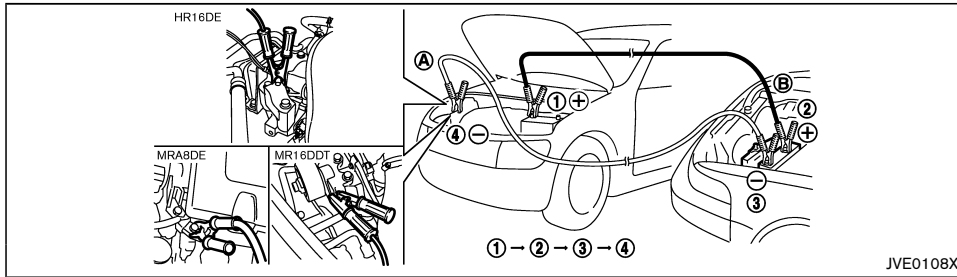

1. If the booster battery is in another vehicle (B), position the two vehicles (A) and (B) to bring the batteries into close proximity to each other.

⚠ CAUTION:

If the battery of vehicle (A) equipped with the Intelligent Key system is discharged, the ignition switch cannot be moved from the “LOCK” position and, if the steering lock is engaged, the steering wheel cannot be moved. Connect the jumper cables to the booster vehicle (B) before turning the ignition switch and disengaging the steering lock.

2. Apply the parking brake.
3. Continuously Variable Transmission (CVT) model: Move the shift lever to the “P” (Park) position.
Manual Transmission (MT) model: Move the shift lever to the “N” (Neutral) position.
4. Switch off all unnecessary electrical systems (headlights, heater, air conditioner, etc.).
5. Place the ignition switch in the “LOCK” position.

6. Remove the vent caps, if equipped, on the battery.
7. Cover the battery with a firmly wrung out moist cloth to reduce the hazard of an explosion.
8. Connect the jumper cables in the sequence as illustrated (1, 2, 3, 4).

⚠ CAUTION:

- Always connect positive ⊕ to positive ⊕ and negative ⊖ to body ground, NOT to the battery’s negative ⊖.
 - Be sure that the jumper cables do not touch moving parts in the engine compartment.
 - Be sure that the jumper cable’s clamps do not contact any other metal.
9. Start the engine of the booster vehicle (B) and let it run for a few minutes.
 10. Depress the accelerator pedal of the booster vehicle (B) at about 2,000 rpm.
 11. Start the engine of the jumped vehicle (A) in the normal manner.

⚠ CAUTION:

Never keep the starter motor engaged for more than 10 seconds. If the engine does not start right away, place the ignition switch in the “OFF” position and wait at least 10 seconds before trying again.

12. After the engine is started, carefully disconnect the jumper cables in the opposite sequence from that illustrated ((4), (3), (2), (1)).
13. Remove and dispose of the cloth as it may be contaminated with corrosive acid.
14. Replace the vent caps, if removed.

PUSH STARTING

Do not attempt to start the engine by pushing the vehicle.



CAUTION:

- **Continuously Variable Transmission (CVT)/ Manual Transmission (MT) model cannot be started by pushing. Attempting to do so may cause damage to the transmission.**
- **Three-way catalyst equipped model should not be started by pushing. Attempting to do so may cause damage to the catalyst.**
- **Never try to start the engine by towing. When the engine starts, the forward surge could cause the vehicle to collide with the towing vehicle.**

IF YOUR VEHICLE OVERHEATS



WARNING:

- **Never continue driving if your vehicle overheats. Doing so could cause a vehicle fire.**
- **Never open the hood if steam is coming out.**
- **Never remove the radiator or coolant reservoir cap while the engine is hot. If the radiator or coolant reservoir cap is removed when the engine is hot, pressurized hot water will spurt out and possibly cause burning, scalding or serious injury.**
- **If steam or coolant is coming from the engine, stand clear of the vehicle to prevent getting burned.**
- **The engine cooling fan will start at anytime when the coolant temperature exceeds preset degrees.**
- **Be careful not to allow your hands, hair, jewelry or clothing to come into contact with, or to get caught in the cooling fan or drive belts.**

If your vehicle is overheating (indicated by the high temperature indicator), or if you feel a lack of engine power, detect unusual noise, etc., take the following steps:

1. Safely move the vehicle off the road away from traffic.
2. Turn on the hazard indicator flasher lights.
3. Apply the parking brake.
4. Continuously Variable Transmission (CVT) model: Move the shift lever to the "P" (Park) position.
Manual Transmission (MT) model: Move the shift lever to the "N" (Neutral) position.

DO NOT STOP THE ENGINE.

5. Open all the windows.
6. Turn off the air conditioner. Move the temperature control to maximum hot and the fan control to high speed.
7. Get out from the vehicle.
8. Visually inspect and listen for steam or coolant escaping from the radiator before opening the hood. Wait until no steam or coolant can be seen before proceeding.
9. Open the engine hood.
10. Visually inspect if the cooling fan is running.
11. Visually inspect the radiator and radiator hoses for leakage.
If the cooling fan is not running or the coolant is leaking, stop the engine.
12. After the engine cools down, check the coolant level in the reservoir with the engine running. **Do not open the radiator cap.**
13. Add coolant to the reservoir if necessary.

Have your vehicle inspected/repaired at a NISSAN dealer.

TOWING YOUR VEHICLE

When towing your vehicle, local regulations for towing must be followed. Incorrect towing equipment could damage your vehicle. To assure proper towing and to prevent accidental damage to your vehicle, NISSAN recommends that you have professional road assistance personnel tow your vehicle. It is advisable to have the professional road assistant carefully read the following precautions.

TOWING PRECAUTIONS

- Be sure that the transmission, steering system, and drivetrain are in working condition before towing. If any units are damaged, the vehicle must be towed using a dolly or flatbed tow truck.
- NISSAN recommends that your vehicle be towed with the driving (front) wheels off the ground.
- Always attach safety chains before towing.

TOWING RECOMMENDED BY NISSAN

Two-Wheel Drive (2WD) models

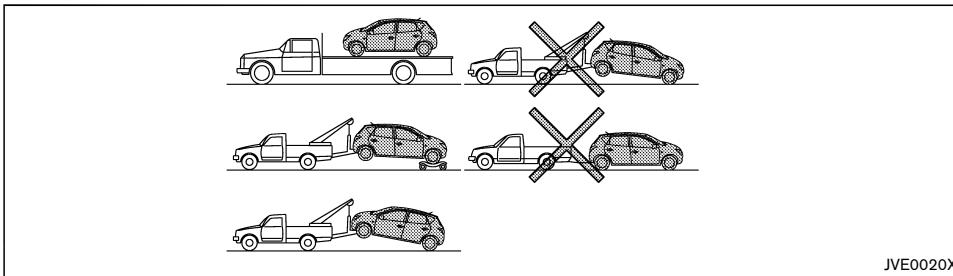

NISSAN recommends that towing dollies be used under the front wheels when towing your vehicle or the vehicle be placed on a flatbed tow truck as illustrated.

Front wheels on the ground:



CAUTION:

Never tow Continuously Variable Transmission (CVT) model with the front wheels on the ground. Doing so will cause serious and expensive damage to the drivetrain.

Manual Transmission (MT) model:

1. Place the ignition switch in the "OFF" position.
2. Secure the steering wheel in a straight ahead position with rope or a similar device.
3. Move the shift lever to the "N" (Neutral) position.
4. Release the parking brake.
5. Attach safety chains whenever towing.

Rear wheels on the ground:

1. Place the ignition switch to the "OFF" position.
2. Secure the steering wheel in a straight-ahead position with rope or a similar device.
3. Move the shift lever to the "N" (Neutral) position.
4. Release the parking brake.
5. Attach safety chains whenever towing.

All four wheels on the ground:



CAUTION:

Never tow CVT model with all four wheels on the ground. Doing so will cause serious and expensive damage to the transmission.

Manual Transmission (MT) model:

1. Place the ignition switch in the "OFF" position.
2. Move the shift lever to the "N" (Neutral) position.
3. Release the parking brake.

Freeing trapped vehicle

WARNING:

- **Never allow anyone to stand near the towing line during the pulling operation.**
- **Never spin the tires at high speed. This could cause them to explode and result in serious injury. Parts of the vehicle could also over-heat and be damaged.**
- **Do not pull the vehicle using the rear hook. The rear hook is not designed to pull the vehicle out in the event that the vehicle becomes trapped.**

In the event that your vehicle's tires become trapped in sand, snow, or mud, and the vehicle is unable to free itself without being pulled, use the recovery hooks.

- Use the recovery hooks only. Do not attach the pulling device to any other part of the vehicle body. Otherwise, the vehicle body may be damaged.
- Use the recovery hooks to free a vehicle only.
- The recovery hooks are under tremendous stress when used to free a trapped vehicle. Always pull the pulling device straight out from the vehicle. Never pull on the recovery hooks at an angle.

Front:

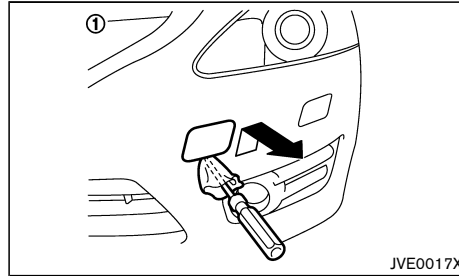

Front

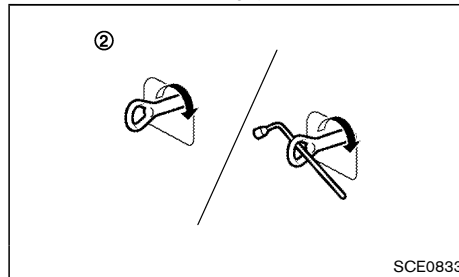

Front

- ① Remove the hook cover from the bumper with a suitable tool.
- ② Securely install the recovery hook as illustrated. (The hook is stored with the jacking tools.)

Make sure that the recovery hook is properly secured in its storage area after use.

Rear:

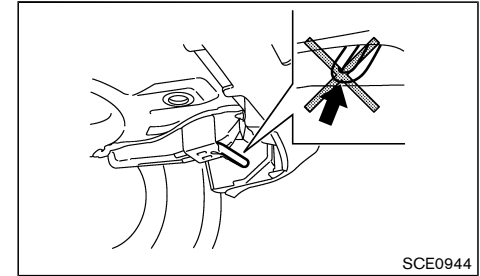

Rear

Do not use the rear hook to pull the vehicle.

MEMO

7 Appearance and care

Cleaning exterior	7-2	Cleaning interior	7-3
Washing	7-2	Air fresheners	7-4
Removing spots	7-2	Floor mats	7-4
Waxing	7-2	Glass	7-4
Glass	7-2	Seat belts	7-4
Underbody	7-3	Corrosion protection	7-5
Wheels	7-3	Most common factors contributing to vehicle corrosion	7-5
Aluminum alloy wheels	7-3	Environmental factors influence rate of corrosion	7-5
Chrome parts	7-3	To protect your vehicle from corrosion	7-5



CLEANING EXTERIOR

In order to maintain the appearance of your vehicle, it is important to take proper care of it.

Whenever possible, park your vehicle inside a garage or in a covered area to minimize the chances of damaging the paint surface of your vehicle.

When it is necessary to park outside, park in a shady area or protect the vehicle with a body cover. **Be careful not to scratch the paint surface when putting on or removing the body cover.**

WASHING

In the following instances, wash your vehicle as soon as possible to protect the paint surface:

- After a rainfall, which may cause the paint surface damage from acid rain.
 - After driving on coastal roads, which may cause rusting from the sea breeze.
 - When contaminants such as soot, bird droppings, tree sap, metal particles or bugs get on the paint surface.
 - When dust or mud builds up on the paint surface.
1. Wash the vehicle surface with a wet sponge and plenty of water.
 2. Clean the vehicle surface gently and thoroughly using a mild soap, a special vehicle soap or a general purpose dishwashing liquid mixed with clean, lukewarm (never hot) water.



CAUTION:

- **Do not wash the vehicle with strong household soap, strong chemical detergents, gasoline or solvents.**
- **Do not wash the vehicle in direct sunlight or while the vehicle body is hot, as the paint surface may become water-spotted.**

- **Avoid using tight-napped or rough cloths, such as washing mitts. Care must be taken when removing caked-on dirt or other foreign substances so the paint surface is not scratched or damaged.**
3. Rinse the vehicle thoroughly with plenty of clean water.
 4. Use a dampened chamois to dry the paint surface and avoid leaving water spots.

When washing the vehicle, take care of the following:

- Inside flanges, joints and folds on the doors, hatches and hood are particularly vulnerable to the effects of road salt. Therefore, these areas must be cleaned regularly.
- Be sure that the drain holes in the lower edge of the doors are not clogged.
- Spray water to the underbody and in the wheel wells to loosen the dirt and/or wash away road salt.

REMOVING SPOTS

Remove tar and oil spots, industrial dust, insects, and tree sap as quickly as possible from the paint surface to avoid lasting damage or staining. Special cleaning products are available at a NISSAN dealer or any automotive accessory store.

WAXING

Regular waxing protects the paint surface and helps maintain a new vehicle appearance.

After waxing, polishing is recommended to remove built-up residue and to avoid a weathered appearance.

A NISSAN dealer can assist you in choosing the appropriate waxing products.



CAUTION:

- **Wash your vehicle thoroughly and completely before applying wax to the paint surface.**
- **Always follow the manufacturer's instructions supplied with the wax.**
- **Do not use a wax containing any abrasives, cutting compounds or cleaners that may damage the vehicle finish.**

Machine compounding or aggressive polishing on a base coat/clear coat paint finish may dull the finish or leave swirl marks.

GLASS

Use glass cleaner to remove smoke and dust film from the glass surfaces. It is normal for glass to become coated with a film after the vehicle is parked in the hot sun. Glass cleaner and a soft cloth will easily remove this film.

UNDERBODY

In areas where road salt is used in the winter, it is necessary to clean the vehicle's underbody regularly in order to prevent dirt and salt from building up and causing the acceleration of corrosion on the underbody and suspension.

Before the winter and again in the spring, the underseal must be checked and, if necessary, re-treated.

WHEELS

- Wash the wheels when washing the vehicle to maintain their appearance.
- Clean the inner side of the wheels when the wheel is changed or the underside of the vehicle is washed.
- Do not use abrasive cleaners when washing the wheels.
- Inspect wheel rims regularly for dents or corrosion. This may cause loss of pressure or damage the tire bead.
- NISSAN recommends that the road wheels be waxed to protect against road salt in areas where it is used during winter.

ALUMINUM ALLOY WHEELS

Wash the wheels regularly with a sponge dampened in a mild soap solution, especially during winter in areas where road salt is used. The salt residue from road salt could discolor the wheels if it is not washed off regularly.



CAUTION:

Follow the directions below to avoid staining or discoloring the wheels:

- **Do not use a cleaner that uses strong acid or alkali contents to clean the wheels.**
- **Do not apply wheel cleaners to the wheels when they are hot. The wheel temperature should be the same as ambient temperature.**
- **Rinse the wheel to completely remove the cleaner within 15 minutes after the cleaner is applied.**

CHROME PARTS

Clean all chrome parts regularly with a nonabrasive chrome polish to maintain the finish.

CLEANING INTERIOR

Occasionally remove loose dust from the interior trim, plastic parts and seats using a vacuum cleaner or soft bristled brush. Wipe the vinyl and leather surfaces with a clean, soft cloth dampened in mild soap solution, then wipe clean with a dry, soft cloth.

Regular care and cleaning is required in order to maintain the appearance of the leather.

Before using any fabric protector, read the manufacturer's recommendations. Some fabric protectors contain chemicals that may stain or bleach the seat material.

Use a soft cloth dampened only with water to clean the meter and gauge lens covers.



CAUTION:

- **Never use benzine, thinner or any similar material.**
- **Small dirt particles can be abrasive and damaging to leather surfaces and should be removed promptly. Do not use saddle soap, car waxes, polishes, oils, cleaning fluids, solvents, detergents or ammonia-based cleaners as they damage the natural leather finish.**
- **Never use fabric protectors unless recommended by the manufacturer.**
- **Do not use glass or plastic cleaner on meter or gauge lens covers. It may damage the lens covers.**

AIR FRESHENERS

Most air fresheners use a solvent that could affect the vehicle interior. If you use an air freshener, take the following precautions:

- Hanging-type air fresheners can cause permanent discoloration when they contact vehicle interior surfaces. Place the air freshener in a location that allows it to hang free and not contact an interior surface.
- Liquid-type air fresheners typically clip on the vents. These products can cause immediate damage and discoloration when spilled on interior surfaces.

Carefully read and follow the manufacturer's instructions before using air fresheners.

FLOOR MATS

The use of genuine NISSAN floor mats (if equipped) can extend the life of your vehicle carpet and make it easier to clean the interior. Regardless of what mats are used, be sure they are fitted for your vehicle and are properly positioned in the foot well to prevent interference with pedal operation. Mats should be maintained with regular cleaning and replaced if they become excessively worn.

Floor mat positioning aid (driver's side)

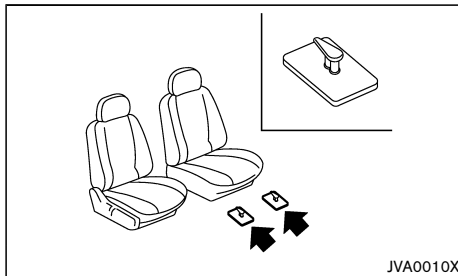

Example (LHD model)

This vehicle includes front floor mat brackets to act as a floor mat positioning aid. NISSAN floor mats have been specially designed for your vehicle model.

Position the mat by placing the floor mat bracket hook through the floor mat grommet hole while centering the mat in the foot area.

Periodically check that the mats are properly positioned.

GLASS

Use glass cleaner to remove smoke and dust film from the glass surfaces. It is normal for glass to become coated with a film after the vehicle is parked in the hot sun. Glass cleaner and a soft cloth will easily remove this film.



CAUTION:

When cleaning the inside of the windows, do not use sharp-edged tools, abrasive cleaners or chlorine-based disinfectant cleaners. They could damage the electrical conductors, such as rear window defogger elements.

SEAT BELTS



WARNING:

- **Do not allow wet seat belts to roll up in the retractor.**
- **Never use bleach, dye or chemical solvents to clean the seat belts, since these materials may severely weaken the seat belt webbing.**

The seat belts can be cleaned by wiping them with a sponge dampened in a mild soap solution.

Allow the belts to dry completely in the shade before using them. (See "Seat belts" (P.1-7).)

CORROSION PROTECTION

MOST COMMON FACTORS CONTRIBUTING TO VEHICLE CORROSION

- The accumulation of moisture-retaining dirt and debris in body panel sections, cavities, and other areas.
- Damage to the paint surface and other protective coatings caused by gravel and stone chips or minor traffic accidents.

ENVIRONMENTAL FACTORS INFLUENCE RATE OF CORROSION

Moisture

The accumulation of sand, dirt and water on the inside floor of the vehicle can accelerate corrosion. Wet floor carpet/floor mats will not dry completely inside the vehicle. They should be removed and completely dried to avoid floor panel corrosion.

Relative humidity

Corrosion will be accelerated in areas of high relative humidity.

Temperature

High temperatures accelerate the rate of corrosion to those parts which are not well ventilated.

Corrosion will also be accelerated in areas where the temperatures stay above freezing.

Air pollution

Industrial pollution, the presence of salt in the air in coastal areas, or heavy road salt use accelerates the corrosion process. Road salt also accelerates the disintegration of paint surfaces.

TO PROTECT YOUR VEHICLE FROM CORROSION

- Wash and wax your vehicle often to keep the vehicle clean.
- Always check for minor damage to the paint surface and if any exists, repair it as soon as possible.
- Keep the drain holes in the lower edge of the doors open to avoid water accumulation.
- Check the vehicle underbody for accumulation of sand, dirt or salt. If present, wash with water as soon as possible.



CAUTION:

- **Never remove dirt, sand or other debris from the passenger compartment by washing it out with a hose. Remove dirt with a vacuum cleaner.**
- **Never allow water or other liquids to come in contact with electronic components inside the vehicle as this may damage them.**

Chemicals used for road surface deicing are extremely corrosive. They accelerate corrosion and deterioration of underbody components such as the exhaust system, fuel and brake lines, brake cables, floor pan and fenders.

In the winter, the underbody must be cleaned periodically.

For additional protection against rust and corrosion, which may be required in some areas, consult a NISSAN dealer.

MEMO

8 Maintenance and do-it-yourself

Maintenance requirements	8-2	Wiper blades	8-15
Scheduled maintenance	8-2	Windshield wiper blades	8-15
General maintenance	8-2	Rear window wiper blade	8-16
Where to go for service	8-2	Window washer fluid	8-17
General maintenance	8-2	Battery	8-18
Explanation of general maintenance items	8-2	Vehicle battery	8-18
Maintenance precautions	8-4	Remote controller battery	8-19
Engine compartment check locations	8-5	Intelligent Key battery	8-20
MRA8DE engine model	8-5	Variable voltage control system (if equipped)	8-21
MR16DDT engine model	8-6	Fuses	8-21
HR16DE engine model	8-7	Engine compartment	8-21
Engine cooling system	8-7	Passenger compartment	8-22
Checking engine coolant level	8-8	Lights	8-23
Changing engine coolant	8-8	Headlights	8-23
Engine oil	8-9	Exterior lights	8-24
Checking engine oil level	8-9	Interior light	8-24
Changing engine oil and oil filter	8-9	Light locations	8-25
Drive belt	8-11	Legal requirement to adjust headlight beam (Halogen headlight model)	8-29
Spark plugs	8-12	Tires and wheels	8-31
Iridium platinum-tipped spark plugs (if equipped)	8-12	Tire inflation pressure	8-31
Platinum alloy-tipped spark plugs (if equipped)	8-12	Types of tires	8-31
Brakes	8-12	Tire chains	8-31
Checking parking brake	8-12	Tire rotation	8-31
Checking foot brake pedal	8-12	Tire wear and damage	8-32
Brake booster	8-13	Tire age	8-32
Brake fluid	8-13	Changing tires and wheels	8-32
Clutch fluid (if equipped)	8-14	Wheel balance	8-32
Continuously Variable Transmission (CVT) fluid (if equipped)	8-15	Spare tire	8-32
Air cleaner filter	8-15		

MAINTENANCE REQUIREMENTS

Some day-to-day and regular maintenance is essential to maintain your vehicle's good mechanical condition, as well as its emission and engine performance.

It is the owner's responsibility to make sure that the specified maintenance, as well as general maintenance, is performed.

As the vehicle owner, you are the only one who can ensure that your vehicle receives the proper maintenance care.

SCHEDULED MAINTENANCE

For your convenience, the required scheduled maintenance items are described and listed in a separate maintenance booklet. You must refer to that booklet to ensure that necessary maintenance is performed on your vehicle at regular intervals.

GENERAL MAINTENANCE

General maintenance includes those items which should be checked during normal day-to-day operation of the vehicle. They are essential if your vehicle is to continue to operate properly. It is your responsibility to perform these procedures regularly as prescribed.

Performing general maintenance checks requires minimal mechanical skill and a few general automotive tools.

These checks or inspections can be done by yourself, a qualified technician, or if you prefer, your NISSAN dealer.

WHERE TO GO FOR SERVICE

If maintenance service is required or your vehicle appears to malfunction, have the systems checked and tuned by an authorised NISSAN dealer.

GENERAL MAINTENANCE

During normal day-to-day operation of the vehicle, general maintenance should be performed regularly as prescribed in this section. If you detect any unusual sounds, vibrations or smells, be sure to check for the cause or have a NISSAN dealer do it promptly. In addition, you should notify a NISSAN dealer if you think that repairs are required.

When performing any checks or maintenance work, closely observe "Maintenance precautions" (P.8-4).

EXPLANATION OF GENERAL MAINTENANCE ITEMS

Additional information on the following items with "*" is found later in this section.

Outside vehicle

The maintenance items listed here should be performed from time to time, unless otherwise specified.

Doors and hood:

Check that all doors and the hood operate smoothly as well as the back door, trunk lid and hatch. Also make sure that all latches lock securely. Lubricate if necessary. Make sure that the secondary latch keeps the hood from opening when the primary latch is released. When driving in areas using road salt or other corrosive materials, check lubrication frequently.

Lights*:

Clean the headlights on a regular basis. Make sure that the headlights, stop lights, tail lights, turn signal lights, and other lights are all operating properly and installed securely. Also check the aim of the headlights.

Tires*:

Check the pressure with a gauge often and always prior to long distance trips. Adjust the pressure in all tires, including the spare, to the pressure specified. Check carefully for damage, cuts or excessive wear.

Tire rotation*:

In the case that Two-Wheel Drive (2WD) and front & rear tires are same size; Tires should be rotated every 10,000 km (6,000 miles). Tires marked with directional indicators can only be rotated between front and rear. Make sure that the directional indicators point in the direction of wheel rotation after the tire rotation is completed.

In the case that Four-Wheel Drive (4WD) and front & rear tires are same size; Tires should be rotated every 5,000 km (3,000 miles). Tires marked with directional indicators can only be rotated between front and rear. Make sure that the directional indicators point in the direction of wheel rotation after the tire rotation is completed.

In the case that front tires are different size from rear tires; Tires cannot be rotated.

However, the timing for tire rotation may vary according to your driving habits and the road surface conditions.

Tire Pressure Monitoring System (TPMS) transmitter components (if equipped):

Replace the TPMS transmitter grommet seal, valve core and cap when the tires are replaced due to wear or age.

Wheel alignment and balance:

If the vehicle should pull to either side while driving on a straight and level road, or if you detect uneven or abnormal tire wear, there may be a need for wheel alignment. If the steering wheel or seat vibrates at normal highway speeds, wheel balancing may be

needed.

Windshield:

Clean the windshield on a regular basis. Check the windshield at least every six months for cracks or other damage. Repair as necessary.

Wiper blades*:

Check for cracks or wear if not functioning correctly.

Inside vehicle

The maintenance items listed here should be checked on a regular basis, such as when performing periodic maintenance, cleaning the vehicle, etc.

Accelerator pedal:

Check the pedal for smooth operation and make sure that the pedal does not catch or require uneven effort. Keep the floor mats away from the pedal.

Brake pedal*:

Check the pedal for smooth operation and make sure that it is the proper distance from the floor mat when depressed fully. Check the brake booster function. Be sure to keep the floor mats away from the pedal.

Parking brake*:

Check the parking brake operation regularly. Check that the lever (if equipped) or the pedal (if equipped) has the proper travel. Also make sure that the vehicle is held securely on a fairly steep hill when only the parking brake is applied.

Seat belts:

Check that all parts of the seat belt system (for example, buckles, anchors, adjusters and retractors) operate properly and smoothly, and are installed securely. Check the belt webbing for cuts, fraying, wear or damage.

Steering wheel:

Check for changes in the steering condition, such as excessive play, hard steering or strange noises.

Warning lights and chimes:

Make sure that all warning lights and chimes are operating properly.

Windshield defogger:

Check that the air comes out of the defogger outlets properly and in good quantity when operating the heater or air conditioner.

Windshield wiper and washer*:

Check that the wipers and washer operate properly and that the wipers do not streak.

Under hood and vehicle

The maintenance items listed here should be checked periodically (for example, each time you check the engine oil or refuel).

Battery*:

Except for maintenance free battery, check the fluid level in each cell. It should be between the "UPPER" and "LOWER" lines. Vehicles operated in high temperatures or under severe conditions require frequent checks of the battery fluid level.

Brake (and clutch) fluid level(s)*:

For Manual Transmission (MT) model; make sure that the brake and clutch fluid levels are between the "MAX" and "MIN" lines on the reservoirs.

Except for Manual Transmission (MT) model; make sure that the brake fluid level is between the "MAX" and "MIN" lines on the reservoir.

Coolant level*:

Check the coolant level when the coolant is cold. Make sure that the coolant level is between the “MAX” and “MIN” lines on the reservoir.

Engine drive belt(s)*:

Make sure that drive belt(s) is/are not frayed, worn, cracked or oily.

Engine oil level*:

Check the level after parking the vehicle (on a level ground) and turning off the engine.

Fluid leaks:

Check under the vehicle for fuel, oil, water or other fluid leaks after the vehicle has been parked for a while. Water dripping from the air conditioner after use is normal. If you should notice any leaks or if fuel fumes are evident, check for cause and have it corrected immediately.

Windshield washer fluid*:

Check that there is adequate fluid in the reservoir.

MAINTENANCE PRECAUTIONS

When performing any inspection or maintenance work on your vehicle, always take care to prevent serious accidental injury to yourself or damage to the vehicle. The following are general precautions which should be closely observed.



WARNING:

- **Park the vehicle on a level surface, apply the parking brake securely and block the wheels to prevent the vehicle from moving. Move the shift lever to the “P” (Park) position (CVT model) or the shift lever to the “N” (Neutral) position (MT model).**

- **Be sure the ignition switch is in the “OFF” or “LOCK” position when performing any parts replacement or repairs.**
- **Do not work under the hood while the engine is hot. Always turn off the engine and wait until it cools down.**
- **If you must work with the engine running, keep your hands, clothing, hair and tools away from moving fans, belts and any other moving parts.**
- **It is advisable to secure or remove any loose clothing and any jewelry, such as rings, watches, etc. before working on your vehicle.**
- **If you must run the engine in an enclosed space such as a garage, be sure there is proper ventilation for exhaust gases to escape.**
- **Never get under the vehicle while it is supported by a jack.**
- **Keep smoking materials, flame and sparks away from fuel and the battery.**
- **Never connect or disconnect either the battery or any transistorized component connector while the ignition switch is in the “ON” position.**
- **On gasoline engine models with the Multi-port Fuel Injection (MFI) system, the fuel filter and fuel lines should be serviced by a NISSAN dealer because the fuel lines are under high pressure even when the engine is turned off.**
- **Your vehicle is equipped with an automatic engine cooling fan. It may come on at any time without warning, even if the ignition**

switch is in the “OFF” position and the engine is not running. To avoid injury, always disconnect the negative battery cable before working near the fan.

- **Always wear eye protection whenever you work on your vehicle.**
- **Never leave the engine or transmission related component harness connector disconnected while the ignition switch is in the “ON” position.**
- **Avoid direct contact with used engine oil and coolant. Improperly disposed engine oil, engine coolant, and/or other vehicle fluids can hurt the environment. Always conform to local regulations for disposal of vehicle fluids.**

This “8. Maintenance and do-it-yourself” section provides instructions regarding only those items which are relatively easy for an owner to perform.

You should be aware that incomplete or improper servicing may result in operating difficulties or excessive emissions, and could affect your warranty coverage. **If in doubt about any servicing, have it done by a NISSAN dealer.**

ENGINE COMPARTMENT CHECK LOCATIONS

MRA8DE ENGINE MODEL

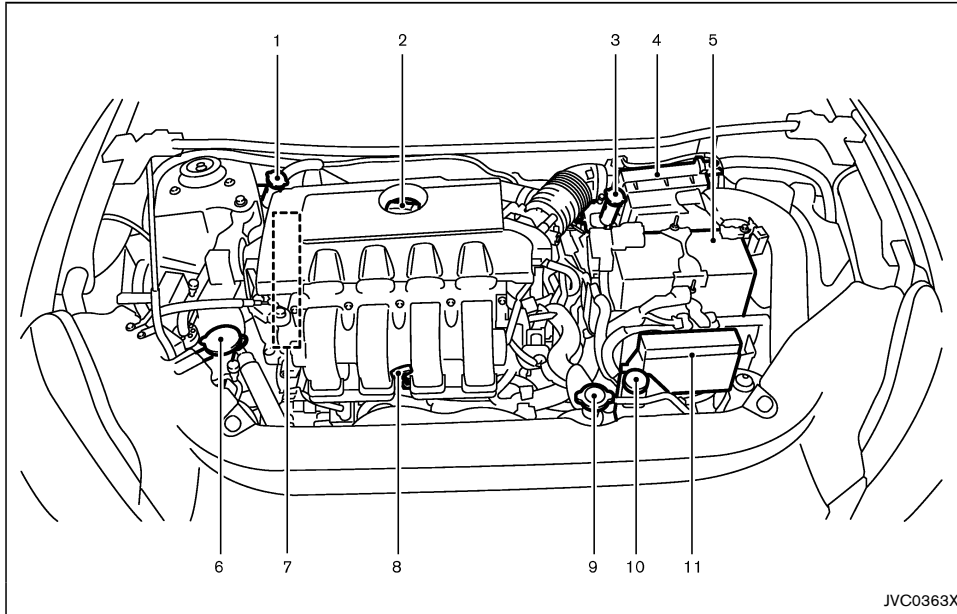

JVC0363X

- | | |
|---|---------------------------------------|
| 1. Brake and clutch* fluid reservoir
— Right-Hand Drive (RHD) models | 6. Window washer fluid reservoir |
| 2. Engine oil filler cap | 7. Engine drive belt location |
| 3. Brake fluid reservoir
— Left-Hand Drive (LHD) models | 8. Engine oil dipstick |
| 4. Air cleaner | 9. Radiator cap
— Vehicle overheat |
| 5. Battery
— Jump starting | 10. Engine coolant reservoir |
| | 11. Fuse/fusible link holders |

*: For Manual Transmission (MT) models

MR16DDT ENGINE MODEL

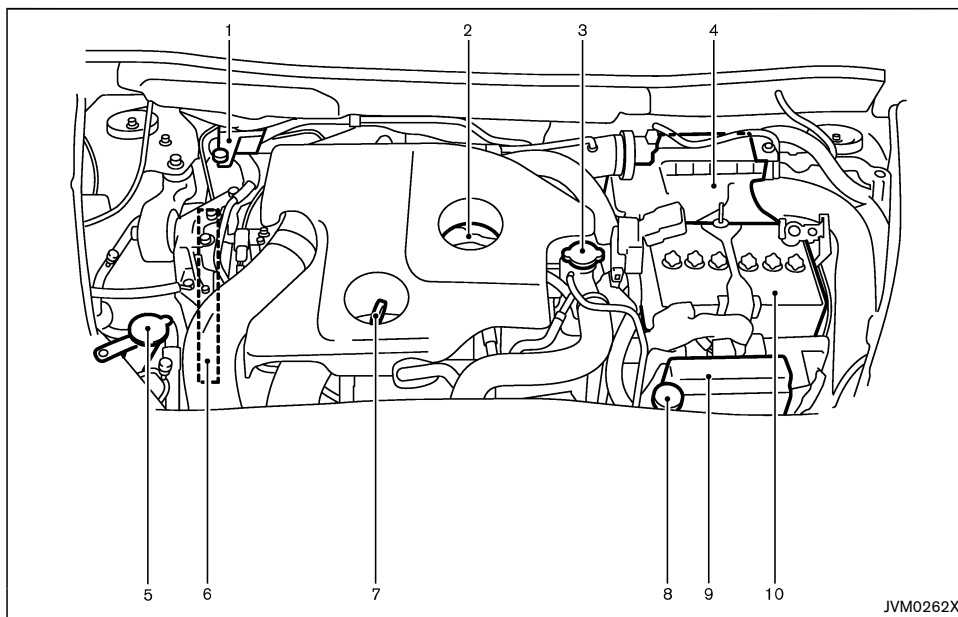

1. Brake and clutch* fluid reservoir
2. Engine oil filler cap
3. Radiator cap
— Vehicle overheat
4. Air cleaner
5. Window washer fluid reservoir
6. Engine drive belt location
7. Engine oil dipstick

8. Engine coolant reservoir
9. Fuse/fusible link holder
10. Battery
— Jump starting

*: For Manual Transmission (MT) model

ENGINE COOLING SYSTEM

HR16DE ENGINE MODEL

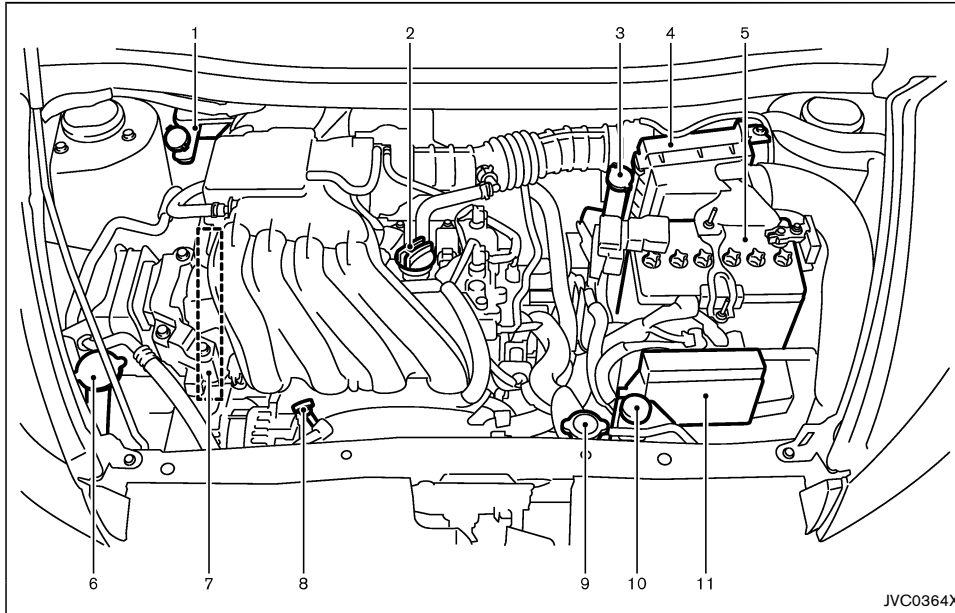

- | | |
|---|---------------------------------------|
| 1. Brake and clutch* fluid reservoir
— Right-Hand Drive (RHD) models | 6. Window washer fluid reservoir |
| 2. Engine oil filler cap | 7. Engine drive belt location |
| 3. Brake and clutch* fluid reservoir
— Left-Hand Drive (LHD) models | 8. Engine oil dipstick |
| 4. Air cleaner | 9. Radiator cap
— Vehicle overheat |
| 5. Battery
— Jump starting | 10. Engine coolant reservoir |
| | 11. Fuse/fusible link holders |
- *: For Manual Transmission (MT) models



WARNING:

- Never remove the radiator or coolant reservoir cap when the engine is hot. Serious burns could be caused by high-pressure fluid escaping from the radiator. Wait until the engine and radiator cool down.
- Engine coolant is poisonous and should be stored carefully in marked containers out of the reach of children.
- If the engine was stopped soon when the engine is hot, the cooling fan may operate for approximately 10 minutes after the engine was stopped to cool the components in the engine compartment. When the cooling fan is operating, be sure that hands or other items do not get caught in it (for MR16DDT engine).

The engine cooling system is filled at the factory with a high-quality, year-round, anti-freeze coolant solution. The anti-freeze solution contains rust and corrosion inhibitors, therefore additional cooling system additives are not necessary.



CAUTION:

- Never use any cooling system additives such as radiator sealer. Additives may clog the cooling system and cause damage to the engine, transmission and/or cooling system.
- When adding or replacing coolant, be sure to use only Genuine NISSAN Engine Coolant or equivalent in its quality with the proper mixture ratio. Examples of the mixture ratio of coolant and water are shown in the following table:

Outside temperature down to		Engine coolant (concentrated)	Demineralized or distilled water
°C	°F		
-15	5	30%	70%
-35	-30	50%	50%

The use of other types of coolant solutions may damage the engine cooling system.

The radiator is equipped with a pressure cap. To prevent engine damage, use only a Genuine NISSAN radiator cap or its equivalent when replacement is required.

CHECKING ENGINE COOLANT LEVEL

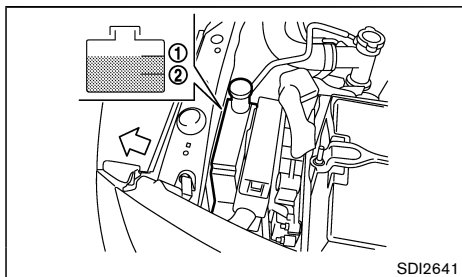

MR16DDT engine model

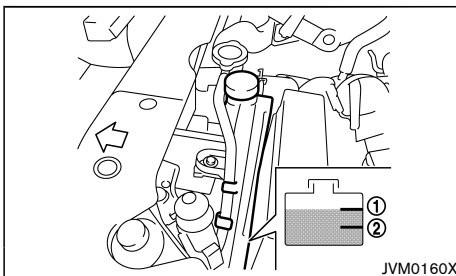

MRA8DE and HR16DE engine model

Check the coolant level in the reservoir tank when the engine is cold. If the coolant level is below the MIN level ②, add coolant up to the MAX level ①. If the reservoir tank is empty, check the coolant level in the radiator **when the engine is cold**. If there is insufficient coolant in the radiator, fill the radiator with coolant up to the filler opening and also add it to the reservoir tank up to the MAX level ①.

If the cooling system frequently requires coolant, have it checked by a NISSAN dealer.

CHANGING ENGINE COOLANT

Contact a NISSAN dealer if replacement is required.

Major engine cooling system repair should be performed by a NISSAN dealer. The service procedures can be found in the appropriate NISSAN Service Manual.

Improper servicing can result in reduced heater performance and engine overheating.



WARNING:

- To avoid being scalded, never change the coolant when the engine is hot.

- Never remove the radiator or coolant reservoir cap when the engine is hot. Serious burns could be caused by high pressure fluid escaping from the radiator.
- Avoid direct skin contact with used coolant. If skin contact is made, wash thoroughly with soap or hand cleaner as soon as possible.
- Keep coolant out of the reach of children and pets.

Engine coolant must be disposed of properly. Check your local regulations.

ENGINE OIL

CHECKING ENGINE OIL LEVEL

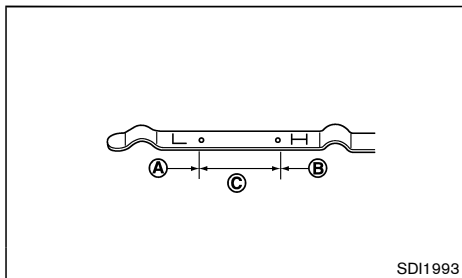

Type A

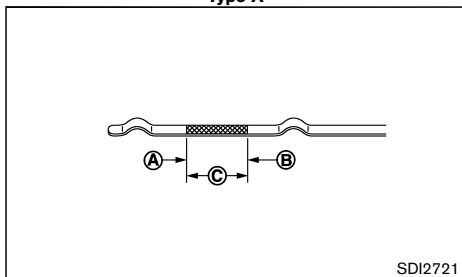

Type B

1. Park the vehicle on a level surface and apply the parking brake.
2. Start the engine and warm it up until the engine temperature reaches the normal operating temperature (approximately 5 minutes).
3. Stop the engine.
4. Wait at least 10 minutes for the engine oil to drain back to the oil pan.
5. Remove the dipstick and wipe it clean.

6. Reinsert the dipstick all the way.
7. Remove the dipstick and check the oil level. It should be within the range (C) .
8. If the oil level is below (A) , remove the oil filler cap and pour the recommended oil into the opening. Do not overfill (B) .

When filling the engine oil, do not remove the dipstick.

9. Recheck the oil level with the dipstick.

It is normal to add some oil between oil maintenance intervals or during the break-in period, depending on the severity of operating conditions.



CAUTION:

The oil level should be checked regularly. Operating your vehicle with an insufficient amount of oil can damage the engine, and such damage is not covered by the warranty.

CHANGING ENGINE OIL AND OIL FILTER



WARNING:

- **Used oil must be disposed of properly. Never pour or dump oil into the ground, canals, rivers, etc. It should be disposed of at proper waste facilities. NISSAN recommends having your oil changed by a NISSAN dealer.**
- **Be careful not to burn yourself, as the engine oil may be hot.**
- **Prolonged and repeated contact with used engine oil may cause skin cancer.**
- **Avoid direct skin contact with used oil. If contacted, wash thoroughly with soap or**

hand cleaner and plenty of water as soon as possible.

- **Store used engine oil in marked containers out of the reach of children.**

1. Park the vehicle on a level surface and apply the parking brake.
2. Start the engine and warm it up until the engine temperature reaches the normal operating temperature (approximately 5 minutes).
3. Stop the engine.
4. Wait at least 10 minutes for the engine oil to drain back to the oil pan.
5. Raise and support the vehicle using a suitable floor jack and safety jack stands.
 - Place the safety jack stands under the vehicle jack-up points.
 - A suitable adapter should be attached to the jack stand saddle.
6. For HR16DE engine model, remove the plastic engine undercover.
 - Remove the bolts and plastic clips from the undercover.

Engine oil and filter

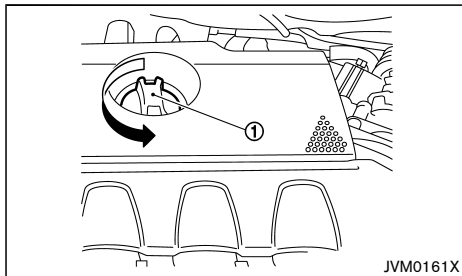

MR8DE engine model

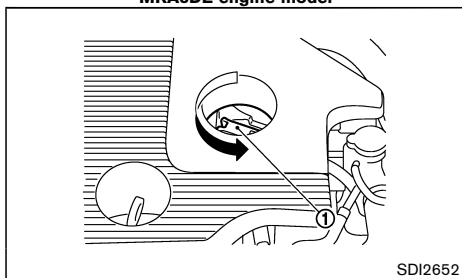

MR16DDT engine model

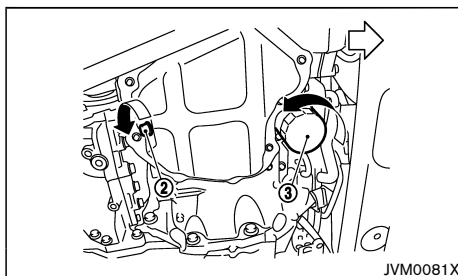

MR8DE and MR16DDT engine model

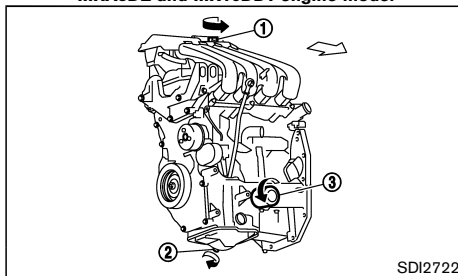

HR16DE engine model

- ① Oil filler cap
- ② Oil drain plug
- ③ Oil filter

1. Place a large drain pan under the drain plug.
2. Remove the drain plug with a wrench.
3. Remove the oil filler cap and completely drain the oil.

If the oil filter is to be changed, remove and replace it at this time.



CAUTION:

Waste oil must be disposed of properly. Check your local regulations.

4. Loosen the oil filter with an oil filter wrench.
5. Remove the oil filter by turning it by hand.
6. Wipe the engine oil filter mounting surface with a clean cloth.

Be sure to remove any old gasket remaining on the mounting surface.

7. Apply new engine oil to the gasket of the new oil filter.
8. Screw in the oil filter until a slight resistance is felt and then tighten an additional 2/3 of a turn to secure the filter.

Oil filter tightening torque:

**15 to 20 N-m
(1.5 to 2.0 kg-m, 11 to 15 ft-lb)**

9. Clean and reinstall the drain plug and new washer. Securely tighten the drain plug with a wrench. Do not use excessive force.

Drain plug tightening torque:

**29 to 39 N-m
(3.0 to 4.0 kg-m, 22 to 29 ft-lb)**

10. Refill the recommended engine oil and quantity. (See "Recommended fluids/lubricants and capacities" (P.9-2).)

When filling the engine oil, do not remove the dipstick (except for HR16DE engine model).

11. Securely install the oil filler cap.

DRIVE BELT

12. Start the engine.
13. Check the drain plug for any sign of leakage.
14. Dispose of the used oil in the proper manner. Check your local regulations.
15. Check the engine oil level according to the proper procedure. (See "Checking engine oil level" (P.8-9).)

After the operation

1. For HR16DE engine model, install the engine undercover into position as the following steps.
 - a. Pull the center of the small plastic clip out.
 - b. Hold the engine undercover into position.
 - c. Insert the clip through the undercover into the hole in the frame, then push the center of the clip in to lock the clip in place.
 - d. Install the other bolts that hold the undercover in place. Be careful not to strip the bolts or over-tighten them.
2. Lower the vehicle carefully to the ground.
3. Dispose of waste oil and filter properly.

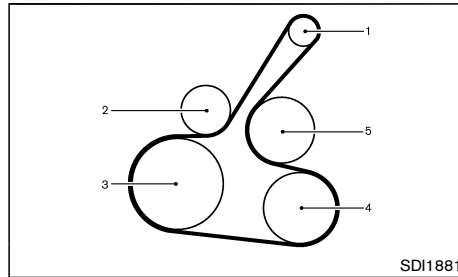

MRA8DE and MR16DDT engine model

1. Alternator
2. Drive belt auto-tensioner
3. Crankshaft pulley
4. Air conditioner compressor
5. Water pump

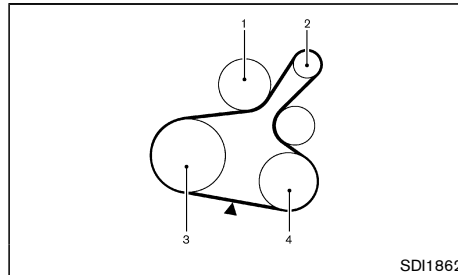

HR16DE engine model

1. Water pump
 2. Alternator
 3. Crankshaft pulley
 4. Air conditioner compressor
- ▼: Tension checking point

Be sure the ignition switch is in the "OFF" position.

Visually inspect the belt for signs of unusual wear, cuts, fraying or looseness. Regularly check the condition and tension (for HR16DE engine model). If the belt is in poor condition or loose, have it replaced or adjusted by a NISSAN dealer.

SPARK PLUGS

WARNING:

Be sure the engine and ignition switch are off and that the parking brake is applied.

Replace the spark plugs according to the maintenance log shown in a separate maintenance booklet.

If replacement is required, contact a NISSAN dealer.

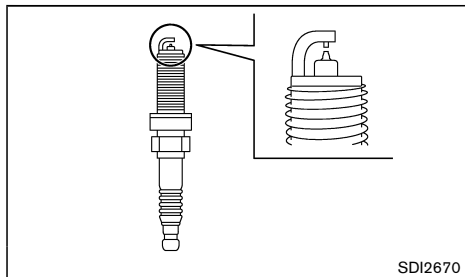

IRIDIUM PLATINUM-TIPPED SPARK PLUGS (if equipped)

It is not necessary to replace the iridium platinum-tipped spark plugs as frequently as the conventional type of spark plugs. These spark plugs are designed to last much longer than the conventional type of spark plugs.

CAUTION:

- **Do not reuse the iridium platinum-tipped spark plugs by cleaning or re-gapping.**
- **Always replace with the recommended iridium platinum-tipped spark plugs.**

PLATINUM ALLOY-TIPPED SPARK PLUGS (if equipped)

It is not necessary to replace the platinum alloy-tipped spark plugs as frequently as the conventional type of spark plugs. These spark plugs are designed to last much longer than the conventional type of spark plugs.

CAUTION:

- **Do not reuse the platinum alloy-tipped spark plugs by cleaning or re-gapping.**
- **Always replace with the recommended platinum alloy-tipped spark plugs.**

BRAKES

CHECKING PARKING BRAKE

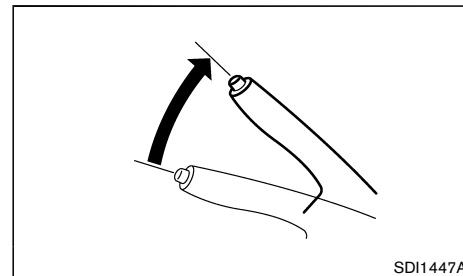

From the released position, pull the parking brake lever up slowly and firmly. If the number of clicks is out of the range listed, see a NISSAN dealer.

Pulling force
196 N (20 kg, 44 lb)

Rear disc brake models:
9 to 10 clicks

Rear drum brake models:
8 to 9 clicks

CHECKING FOOT BRAKE PEDAL

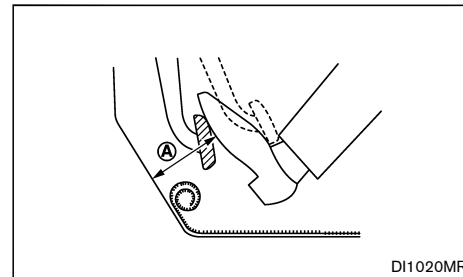



WARNING:

See a NISSAN dealer for a brake system check if the foot brake pedal height does not return to normal.

With the engine running, check the distance **(A)** between the upper surface of the pedal and the metal floor. If it is out the range listed, see a NISSAN dealer.

(A) : Depressing force
490 N (50 kg, 110 lb)

Rear drum brake models:
— 75 mm (2.95 in) or more (LHD models)

Rear disc brake models:
— 70 mm (2.76 in) or more (LHD models)
— 85 mm (3.35 in) or more (RHD models)

Self-adjusting brakes

Your vehicle is equipped with self-adjusting brakes. The disc-type brakes self-adjust every time the foot brake pedal is applied.

Brake pad wear warning

The disc brake pads have audible wear warnings. When a brake pad requires replacement, it will make a high pitched scraping sound when the vehicle is in motion. This scraping sound will first occur only when the brake pedal is depressed. After more wear of the brake pad, the sound will always be heard even if the brake pedal is not depressed. Have the brakes checked as soon as possible if the wear warning sound is heard.

Under some driving or climate conditions, occasional brake squeaks, squeals or other noises may be heard. Occasional brake noise during light to moderate stops is normal and does not affect the function or

performance of the brake system.

Proper brake inspection intervals should be followed. For additional information, see a separate maintenance booklet.

BRAKE BOOSTER

Check the brake booster function as follows:

1. With the engine off, depress and release the foot brake pedal several times. When the brake pedal movement (distance of travel) remains the same from one pedal application to the next, continue on to the next step.
2. While depressing the foot brake pedal, start the engine. The pedal height should drop a little.
3. With the foot brake pedal depressed, stop the engine. Keep the pedal depressed for about 30 seconds. The pedal height should not change.
4. Run the engine for 1 minute without depressing the foot brake pedal, then turn it off. Depress the foot brake pedal several times. The pedal travel distance will decrease gradually with each depression as the vacuum is released from the booster.

If the brakes do not operate properly, have the brakes checked by a NISSAN dealer.

BRAKE FLUID



WARNING:

- Use only new fluid from a sealed container. Old, inferior, or contaminated fluid may damage the brake system. The use of improper fluids can damage the brake system and affect the vehicle's stopping ability.
- Clean the filler cap before removing.
- Brake fluid is poisonous and should be stored carefully in marked containers out of the reach of children.



CAUTION:

Do not spill the fluid on painted surfaces. This will damage the paint. If fluid is spilled, wash it off with plenty of water immediately.

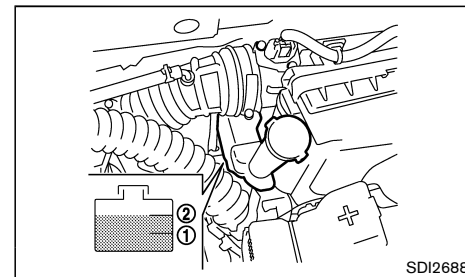

Left-Hand Drive (LHD) models

SDI2688

CLUTCH FLUID (if equipped)

WARNING:

- Use only new fluid from a sealed container. Old, inferior, or contaminated fluid may damage the clutch system.
- Clean the filler cap before removing.
- Clutch fluid is poisonous and should be stored carefully in marked containers out of the reach of children.

CAUTION:

Do not spill the clutch fluid on painted surfaces. This will damage the paint. If clutch fluid is spilled, wash it off with plenty of water immediately.

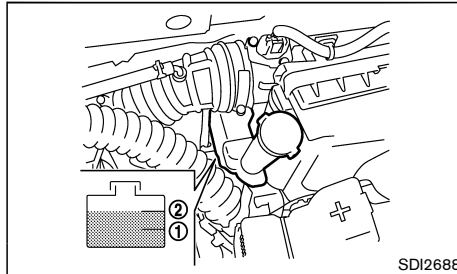

Left-Hand Drive (LHD) models

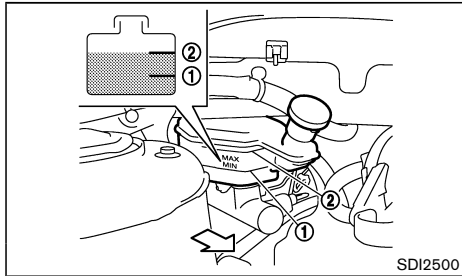

Right-Hand Drive (RHD) models

Check the fluid level in the reservoir. If the fluid is below the MIN line ①, the brake warning light will illuminate. Add fluid up to the MAX line ②. (For recommended types of fluid, see "Recommended fluids/lubricants and capacities" (P.9-2).)

If the fluid must be added frequently, the system should be thoroughly checked by a NISSAN dealer.

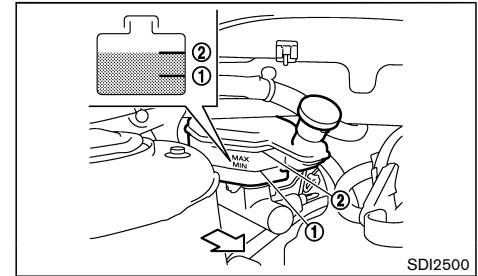

Right-Hand Drive (RHD) models

Check the fluid level in the reservoir. If the fluid is below the MIN line ①, add fluid up to the MAX line ②. (For recommended types of fluid, see "Recommended fluids/lubricants and capacities" (P.9-2).)

If the fluid must be added frequently, the clutch system should be thoroughly checked by a NISSAN dealer.

CONTINUOUSLY VARIABLE TRANSMISSION (CVT) FLUID (if equipped)

Contact a NISSAN dealer if checking or replacement is required.



CAUTION:

- Use only Genuine NISSAN CVT Fluid NS-3. Do not mix with other fluids.
- Using transmission fluid other than Genuine NISSAN CVT Fluid NS-3 will damage the CVT, which is not covered by the warranty.

AIR CLEANER FILTER

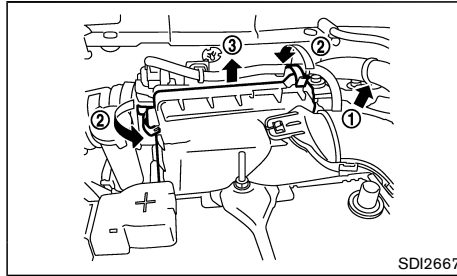

WARNING:

Operating the engine with the air cleaner filter off can cause you or others to be burned. The air cleaner filter not only cleans the intake air, it also stops flame if the engine backfires. If the air cleaner filter is not installed and the engine backfires, you could be burned. Never drive with the air cleaner filter off. Be cautious working on the engine when the air cleaner filter is off.

To remove the filter, pull the air duct ① upward to remove it. Pull the tabs ②, then pull the cover ③ upward.

The viscous paper type filter element should not be cleaned and reused. The dry paper type filter element may be cleaned and reused. Replace the air filter according to the maintenance log shown in a separate maintenance booklet.

When replacing the air filter, wipe the inside of the air cleaner housing and the cover with a damp cloth.

WIPER BLADES

WINDSHIELD WIPER BLADES

Cleaning

If the windshield does not become clear after using the windshield washer or if the wiper blades chatter when operating the windshield wipers, wax or other materials may be on the windshield and/or wiper blades.

Clean the outside of the windshield surface with a washer solution or mild detergent. Your windshield is clean if beads do not form when rinsing with water.

Clean the blade by wiping it with a cloth soaked in a washer solution or a mild detergent. Rinse the blade with water. If your windshield is still not clear after cleaning the blades and using the wipers, replace the blades.

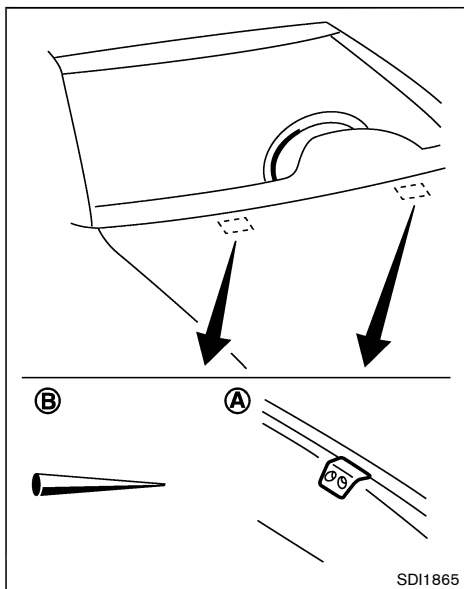

Be careful not to clog the washer nozzle (A). This may cause improper windshield washer operation. If the nozzle is clogged, remove any objects with a needle or small pin (B). Be careful not to damage the nozzle.

Replacing

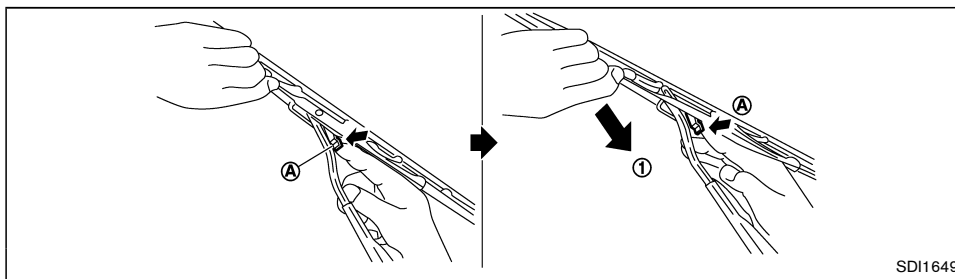

REAR WINDOW WIPER BLADE

Contact a NISSAN dealer if checking or replacement is required.

Replace the wiper blades if they are worn.

Before replacing the wiper blades, the wiper should be in the fully up position to avoid scratching the engine hood or damaging the wiper arm. To pull up the wiper arm, see "Wiper and washer switch" (P.2-20).

1. Lift the wiper arm away from the windshield.
2. Push and hold the release tab (A), and then move the wiper blade down the wiper arm to remove ①.
3. Remove the wiper blade.
4. Insert the new wiper blade onto the wiper arm until it clicks into place.

CAUTION:

- After wiper blade replacement, return the wiper arm to its original position. Otherwise the wiper arm or the engine hood may be scratched and may cause damage when the engine hood is opened.
- Worn wiper blades can damage the windshield and impair driver vision.

WINDOW WASHER FLUID

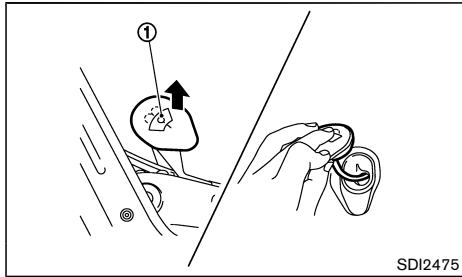

WARNING:







Anti-freeze is poisonous and should be stored carefully in marked containers out of the reach of children.

To check the fluid level, use your finger to plug the center hole ① of the cap/tube assembly, then remove it from the reservoir.

If there is no fluid in the tube, add fluid.

Add a washer solvent to the water for better cleaning. In the winter season, add a windshield washer anti-freeze. Follow the manufacturer's instructions for the mixture ratio.

BATTERY

Caution symbols for battery			 WARNING
①		No smoking, No exposed flames, No sparks	Never smoke around battery. Never expose battery to open flames or electrical sparks.
②		Shield eyes	Handle the battery cautiously. Always wear eye protection glasses to protect against explosion or battery acid.
③		Keep away from children	Never allow children to handle battery. Keep the battery out of the reach of children.
④		Battery acid	Do not allow battery fluid to contact your skin, eyes, fabrics, or painted surfaces. After handling the battery or battery cap, immediately wash your hands thoroughly. If the battery fluid gets into your eyes, or onto your skin or clothing, flush with water immediately for at least 15 minutes and seek medical attention. Battery fluid is acid. If the battery fluid gets into your eyes or onto your skin, it could cause loss of your eyesight or burns.
⑤		Note operating instructions	Before handling the battery, read this instruction carefully to ensure correct and safe handling.
⑥		Explosive gas	Hydrogen gas, generated by battery fluid, is explosive.

SD11573

VEHICLE BATTERY



WARNING:

Do not operate the vehicle if the fluid in the battery is low. Low battery fluid can cause a higher load on the battery which can generate heat, reduce battery life, and in some cases lead to an explosion.

Checking battery fluid level

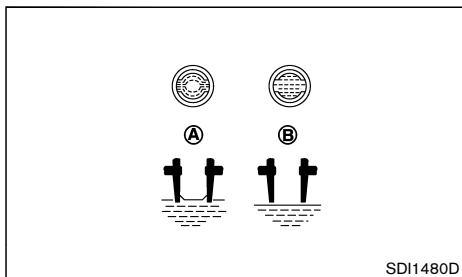
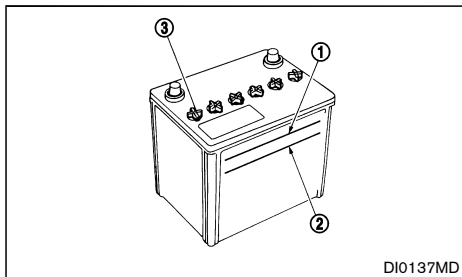

Check the fluid level in each cell. The battery fluid level should be between the UPPER LEVEL ① and LOWER LEVEL ② lines.

If it is necessary to add fluid, add only demineralized/distilled water to bring the level to the indicator in each filler opening. Do not overfill.

1. Remove the cell plugs ③ (if equipped) using a suitable tool.
2. Add demineralized/distilled water up to the UPPER LEVEL ① line.

If the side of the battery is not clear, check the

distilled water level by looking directly above the cell; the condition ① indicates OK and the condition ② needs more to be added.

3. Replace and tighten the cell plugs.
- Vehicles operated in high temperatures or under severe conditions require frequent checks of the battery fluid level.
 - Keep the battery surface clean and dry. Clean the battery with a solution of baking soda and water.
 - Make certain the terminal connections are clean and securely tightened.
 - If the vehicle is not to be used for more than 30 days, disconnect the negative (-) battery terminal cable to prevent battery discharge.

Jump starting

If jump starting is necessary, see "Jump starting" (P.6-5). If the engine does not start by jump starting or the battery does not charge, the battery may have to be replaced. Contact a NISSAN dealer for replacing the battery.

REMOTE CONTROLLER BATTERY

Battery replacement



CAUTION:

- **Be careful not to allow children to swallow the battery and removed parts.**
- **An improperly disposed battery can harm the environment. Always confirm local regulations for battery disposal.**
- **When changing batteries, do not let dust or oil get on the components.**

- **There is danger of explosion if lithium battery is incorrectly replaced. Replace only with the same or equivalent type.**
- **Do not expose the battery to excessive heat such as sunshine, fire, etc.**

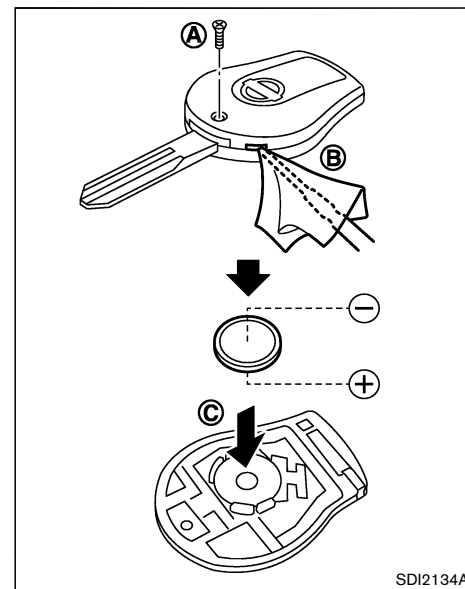

To replace the battery:

1. Remove the screw ①.
2. Insert a small screwdriver into the slit of the corner ② and twist it to separate the upper part from the lower part. Use a cloth to protect the casing.

3. Replace the battery with a new one.

Recommended battery: CR1620 or equivalent

- Do not touch the internal circuit and electric terminals as doing so could cause a malfunction.
- Make sure that the + side faces the bottom of the case (C).

4. Close the lid and install the screw securely.

5. Operate the buttons to check its operation.

See a NISSAN dealer if you need assistance for replacement.

INTELLIGENT KEY BATTERY

Battery replacement



CAUTION:

- **Be careful not to allow children to swallow the battery and removed parts.**
- **An improperly disposed battery can harm the environment. Always confirm local regulations for battery disposal.**
- **When changing batteries, do not let dust or oil get on the components.**
- **There is danger of explosion if lithium battery is incorrectly replaced. Replace only with the same or equivalent type.**
- **Do not expose the battery to excessive heat such as sunshine, fire, etc.**

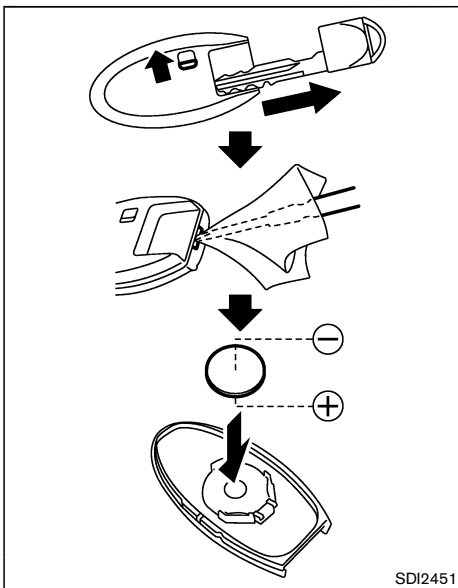

To replace the battery:

1. Release the lock knob at the back of the Intelligent Key and remove the mechanical key.
2. Insert a small screwdriver into the slit of the corner and twist it to separate the upper part from the lower part. Use a cloth to protect the casing.
3. Replace the battery with a new one.
 - Recommended battery: CR2025 or equivalent
 - Do not touch the internal circuit and electric terminals as doing so could cause a malfunction.

- Make sure that the ⊕ side faces the bottom of the case.

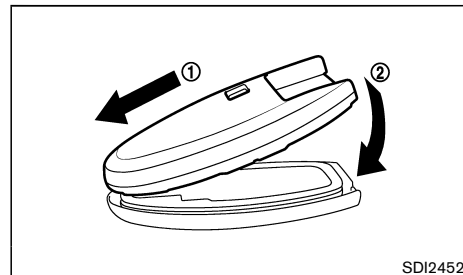

4. Align the tips of the upper and lower parts (1), and then push them together until it is securely closed (2).

5. Operate the buttons to check its operation.

See a NISSAN dealer if you need assistance for replacement.

VARIABLE VOLTAGE CONTROL SYSTEM (if equipped)



CAUTION:

- Do not ground accessories directly to the battery terminal. Doing so will bypass the variable voltage control system and the vehicle battery may not charge completely.
- Use electrical accessories with the engine running to avoid discharging the vehicle battery.

Your vehicle is equipped with a variable voltage control system. This system measures the amount of electrical discharge from the battery and controls voltage generated by the alternator.

FUSES

ENGINE COMPARTMENT

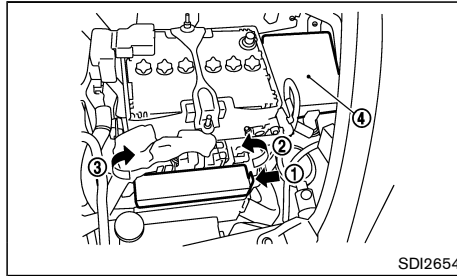

CAUTION:

Never use a fuse of a higher or lower amperage rating than that specified on the fuse box cover. This could damage the electrical system or cause a fire.

If any electrical equipment does not operate, check for an open fuse.

1. Be sure the ignition switch is in the "OFF" position.
2. Be sure the headlight switch is in the "OFF" position.
3. Open the engine hood.
4. Remove the fuse/fusible link box cover by pushing the tab ① and lifting the cover from the right side ②, then the left side ③.
5. Locate the fuse that needs to be replaced.

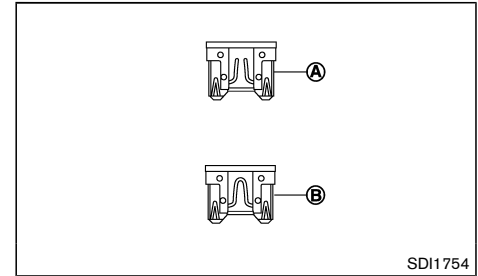

6. Remove the fuse using the fuse puller located in the passenger compartment.
7. If the fuse is open ①, replace it with a new fuse ②.

If the new fuse also opens, after installing, have the electrical system checked, and if necessary repaired, by a NISSAN dealer.

The holder ④ also contains the fuses. For checking and/or replacing, see a NISSAN dealer.

Fusible links

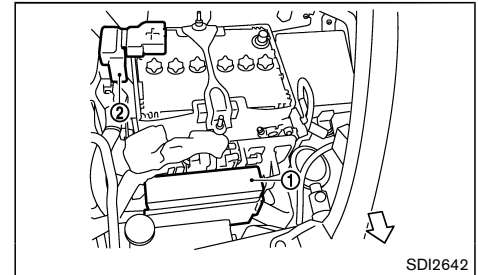

If any electrical equipment does not operate and the fuses are in good condition, check the fusible links in

the holders ① and ② . If any of these fusible links are melted, replace only with genuine NISSAN parts.

For checking and replacing the fusible links in holders ② , see a NISSAN dealer.

PASSENGER COMPARTMENT

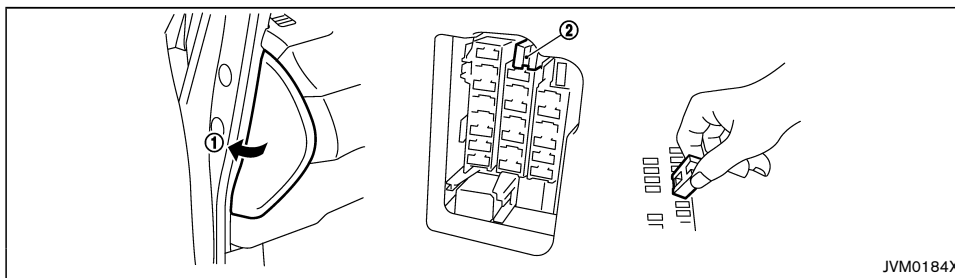

CAUTION:

Never use a fuse of a higher or lower amperage rating than that specified on the fuse box cover. This could damage the electrical system or cause a fire.

If any electrical equipment does not operate, check for an open fuse.

1. Be sure the ignition switch is in the "OFF" position.
2. Be sure the headlight switch is in the "OFF" position.
3. Remove the fuse box cover ① .
4. Locate the fuse that needs to be replaced.
5. Remove the fuse using the fuse puller ② .

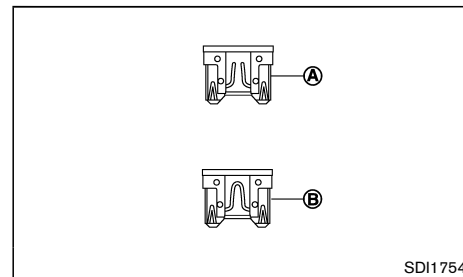

6. If the fuse is open ① , replace it with a new fuse ② .

If the new fuse also opens, after installing, have the electrical system checked, and if necessary repaired, by a NISSAN dealer.

Extended storage fuse switch (if equipped)

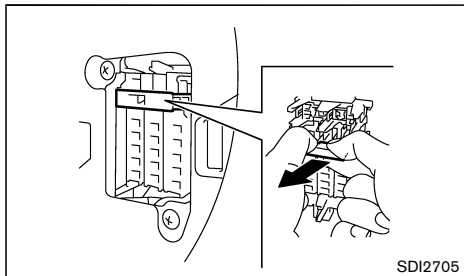

If any electrical equipment does not operate, remove the extended storage fuse switch and check for an open fuse.

NOTE:

If the extended storage fuse switch malfunctions, or if the fuse is open, it is not necessary to replace the switch. In this case, remove the extended storage fuse switch and replace it with a new fuse of the same rating.

How to remove the extended storage fuse switch:

1. To remove the extended storage fuse switch, be sure the ignition switch is in the "OFF" or "LOCK" position.
2. Be sure the headlight switch is in the "OFF" position.
3. Remove the fuse box cover.
4. Pinch the storage fuse switch and pull it in the direction illustrated.

LIGHTS

HEADLIGHTS

Fog may temporarily form inside the lens of the exterior lights in the rain or in a car wash. A temperature difference between the inside and the outside of the lens causes the fog. This is not a malfunction. If large drops of water collect inside the lens, contact a NISSAN dealer.

Xenon headlight model

If replacement is required, contact a NISSAN dealer.



WARNING:



HIGH VOLTAGE

When xenon headlights are on, they produce a high voltage. To prevent an electric shock, never attempt to modify or disassemble. Always have your xenon headlights replaced at a NISSAN dealer.

Use the same number and wattage as originally installed:

High/Low beams (Xenon)

Wattage: 35

Bulb no.: D2S

Halogen headlight model

The halogen headlight is a semi-sealed beam type which uses replaceable headlight (halogen) bulbs. They can be replaced from inside the engine compartment without removing the headlight assembly.



CAUTION:

High-pressure halogen gas is sealed inside the bulb. The bulb may break if the glass envelope is scratched or the bulb is dropped.

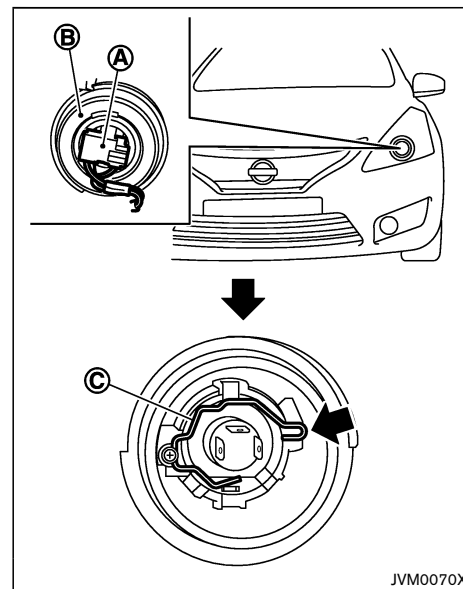

1. Disconnect the battery negative cable.
2. Disconnect the electrical connector (A) from the rear end of the bulb.
3. Pull off the rubber cap (B).
4. Push and turn the retaining pin (C) to loosen it.
5. Remove the headlight bulb. Do not shake or rotate the bulb when removing it.
6. Install the new bulb in the reverse order of removal.

**CAUTION:**

- **When handling the bulb, do not touch the glass envelope.**
- **Do not leave the bulb out of the headlight reflector for a long period of time as dust, moisture and smoke may enter the headlight body and affect the performance of the headlight.**

Use the same number and wattage as originally installed:

Halogen headlight model**High/Low beam bulb: 60W/55W (H4)**

Aiming adjustment is not necessary if only the bulbs are replaced. When aiming adjustment is necessary, contact a NISSAN dealer.

EXTERIOR LIGHTS

Item	Wattage (W)
Front turn signal light	21
Front clearance light	5
Front fog light (if equipped)	35
Side turn signal light	
Fender type	5
Outside rearview mirror type*	LED
Rear combination lights	
Turn signal	21
Stop/tail light	21/5
Reverse light	21
High-mounted stop light*	LED
License plate light	5

*: See a NISSAN dealer for replacement.

INTERIOR LIGHT

Item	Wattage (W)
Room light	8
Map light	8
Vanity mirror light (if equipped)	1.8
Cargo room light	5

LIGHT LOCATIONS

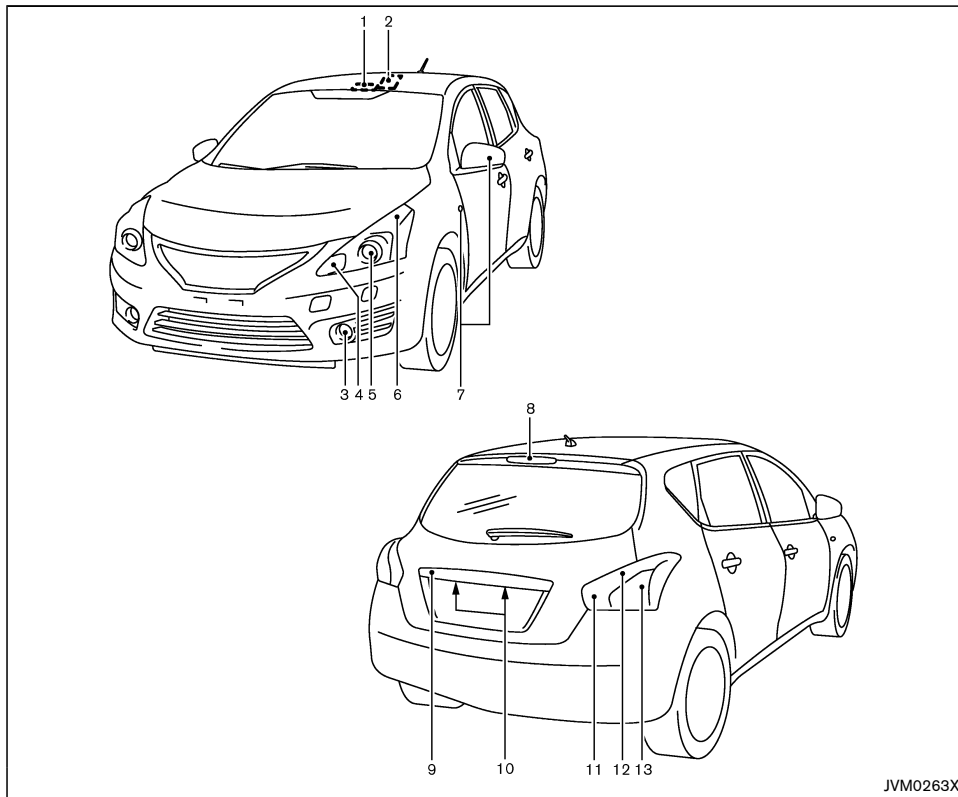

1. Map light
 2. Room light
 3. Front fog light*
 4. Front turn signal light
 5. Headlight (high-beam/low-beam)
 6. Clearance light
 7. Side turn signal lights (on the front fender or the outside rearview mirror)
 8. High-mounted stop light
 9. Cargo room light
 10. License plate light
 11. Reverse light
 12. Rear turn signal light
 13. Stop/tail light
- *: if equipped

Replacement procedures

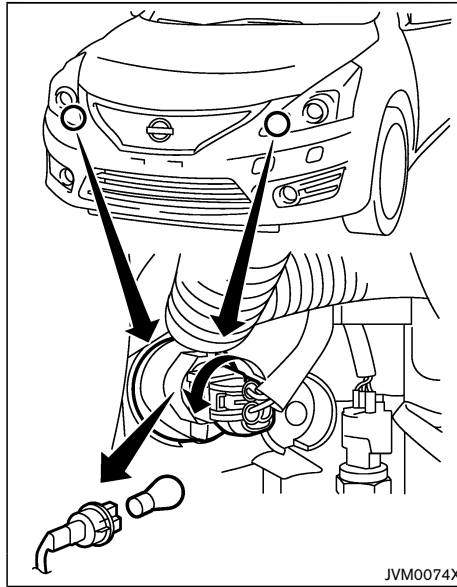
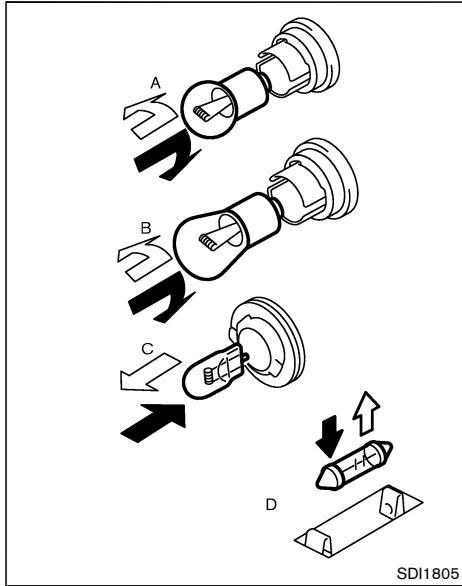

Front turn signal light

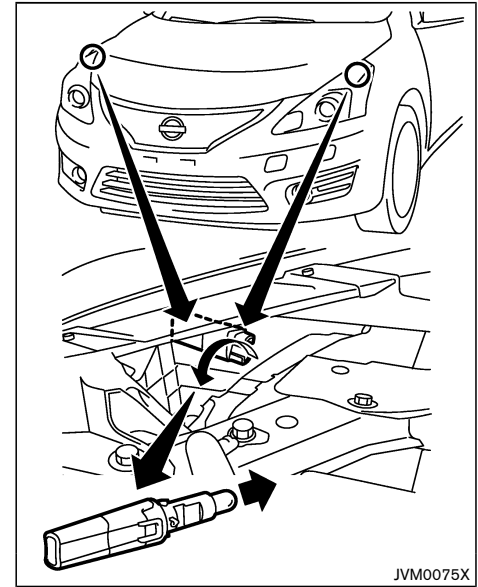

Clearance light

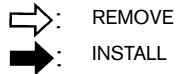

All other lights are either type A, B, C or D. When replacing a bulb, first remove the lens and/or cover.

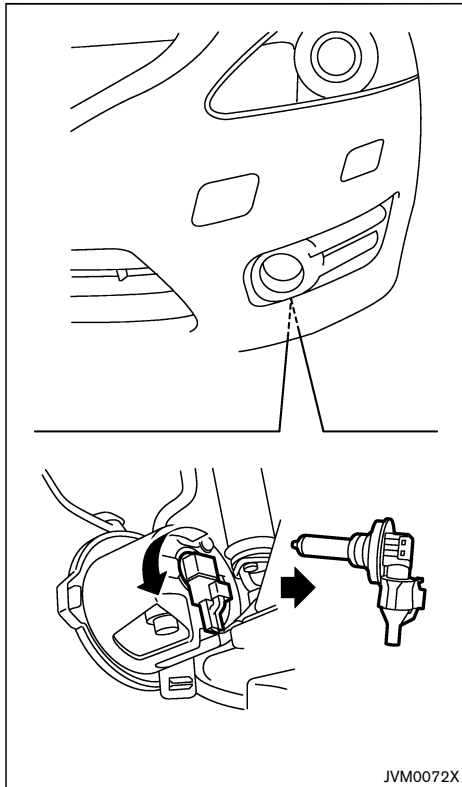

Front fog light (if equipped)

JVM0072X

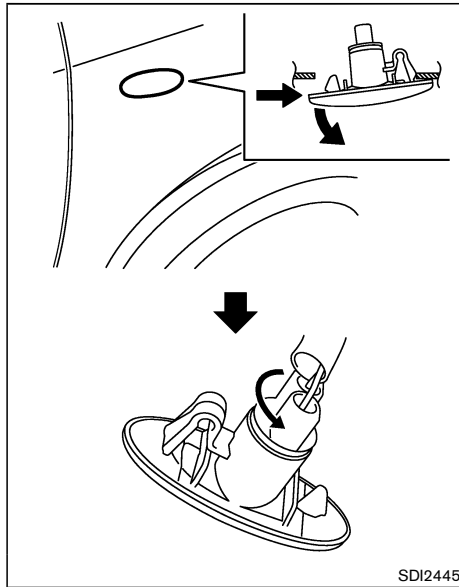

Side turn signal light (fender type)

SDI2445

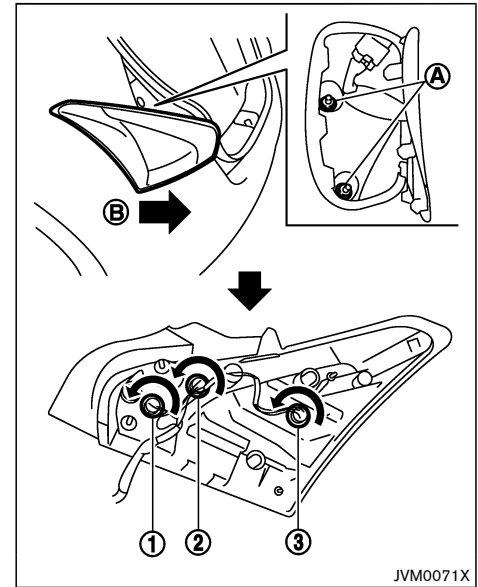

Rear combination light

JVM0071X

To replace the rear combination light bulbs:

1. Remove the nuts (A) and move the rear combination light (B) rearward to make a clearance, then carefully pry the light using a suitable tool.
2. Replace the bulbs. (Stop/tail light (3), Turn signal light (2), Reverse light (1))
3. Install the combination light in the reverse order of removal.

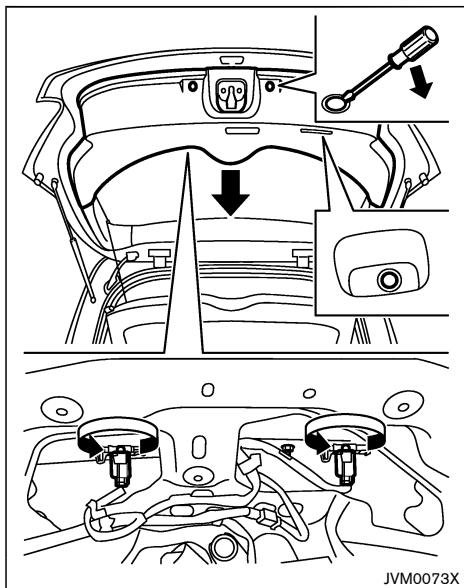

License plate light

JVM0073X

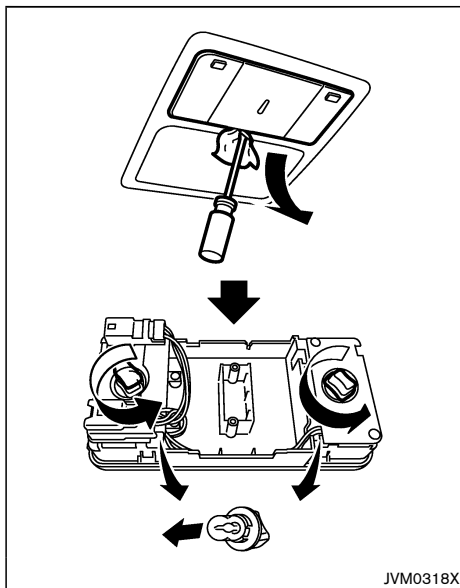

Map light

JVM0318X

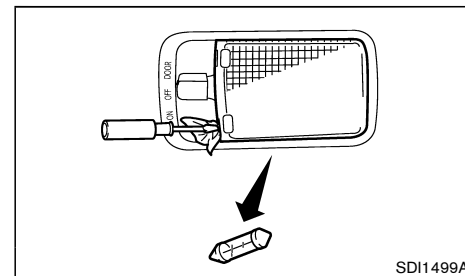

Room light

SDI1499A

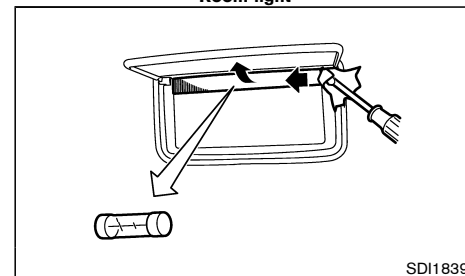

Vanity mirror light (if equipped)

SDI1839

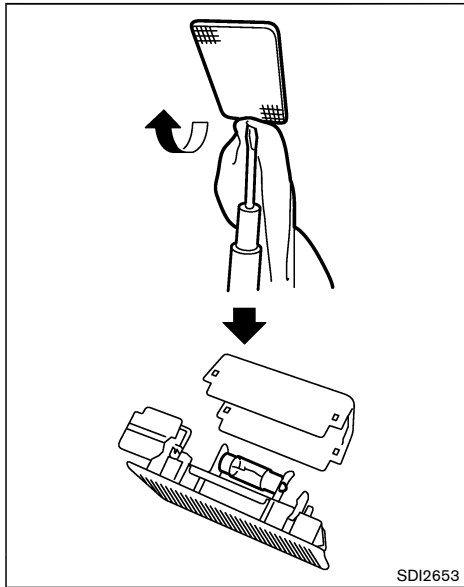

Cargo room light

SDI2653

LEGAL REQUIREMENT TO ADJUST HEADLIGHT BEAM (Halogen headlight model)

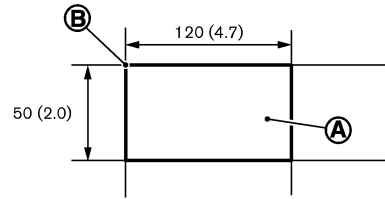
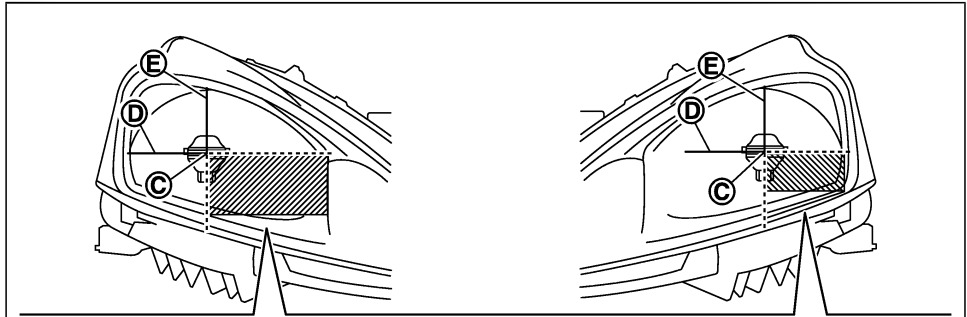

Units: mm (inch)

Left-Hand Drive (LHD) models

JVM0247X

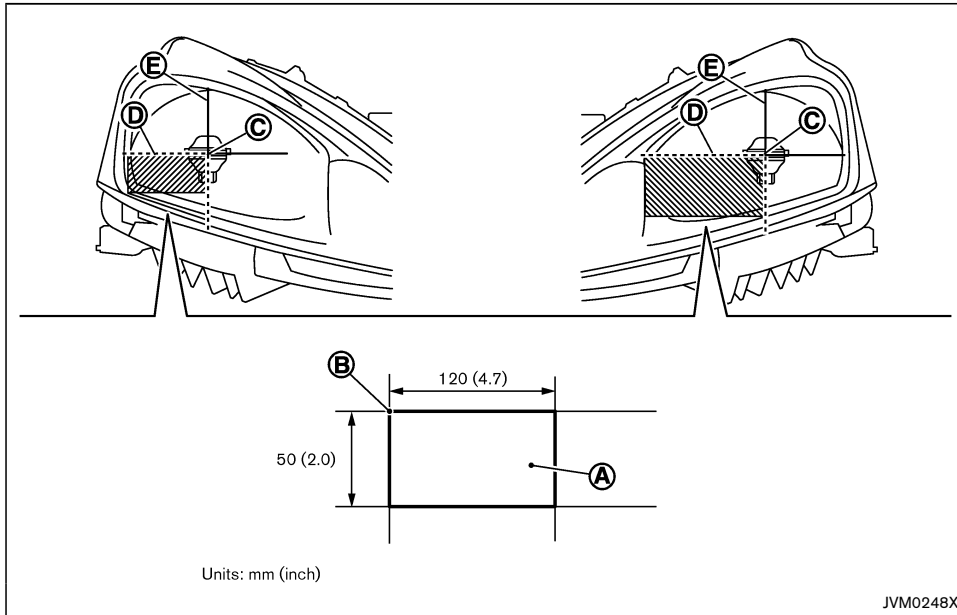

Right-Hand Drive (RHD) models

When the vehicle is driven in a country where the driving lane is different to your home country, affix an opaque sticker on the headlight.

1. Turn the ignition switch to the "OFF" position and wait until the headlights cool down.
2. Prepare the stickers referring to the figure. Make the stickers (A) that will be affixed to the surface of the right side headlight and the left side headlight.

NOTE:

- Use an opaque material that prevents the light from passing through it.
 - Note that other transparent materials do not work effectively.
3. Affix the sticker by aligning the corner (B) of the sticker with the position of the mark (C) that is located on the surface of the headlight seen from front.

Affix the sticker as illustrated by aligning the mark

(C) with dividing lines (D) and (E).

NOTE:

Align the mark (C) with the center mark of the headlight bulb.

TIRES AND WHEELS

If you have a flat tire, see "Flat tire" (P.6-2).

TIRE INFLATION PRESSURE

Periodically check the pressure of the tires, including the spare. An incorrect tire pressure may adversely affect tire life and vehicle handling. The tire pressure should be checked when tires are COLD. Tires are considered COLD after the vehicle has been parked for 3 or more hours, or driven less than 1.6 km (1 mile). COLD tire pressures are shown on the tire placard.

Insufficient pressure can lead to an overheating of the tire and subsequent internal damage. At high speeds, this could result in tread separation and even bursting of the tire.

TYPES OF TIRES



CAUTION:

When changing or replacing tires, be sure all four tires are of the same type (that is, summer, all season or snow) and construction. A NISSAN dealer may be able to help you with information about tire type, size, speed rating and availability.

Replacement tires may have a lower speed rating than the factory equipped tires, and they may not match the potential maximum vehicle speed. Never exceed the maximum speed rating of the tire.

All season tires

NISSAN specifies all season tires on some models to provide good performance all year, including snowy and icy road conditions. All season tires are identified by ALL SEASON and/or M&S on the tire sidewall. Snow tires have better snow traction than all season tires and may be more appropriate in some areas.

Summer tires

NISSAN specifies summer tires on some models to provide superior performance on dry roads. Summer tire performance is substantially reduced in snow and ice. Summer tires do not have the tire traction rating M&S on the tire sidewall.

If you plan to operate your vehicle in snowy or icy conditions, NISSAN recommends the use of snow or all season tires on all four wheels.

Snow tires

If snow tires are needed, it is necessary to select tires equivalent in size and load rating to the original equipment tires. If you do not, it can adversely affect the safety and handling of your vehicle.

Generally, snow tires have lower speed ratings than factory equipped tires and may not match the potential maximum vehicle speed. Never exceed the maximum speed rating of the tire. If you install snow tires, they must be the same size, brand, construction and tread pattern on all four wheels.

For additional traction on icy roads, studded tires may be used. However, some states and provinces prohibit their use. Check local, state and provincial laws before installing studded tires. Skid and traction capabilities of studded snow tires on wet or dry surfaces may be poorer than that of non-studded snow tires.

TIRE CHAINS

Use of tire chains may be prohibited according to location. Check the local laws before installing tire chains. When installing tire chains, make sure that they are of proper size for the tires on your vehicle and are installed according to the chain manufacturer's instructions.

Use chain tensioners when recommended by the tire chain manufacturer to ensure a tight fit. Loose end links of the tire chains must be secured or removed to prevent the possibility of whipping action damage to the fenders or underbody. If possible, avoid fully loading your vehicle when using tire chains. In addition, drive at a reduced speed. Otherwise, your vehicle may be damaged and/or vehicle handling and performance may be adversely affected.

Tire chains must be installed only on the front wheels and not on the rear wheels.

Do not drive with tire chains on paved roads which are clear of snow. Driving with chains in such conditions can cause damage to the various mechanisms of the vehicle due to some overstress.

TIRE ROTATION

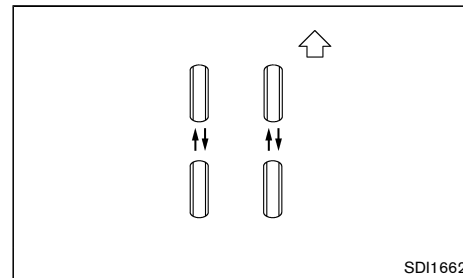

NISSAN recommends that tires be rotated every

10,000 km (6,000 miles). However, the timing for tire rotation may vary according to your driving habits and the road surface conditions. (For the tire replacement, see "Flat tire" (P.6-2).)

For models with 17-inch tire, tires marked with directional indicators can only be rotated between front and rear. Make sure that the directional indicators point in the direction of wheel rotation after the tire rotation is completed.

WARNING:

- **After rotating the tires, adjust the tire pressure.**
- **Retighten the wheel nuts when the vehicle has been driven for 1,000 km (600 miles) (also in cases of a flat tire, etc.).**
- **Do not include the spare tire in tire rotation.**
- **Incorrect tire selection, fitting, care, or maintenance can affect vehicle safety with risk of accident and injury. If in doubt, consult a NISSAN dealer or the tire manufacturer.**

TIRE WEAR AND DAMAGE

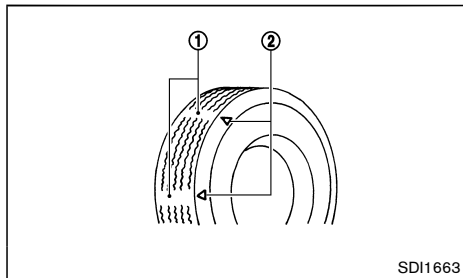

- ① Wear indicator
- ② Wear indicator location mark

Tires should be periodically inspected for wear, cracking, bulging or objects caught in the tread. If excessive wear, cracks, bulging or deep cuts are found, the tire should be replaced immediately.

The original tires have a built-in tread wear indicator. When the wear indicator is visible, the tire should be replaced.

Improper service of a spare tire may result in serious personal injury. If it is necessary to repair the spare tire, contact a NISSAN dealer.

TIRE AGE

Never use a tire over six years old, regardless of whether it has been used or not.

Tires degrade with age as well as with the vehicle usage. Have your tires checked and balanced often by a repair shop or, if you prefer, a NISSAN dealer.

CHANGING TIRES AND WHEELS

WARNING:

Do not install a deformed wheel or tire even if it has been repaired. Such wheels or tires could have structural damage and could fail without warning.

When replacing a tire, use the same size, speed rating and load carrying capacity as originally equipped. (For recommended types and sizes of tires and wheels, see "Tires and wheels" (P.9-7).) The use of tires other than those recommended or the mixed use of tires of different brands, construction (bias, bias-belted, or radial), or tread patterns can adversely affect the ride, braking, handling, ground clearance, body-to-tire clearance, snow chain clearance, speedometer cali-

bration, headlight aim and bumper height. Some of these effects may lead to accidents and could result in serious personal injury.

If the wheels are changed for any reason, always replace with wheels which have the same offset dimension. Wheels of a different offset could cause early tire wear, possibly degraded vehicle handling characteristics and/or interference with the brake discs/drums. Such interference can lead to decreased braking efficiency and/or early brake pad/shoe wear.

WHEEL BALANCE

Unbalanced wheels may affect vehicle handling and tire life. Even with regular use, wheels can get out of balance. Therefore, they should be balanced as required.

SPARE TIRE

Conventional spare tire

A standard tire (the same size as the road wheels) is supplied with your vehicle.

For models with 17-inch tires, mounting a spare tire with the directional indicators pointed against the direction of wheel rotation will not affect normal driving. However, in this case, you will need to replace the spare tire with a suitable regular tire as soon as possible.

9 Technical information

Recommended fluids/lubricants and capacities	9-2	Engine serial number	9-9
Fuel information	9-4	Certification label (if equipped)	9-9
Recommended SAE viscosity number	9-4	Tire placard	9-9
Air conditioner system refrigerant and lubricant	9-5	Air conditioner specification label	9-9
Engine	9-6	Uniform Tire Quality Grading (if equipped)	9-9
Tires and wheels	9-7	Treadwear	9-9
Dimensions	9-7	Traction AA, A, B and C	9-9
When travelling or registering in another country	9-8	Temperature A, B and C	9-10
Vehicle identification	9-8	Radio approval number and information	9-10
Vehicle identification plate	9-8	For Singapore	9-10
Vehicle Identification Number (VIN) plate (if equipped)	9-8	For Nigeria	9-10
Vehicle Identification Number (chassis number)	9-8	For Jordan	9-10

RECOMMENDED FLUIDS/ LUBRICANTS AND CAPACITIES

The following are approximate capacities. The actual refill quantities may be slightly different. When refilling, follow the procedures instructed in the "8. Maintenance and do-it-yourself" section to determine the proper refill capacity.

		Capacity (Approximate)		Recommended Fluids/Lubricants
		Liter	Imp measure	
Fuel		52	11-1/2 gal	See "Fuel information" (P.9-4).
Engine oil (Refill)				For changing engine oil, see "Engine oil" (P.8-9). <ul style="list-style-type: none"> • Genuine NISSAN engine oil • API grade SL, SM or SN • ILSAC grade GF-3, GF-4 or GF-5 For additional information, see "Recommended SAE viscosity number" (P.9-4).
MRA8DE	With oil filter	3.9	3-3/8 qt	
	Without oil filter	3.7	3-1/4 qt	
MR16DDT	With oil filter	4.5	4 qt	
	Without oil filter	4.3	3-3/4 qt	
HR16DE	With oil filter	3.0	2-5/8 qt	
	Without oil filter	2.8	2-1/2 qt	
Cooling system (with reservoir)				<ul style="list-style-type: none"> • Genuine NISSAN Engine Coolant or equivalent in its quality • Use Genuine NISSAN Engine Coolant or equivalent in its quality, in order to avoid possible aluminum corrosion within the engine cooling system caused by the use of non-genuine engine coolant. • Note that any repairs for the incidents within the engine cooling system while using non-genuine engine coolant may not be covered by the warranty even if such incidents occurred during the warranty period.
Total	MR16DDT	8.3	7-1/4 qt	
	HR16DE and MRA8DE	6.6	5-7/8 qt	
Reservoir		0.8	3/4 qt	
Continuously Variable Transmission (CVT) fluid		—	—	<ul style="list-style-type: none"> • Genuine NISSAN CVT Fluid NS-3 • Use only Genuine NISSAN CVT Fluid NS-3. Using transmission fluid other than Genuine NISSAN CVT Fluid NS-3 will damage the CVT, which is not covered by the warranty.
Manual Transmission (MT) gear oil				

	5-speed MT model	—	—	<ul style="list-style-type: none"> • Genuine NISSAN Manual Transmission Fluid (MTF) HQ Multi 75W-85 or equivalent • If Genuine NISSAN Manual Transmission Fluid (MTF) HQ Multi is not available, API GL-4, Viscosity SAE 75W-85 may be used as a temporary replacement. However, use Genuine NISSAN Manual Transmission Fluid (MTF) HQ Multi as soon as it is available.
	6-speed MT model	—	—	<ul style="list-style-type: none"> • Genuine NISSAN Manual Transmission Fluid (MTF) Chevron Texaco ETL 8997B 75W-80, or equivalent • If Genuine NISSAN Manual Transmission Fluid (MTF) Chevron Texaco ETL 8997B is not available, API GL-4, Viscosity SAE 75W-80 may be used as a temporary replacement. However, use Genuine NISSAN Manual Transmission Fluid (MTF) Chevron Texaco ETL 8997B as soon as it is possible.
Brake and clutch fluid	Refill to the proper fluid level according to the instructions in the "8. Maintenance and do-it-yourself" section.			Genuine NISSAN Brake Fluid, or equivalent DOT3
Multi-purpose grease		—	—	NLGI No. 2 (Lithium soap base)
Air conditioner system refrigerant		—	—	HFC-134a (R-134a)
Air conditioner system lubricants				
	MRA8DE	—	—	NISSAN A/C System Oil Type S or equivalent
	MR16DDT and HR16DE	—	—	NISSAN A/C System Oil Type R or equivalent

FUEL INFORMATION



CAUTION:

Do not use leaded gasoline. Using leaded gasoline will damage the three-way catalyst.

MRA8DE engine model

Except for Thailand and Iraq:

Use UNLEADED REGULAR gasoline with an octane rating of at least 91 (RON).

For Thailand:

Use UNLEADED REGULAR gasoline or gasohol (up to E20*) with an octane rating of at least 91 (RON).

*: Gasohol is alcohol blended gasoline. For example, "E20" is a mixture of approximately 20% fuel ethanol and 80% unleaded gasoline.

For Iraq:

Use UNLEADED PREMIUM gasoline with an octane rating of at least 91 (RON).

MR16DDT engine model

Except for Thailand:

Use UNLEADED PREMIUM gasoline with an octane rating of at least 95 (RON).

If unleaded premium gasoline is not used, UNLEADED REGULAR gasoline with an octane rating of at least 91 (RON) may be used at slightly reduced performance. However, for maximum vehicle performance and the best driveability, the use of unleaded premium gasoline is recommended.

For Thailand:

Use UNLEADED gasoline or gasohol (up to E10*) with an octane rating of at least 95 (RON).

If unleaded gasoline or gasohol (up to E10*) with an octane rating of at least 95 (RON) is not used, UNLEADED gasoline with an octane rating of at least 91 (RON) may be used at slightly reduced performance. However, for maximum vehicle performance and the best driveability, the use of unleaded gasoline or gasohol (up to E10*) with an octane rating of at least 95 (RON) is recommended.

*: Gasohol is alcohol blended gasoline. For example, "E10" is a mixture of approximately 10% fuel ethanol and 90% unleaded gasoline.

HR16DE engine model

Except for Thailand:

Use UNLEADED PREMIUM gasoline with an octane rating of at least 95 (RON).

If unleaded premium gasoline is not used, UNLEADED REGULAR gasoline with an octane rating of at least 91 (RON) may be used at slightly reduced performance. However, for maximum vehicle performance and the best driveability, the use of unleaded premium gasoline is recommended.

For Thailand:

Use UNLEADED PREMIUM gasoline or gasohol (up to E20*) with an octane rating of at least 95 (RON).

If unleaded premium gasoline is not used, UNLEADED REGULAR gasoline with an octane rating of at least 91 (RON) may be used at slightly reduced performance. However, for maximum vehicle performance and the best driveability, the use of unleaded premium gasoline is recommended.

*: Gasohol is alcohol blended gasoline. For example,

"E20" is a mixture of approximately 20% fuel ethanol and 80% unleaded gasoline.

RECOMMENDED SAE VISCOSITY NUMBER

MR16DDT engine model

5W-30 is preferable.

If 5W-30 is not available, select the viscosity, from the chart below, that is suitable for the outside temperature range.

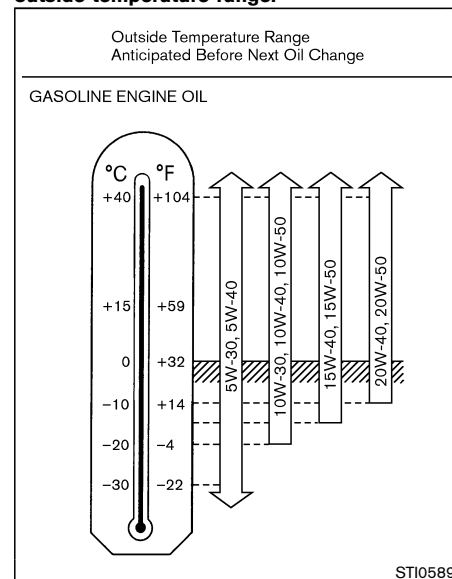

MRA8DE and HR16DE engine models

10W-30 is preferable.

If 10W-30 is not available, select the viscosity, from the chart below, that is suitable for the outside temperature range.

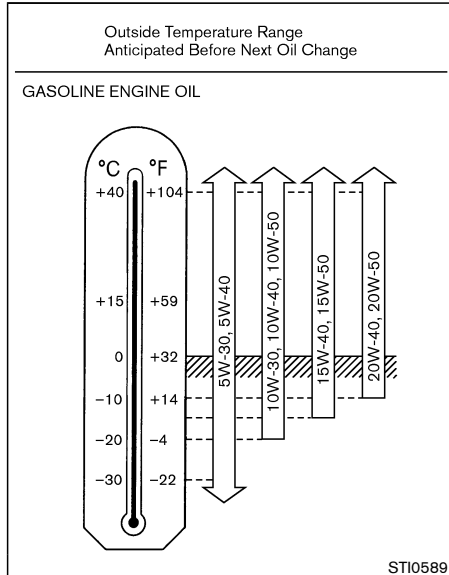

AIR CONDITIONER SYSTEM REFRIGERANT AND LUBRICANT

The air conditioner system of your vehicle must be charged with the refrigerant HFC-134a (R-134a) and the lubricant NISSAN A/C System Oil Type S (MRA8DE engine model) or Type R (MR16DDT and HR16DE engine model) or equivalents. Use of any other refrigerants or lubricants will cause severe damage, and you may need to replace your vehicle's entire air conditioner system.

The release of refrigerants into the atmosphere is prohibited in many countries and regions. The refrigerant HFC-134a (R-134a) in your vehicle will not harm the Earth's ozone layer. However, it may contribute in a small part to the global warming effect. NISSAN recommends that the refrigerant be appropriately recovered and recycled. Contact a NISSAN dealer when servicing the air conditioner system.

ENGINE

Engine model		MRA8DE	MR16DDT	HR16DE	
Type		Gasoline, 4-cycle, DOHC	Gasoline, 4-cycle, DOHC	Gasoline, 4-cycle, DOHC	
Cylinder arrangement		4-cylinder, in-line	4-cylinder, in-line	4-cylinder, in-line	
Bore × Stroke	mm (in)	79.7 × 90.1 (3.138 × 3.547)	79.7 × 81.1 (3.138 × 3.193)	78.0 × 83.6 (3.071 × 3.291)	
Displacement	cm ³ (cu in)	1,798 (109.71)	1,618 (98.78)	1,598 (97.51)	
Idle speed at the "N" (Neutral) position	rpm	700±50	650±50	650±50	
Ignition timing (B.T.D.C.) at the "N" (Neutral) position	degree at idle	MT: 8±2° CVT: 8±2°	MT: 6±2° CVT: 8±2°	MT: 10±2° CVT: 9±2°	
Spark plugs					
	Type	Standard	PLZKAR6A-11D*1 LZKAR6AP-11*2	DILKAR7C9H	PLZKAR6A-11D*1 LZKAR6AP-11*2
	Gap	mm (in)	1.1 (0.043)	0.9 (0.035)	1.1 (0.043)
Camshaft operation		Timing chain	Timing chain	Timing chain	
Maximum vehicle speed (for Gulf standard models)*3					
	CVT: km/h (MPH)	180 (111)	-	175 (108)	
	MT: km/h (MPH)	-	-	187 (116)	

*1: For Thailand

*2: Except for Thailand

*3: Gulf Standard requires automobile manufacturers to indicate the maximum vehicle speed for applicable models. The maximum vehicle speed, listed above, is the measured speed under certain testing conditions. The actual value may differ according to the vehicle usage and road and environmental conditions. NISSAN recommends you to ALWAYS observe posted speed limits and never drive too fast for conditions.

TIRES AND WHEELS

Standard		Spare	
Tire size	195/65R15 91H	195/65R15 91H	
	195/60R16 89H	195/60R16 89H	
	205/50R17 89V	205/50R17 89V	

		Size	Offset mm (in)
Road wheel	Aluminum	16 × 6 1/2J	40 (1.57)
		17 × 6 1/2J	45 (1.77)
	Steel	15 × 5 1/2JJ	40 (1.57)
Spare	Steel	15 × 5 1/2JJ	40 (1.57)
		16 × 6 1/2JJ	40 (1.57)
		17 × 6 1/2J	45 (1.77)

DIMENSIONS

Unit: mm (in)	
Overall length	4,295 (169.1)*1
	4,305 (169.5)*2*3*4
Overall width	1,760 (69.3)
Overall height	1,520 (59.8)*1*2*3
	1,525 (60.0)*4
Front tread	1,530 (60.2)*5
	1,540 (60.6)*6
Rear tread	1,530 (60.2)*5
	1,540 (60.6)*6
Wheelbase	2,700 (106.3)

*1: For Thailand, Australia and New Zealand

*2: For the Middle East

*3: For Singapore

*4: For Egypt

*5: For 17-inch wheel model

*6: Except for 17-inch wheel model

WHEN TRAVELLING OR REGISTERING IN ANOTHER COUNTRY

When planning to travel in another country or region, find out whether the fuel required for your vehicle is available in that country or region. Using a low octane rated fuel may cause engine damage. Therefore, be sure that the required fuel is available wherever you go. For additional information regarding recommended fuel, see earlier in this section.

When transferring the registration of your vehicle to another country, state, province or district, contact the appropriate authorities to find out that the vehicle complies with the local legal requirements. In some cases, a vehicle cannot meet the legal requirements, and it may be necessary to modify the vehicle to meet local laws and regulations. In addition, there may be possibilities that a vehicle cannot be adapted in certain areas.

The laws and regulations for motor vehicle emission control and safety standards vary according to the country, state, province or district; therefore, the vehicle specification may differ.

When any vehicles are to be taken into another country, state, province or district, its modification, transportation, registration, and any other expenses which may result, are the responsibility of the user. NISSAN is not responsible for any inconveniences that may result.

VEHICLE IDENTIFICATION

It is prohibited to cover, paint, weld, cut, drill, alter or remove Vehicle Identification Number (VIN).

VEHICLE IDENTIFICATION PLATE

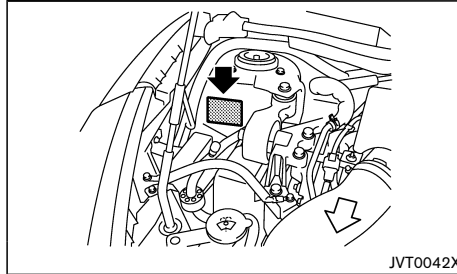

The plate is affixed as shown.

Built date plate (for Australia and New Zealand)

Built date is stamped on the vehicle identification plate.

The built date means the calendar month and the year in which the body shell and power train subassemblies are conjoined and the vehicle is driven or moved from the production line.

VEHICLE IDENTIFICATION NUMBER (VIN) PLATE (if equipped)

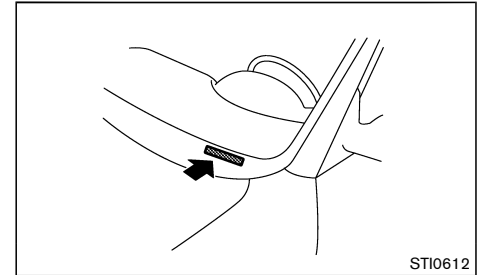

The vehicle identification number plate is attached as shown. This number is the identification for your vehicle and is used in the vehicle registration.

VEHICLE IDENTIFICATION NUMBER (chassis number)

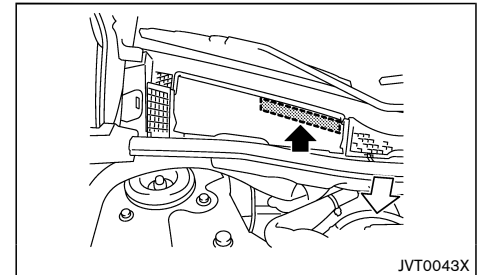

The vehicle identification number is located as shown. Remove the cover to access the number.

ENGINE SERIAL NUMBER

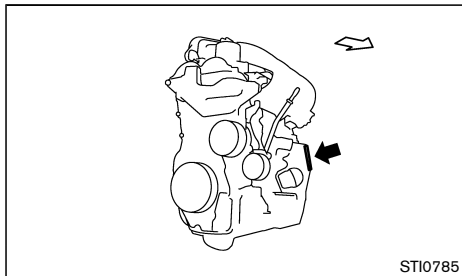

MRA8DE / HR16DE / MR16DDT engine

The engine serial number is stamped on the engine as shown.

CERTIFICATION LABEL (if equipped)

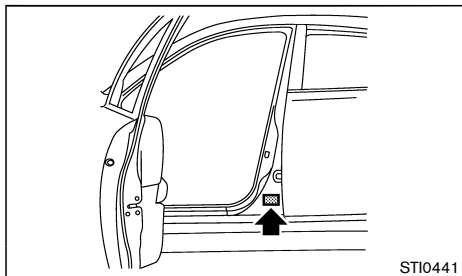

TIRE PLACARD

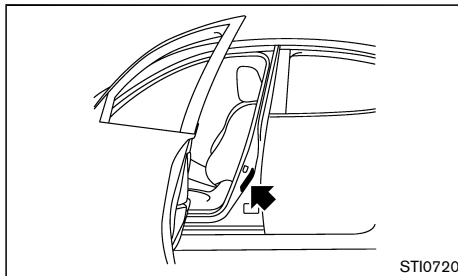

The cold tire pressures are shown on the tire placard affixed to the driver's side center pillar.

AIR CONDITIONER SPECIFICATION LABEL

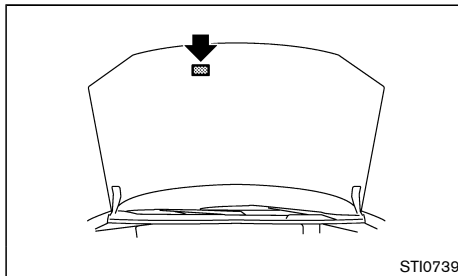

UNIFORM TIRE QUALITY GRADING (if equipped)

Quality Grades: All passenger car tires must conform to local safety requirements in addition to these grades.

Quality grades can be found where applicable on the tire sidewall between tread shoulder and maximum section width. For example:

Treadwear 200 Traction AA Temperature A

TREADWEAR

The treadwear grade is a comparative rating based on the wear rate of the tire when tested under controlled conditions on a specified government test course. For example, a tire graded 150 would wear one and one-half (1 1/2) times as well on the government course as a tire graded 100. The relative performance of tires depends upon the actual conditions of their use, however, and may depart significantly from the norm due to variations in driving habits, service practices and differences in road characteristics and climate.

TRACTION AA, A, B AND C

The traction grades, from highest to lowest, are AA, A, B, and C. Those grades represent the tire's ability to stop on wet pavement as measured under controlled conditions on specified government test surfaces of asphalt and concrete. A tire marked C may have poor traction performance.



WARNING:

The traction grade assigned to this tire is based on straight-ahead braking traction tests, and does not include acceleration, cornering, hydroplaning, or peak traction characteristics.

RADIO APPROVAL NUMBER AND INFORMATION

TEMPERATURE A, B AND C

The temperature grades are A (the highest), B, and C, representing the tire's resistance to the generation of heat and its ability to dissipate heat when tested under controlled conditions on a specified indoor laboratory test wheel. Sustained high temperature can cause the material of the tire to degenerate and reduce tire life, and excessive temperature can lead to sudden tire failure. The grade C corresponds to a level of performance which all passenger car tires must meet under the local regulations. Grades B and A represent higher levels of performance on the laboratory test wheel than the minimum required by law.



WARNING:

The temperature grade for this tire is established for a tire that is properly inflated and not overloaded. Excessive speed, under-inflation, or excessive loading, either separately or in combination, can cause heat build-up and possible tire failure.

FOR SINGAPORE

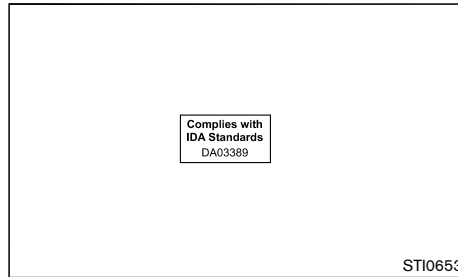

- NISSAN Anti-Theft System (NATS) immobilizer
- Remote keyless entry system (if equipped)
- Intelligent Key system (if equipped)

FOR NIGERIA



- Remote keyless entry system
- Intelligent Key system (if equipped)
- NISSAN Anti-Theft System (NATS) immobilizer

FOR JORDAN

Remote keyless entry system (if equipped)

Manufacturer:

ALPS ELECTRIC CO.,LTD.

Model:

TWC1G124

Type approval No.:

TRC/LPD/2008/125

Intelligent Key system (if equipped)

Manufacturer:

ALPS ELECTRIC CO.,LTD.

Model:

TWC1G154

Type approval No.:

TRC/LPD/2010/7

NISSAN Anti-Theft System (NATS) immobilizer

Manufacturer:

ALPS ELECTRIC CO.,LTD.

Model:

TWK1A002

Type approval No.:

TRC/LPD/2013/3

10 Index

A

ABS (Anti-lock Braking System).....	5-23
Adjusting the time.....	4-23
Aiming control, Headlights.....	2-19
Air bag system	
Supplemental curtain side-impact air bag system.....	1-18, 1-23
Supplemental front-impact air bag system.....	1-18, 1-23
Supplemental side-impact air bag system.....	1-18, 1-23
Air conditioner	
Air conditioner operation.....	4-6
Air conditioner service.....	4-10
Air conditioner specification label.....	9-9
Air conditioning system refrigerant and lubricant recommendations.....	4-10
Antenna.....	4-18
Anti-lock Braking System (ABS).....	5-23
Anti-lock braking system (ABS) warning light....	2-12
Appearance care	
Exterior appearance care.....	7-2
Interior appearance care.....	7-3
Armrest.....	1-4
Ashtray.....	2-25
Audible reminders.....	2-16
Audio operation precautions.....	4-11
Audio system.....	4-11

B

Back door.....	3-15
Battery.....	8-3, 8-18
Battery replacement, Intelligent Key.....	8-20
Battery saver system.....	2-18
Remote controller	
battery replacement.....	8-19, 8-20
Bluetooth® Hands-Free Phone System.....	4-29

Brake	
Anti-lock Braking System (ABS).....	5-23
Brake booster.....	8-13
Brake fluid.....	8-13
Brake system.....	5-22
Parking brake check.....	8-12
Parking brake operation.....	5-25
Warning light.....	2-12
Break-in schedule.....	5-2
Brightness control, Instrument panel.....	2-7
Bulb check/instrument panel.....	2-12
Bulb replacement.....	8-2, 8-23

C

Car phone or CB radio.....	4-29
Cargo cover.....	2-28
Catalytic converter, Three way catalyst.....	5-3
Child restraints.....	1-12
Child safety.....	1-8
Child safety rear door lock.....	3-5
Chimes, Audible reminders.....	2-16
Cigarette lighter.....	2-25
Circuit breaker, Fusible link.....	8-21
Cleaning exterior and interior.....	7-2, 7-3
Clock.....	4-23
Closing hood.....	3-15
Clutch fluid.....	8-14
Coat hook.....	2-28
Cockpit.....	2-2
Cold weather driving.....	5-24
Console box.....	2-26
Continuously variable transmission (CVT).....	5-4
Continuously Variable Transmission (CVT) fluid.....	8-15
Coolant	
Changing engine coolant.....	8-8
Checking engine coolant level.....	8-8
Corrosion protection.....	7-5
Cover, Cargo cover.....	2-28

Cruise control.....	5-16
Cruise control operations.....	5-16
Cup holders.....	2-27
CVT, Driving with CVT (Continuously Variable Transmission).....	5-6

D

Dimensions.....	9-7
Door open warning light.....	2-13
Drive belt.....	8-11
Driving	
Cold weather driving.....	5-24
Driving with CVT (Continuously Variable Transmission).....	5-6
Driving with Manual Transmission (MT).....	5-13
Precautions when starting and driving.....	5-2

E

Electric power steering system.....	5-22
Electric power steering warning light.....	2-13
Engine	
Break-in schedule.....	5-2
Changing engine coolant.....	8-8
Checking engine coolant level.....	8-8
Checking engine oil level.....	8-9
Coolant temperature gauge.....	2-7
Engine compartment check locations.....	8-5
Engine cooling system.....	8-7
Engine oil.....	8-9
Engine serial number.....	9-9
Engine specifications.....	9-6
If your vehicle overheats.....	6-7
Exhaust gas (carbon monoxide).....	5-3

F

Flat tire.....	6-2
Floor mat cleaning.....	7-4

Fluid	
Brake fluid.....	8-13
Clutch fluid.....	8-14
Continuously Variable Transmission (CVT) fluid.....	8-15
Engine coolant.....	8-7
Engine oil.....	8-9
Window washer fluid.....	8-4, 8-17
FM-AM radio with Compact Disc (CD) player....	4-19
FM-AM radio with compact disc (CD) player (with color display).....	4-22
Fog light switch.....	2-19
Front seat, Front seat adjustment.....	1-2
Fuel	
Fuel information.....	9-4
Fuel octane rating.....	9-4
Gauge.....	2-7
Fuses.....	8-21
Fusible links.....	8-21

G

Gauge.....	2-6
Engine coolant temperature gauge.....	2-7
Fuel gauge.....	2-7
Tachometer.....	2-6
Trip computer.....	2-8
General maintenance.....	8-2
Glove box.....	2-26

H

Hands-Free Phone System, Bluetooth®	4-29
Head restraints.....	1-5
Headlights	
Aiming control.....	2-19
Bulb replacement.....	8-23
Headlight switch.....	2-17
Xenon headlights.....	2-17
Heater	
Heater and air conditioner operation.....	4-6

Hood release.....	3-14
Horn.....	2-22

I

Ignition switch	
(with Intelligent Key system).....	5-5
(without Intelligent Key system).....	5-4
Key positions.....	5-5
Indicator lights.....	2-14
Instrument brightness control.....	2-7
Instrument panel.....	2-4
Intelligent Key.....	3-2
Intelligent Key system.....	3-7
Intelligent Key system warning light.....	2-13
P position selecting warning light.....	2-13
Interior lights.....	2-29
iPod player operation.....	4-26

J

Jump starting.....	6-5
--------------------	-----

K

Keyless entry (See remote keyless entry system).....	3-5
Keys.....	3-2
For Intelligent Key system.....	3-7

L

Labels	
Air conditioner specification label.....	9-9
Engine serial number.....	9-9
Vehicle identification number (VIN).....	9-8
Legal requirement to adjust headlight beam.....	8-29
Light	
Bulb replacement.....	8-2, 8-23
Fog light switch.....	2-19
Headlight switch.....	2-17

Headlights bulb replacement.....	8-23
Indicator lights.....	2-14
Interior lights.....	2-29
Map lights.....	2-30
Replacement.....	8-2, 8-23
Room light.....	2-29
Vanity mirror lights.....	2-30
Warning/indicator lights and audible reminders.....	2-12
Xenon headlights.....	2-17
Lock	
Back door lock.....	3-15
Vehicle speed sensing door lock mechanism.....	3-4
Low fuel warning light.....	2-13
Low washer fluid warning light.....	2-13
Luggage hooks.....	2-29

M

Maintenance	
Battery.....	8-3, 8-18
General maintenance.....	8-2
Maintenance precautions.....	8-4
Maintenance requirements.....	8-2
Seat belt maintenance.....	1-11
Malfunction indicator light (MIL).....	2-15
Manual air conditioner.....	4-7
Manual transmission (MT).....	5-4
Map lights.....	2-30
Maximum load limits.....	5-20
Mechanical key (Intelligent Key system).....	3-3
Meter, Trip computer.....	2-8
Meters and gauges.....	2-6
Instrument brightness control.....	2-7
Mirror, Vanity mirror.....	3-19
Monitor, Rearview Monitor.....	4-2

N

New vehicle break-in.....	5-2
NISSAN Anti-Theft System (NATS) key.....	3-2

O

Oil	
Checking engine oil level.....	8-9
Engine oil.....	8-9
Operating precautions.....	5-20
Outside air temperature display.....	2-8
Overheat, If your vehicle overheats.....	6-7

P

Panic alarm.....	3-12
Parking	
Brake break-in.....	5-23
Parking brake operation.....	5-25
Phone, Bluetooth® Hands-Free	
Phone System.....	4-29
Phone, Car phone or CB radio.....	4-29
Power	
Electric power steering system.....	5-22
Power outlet.....	2-25
Power windows.....	2-22
Precautions	
Audio operation.....	4-11
Cruise control.....	5-16
Maintenance.....	8-4
Seat belt usage.....	1-7
Supplemental restraint system.....	1-18
When starting and driving.....	5-2
Pre-tensioner seat belt system.....	1-21, 1-26
Push starting.....	6-7
Push-button ignition switch.....	5-5

R

Radio.....	4-11
Car phone or CB radio.....	4-29
FM-AM radio with Compact Disc (CD) player.....	4-19
FM-AM radio with Compact Disc (CD) player (with color display).....	4-22
Rear door lock, Child safety rear door lock.....	3-5
Rear seats.....	1-3
Rearview Monitor.....	4-2
Remote keyless entry system.....	3-5
Room light.....	2-29

S

Safety chains.....	5-21
Safety, Child seat belts.....	1-8
Seat adjustment, Front seats.....	1-2
Seat belt(s)	
Child safety.....	1-8
Injured persons.....	1-9
Precautions on seat belt usage.....	1-7
Pregnant women.....	1-9
Pre-tensioner seat belt system.....	1-21, 1-26
Seat belt cleaning.....	7-4
Seat belt hooks.....	1-10
Seat belt maintenance.....	1-11
Seat belt warning light.....	2-14
Seat belts.....	1-7
Shoulder belt height adjustment.....	1-10
Seat(s), Seats.....	1-2
Servicing air conditioner.....	4-10
Shift lever, Shift lock release.....	5-12
Shift lock release	
Transmission.....	5-12
Shifting, CVT (Continuously Variable Transmission).....	5-6
Shoulder belt height adjustment.....	1-10
Side-impact air bag system.....	1-18, 1-23
Small light indicator light.....	2-15

Sonar system.....	5-19
Spare tire.....	8-32
Spark plugs.....	8-12
Speed [120 km/h (75 MPH)] warning light.....	2-14
SPORT mode switch.....	5-11
SRS air bag deployment conditions.....	1-24
Starting	
Jump starting.....	6-5
Precautions when starting and driving.....	5-2
Push starting.....	6-7
Steering	
Electric power steering system.....	5-22
Steering lock.....	5-5, 5-6
Tilting steering wheel.....	3-17
Sun visors.....	2-29
Sunglasses holder.....	2-27
Sunroof.....	2-24
Supplemental curtain side-impact air bag system.....	1-23
Supplemental front-impact air bag system.....	1-23
Supplemental side-impact air bag system.....	1-18, 1-23
Switch	
Audio control steering switch.....	4-28
Fog light switch.....	2-19
Headlight aiming control.....	2-19
Headlight switch.....	2-17
Power door lock switch.....	3-4
SPORT mode switch.....	5-11
Turn signal switch.....	2-19

T

Tachometer.....	2-6
Temperature display.....	2-8
Temperature gauge, Engine coolant temperature gauge.....	2-7
Three-way catalyst.....	5-3
Tilting steering wheel.....	3-17
Tire pressure.....	5-21
Tires	
Flat tire.....	6-2

Tire chains.....	8-31
Tire rotation.....	8-3, 8-31
Types of tires.....	8-31
Uniform Tire Quality Grading.....	9-9
Tires and wheels.....	8-31, 9-7
Tonneau cover (see cargo cover).....	2-28
Towing, Tow truck towing.....	6-8
Trailer brakes.....	5-21
Trailer detection.....	5-21
Trailer towing.....	5-20
Transmission	
Continuously Variable Transmission (CVT) fluid.....	8-15
Driving with CVT (Continuously Variable Transmission).....	5-6
Driving with Manual Transmission (MT).....	5-13
Transmission shift lever lock release.....	5-12
Transmitter (See remote keyless entry system)....	3-5
Trip computer.....	2-8
Turn signal switch.....	2-19

U

Underbody cleaning.....	7-3
Uniform Tire Quality Grading.....	9-9
USB memory operation.....	4-25

V

Vanity mirror.....	3-19
Vanity mirror lights.....	2-30
Variable voltage control system.....	8-21
Vehicle	
Dimensions.....	9-7
Identification number (VIN).....	9-8
Information display.....	2-8
Speed sensing door lock mechanism.....	3-4
Vehicle dynamic control (VDC) system.....	5-14
Vehicle Dynamic Control (VDC) OFF switch.....	5-15
Ventilators.....	4-5

W

Warning	
Lights.....	2-12
Warning/indicator lights and audible reminders.....	2-11
Warning light	
Anti-lock braking system (ABS) warning light.....	2-12
Brake warning light.....	2-12
Door open warning light.....	2-13
Electric power steering warning light.....	2-13
Intelligent Key system warning light.....	2-13
Low fuel warning light.....	2-13
Low washer fluid warning light.....	2-13
Seat belt warning light.....	2-14
Speed [120 km/h (75 MPH)] warning light... ..	2-14
Washer switch, Windshield wiper and washer switch.....	2-20
Washing.....	7-2
Waxing.....	7-2
Wheels and tires	
Care of wheels.....	7-3
Cleaning aluminum alloy wheels.....	7-3
Window washer fluid.....	8-4, 8-17
Window(s)	
Cleaning.....	7-2, 7-4
Power windows.....	2-22
Windshield wiper and washer switch.....	2-20
Wiper	
Rear window wiper blade.....	8-16
Windshield wiper and washer switch.....	2-20
Wiper blades.....	8-15

X

Xenon headlights.....	2-17
-----------------------	------

GAS STATION INFORMATION

FUEL INFORMATION



CAUTION:

Do not use leaded gasoline. Using leaded gasoline will damage the three-way catalyst.

MRA8DE engine model

Except for Thailand and Iraq:

Use UNLEADED REGULAR gasoline with an octane rating of at least 91 (RON).

For Thailand:

Use UNLEADED REGULAR gasoline or gasohol (up to E20*) with an octane rating of at least 91 (RON).

*: Gasohol is alcohol blended gasoline. For example, "E20" is a mixture of approximately 20% fuel ethanol and 80% unleaded gasoline.

For Iraq:

Use UNLEADED PREMIUM gasoline with an octane rating of at least 91 (RON).

MR16DDT engine model

Except for Thailand:

Use UNLEADED PREMIUM gasoline with an octane rating of at least 95 (RON).

If unleaded premium gasoline is not used, UNLEADED REGULAR gasoline with an octane rating of at least 91 (RON) may be used at slightly reduced performance. However, for maximum vehicle performance and the best driveability, the use of unleaded premium gasoline is recommended.

For Thailand:

Use UNLEADED gasoline or gasohol (up to E10*) with an octane rating of at least 95 (RON).

If unleaded gasoline or gasohol (up to E10*) with an octane rating of at least 95 (RON) is not used, UNLEADED gasoline with an octane rating of at least 91 (RON) may be used at slightly reduced performance. However, for maximum vehicle performance and the best driveability, the use of unleaded gasoline or gasohol (up to E10*) with an octane rating of at least 95 (RON) is recommended.

*: Gasohol is alcohol blended gasoline. For example, "E10" is a mixture of approximately 10% fuel ethanol and 90% unleaded gasoline.

HR16DE engine model

Except for Thailand:

Use UNLEADED PREMIUM gasoline with an octane rating of at least 95 (RON).

If unleaded premium gasoline is not used, UNLEADED REGULAR gasoline with an octane rating of at least 91 (RON) may be used at slightly reduced performance. However, for maximum vehicle performance and the best driveability, the use of unleaded premium gasoline is recommended.

For Thailand:

Use UNLEADED PREMIUM gasoline or gasohol (up to E20*) with an octane rating of at least 95 (RON).

If unleaded premium gasoline is not used, UNLEADED REGULAR gasoline with an octane rating of at least 91 (RON) may be used at slightly reduced performance. However, for maximum vehicle performance and the best driveability, the use of unleaded premium gasoline is recommended.

*: Gasohol is alcohol blended gasoline. For example, "E20" is a mixture of approximately 20% fuel ethanol and 80% unleaded gasoline.

RECOMMENDED ENGINE OIL

See "Recommended fluids/lubricants and capacities" (P.9-2).

- Genuine NISSAN engine oil
- API grade: SL, SM or SN
- ILSAC grade: GF-3, GF-4 or GF-5

TIRE COLD PRESSURE

See the tire placard affixed to the driver's side center pillar.

QUICK REFERENCE

- In case of emergency ... 6-1
(Flat tire, engine will not start, overheating, towing)
- How to start the engine ... 5-1
- How to read the meters and gauges ... 2-1
- Maintenance and do-it-yourself ... 8-1
- Technical information ... 9-1